

MOTORS

IEC GENERAL PURPOSE

W22 CAST IRON TEFC
W21 ALUMINIUM TEFC
W21 CAST IRON TEFC
W40 CAST IRON ODP
W21 BRAKE CAST IRON TEFC
W22 SPARES
W21 SPARES

IEC HAZARDOUS AREA APPLICATION

W22 DUST IGNITION PROOF Ex tb (Zone 21)
W22 INCREASED SAFETY Ex ec (Zone 2)
W21 EXPLOSION PROOF Ex d (Zone 1)

SINGLE PHASE

W22 IEC CAST IRON
W01 NEMA FRAME (IP21)
W01 NEMA FRAME (IP55)
W22 IEC DUAL VOLTAGE

W22 CAST IRON TEFC

Our flagship range of high efficiency motors will drive down your energy bill and maintenance costs, providing long life operation.



Range 0.12kW to 500kW



2, 4, 6 and 8 Pole



Improved Thermal Performance



Highly Reliable



MEPS High Efficiency Compliant



Electrical

- Class "H" insulation ("B" temperature rise: 80 K)
Unless otherwise indicated
- Ambient temperature: 40 °C at 1000 masl
- Voltages: 220-240/380-415//440-460 V - 50 Hz (up to 100L)//380-415/660//440-460 V - 50 Hz (112M up to frame 355) 400 V (frame 355A/B) //440-460 V - 60 Hz
- Service Factor (SF): 1.15
- Design: N
- Continuous duty: S1
- Terminal block (6 pins)
- Thermistors for alarm 155 °C (1/phase) (frame 160 up to 200)
- Thermistors for disconnection 180 °C (1/phase) (frame 225 and up)
- Dip and baked impregnation (up to frame 200)
- Resin continuous flow impregnation (frame 225 and up)

Mechanical

- Squirrel cage rotor (Aluminium die cast)
- Enclosure: TEFC (totally enclosed fan cooled)
- Mounting: B3R(E)
- Ball bearings
- Grease nipple system
- Shaft material: AISI 1040/45 (up to frame 315S/M) and AISI 4140 (315L, 355M/L and 355A/B)
- Metric threaded cable entries
- Solid and integrated feet
- Single grounding up to frames 200L
- Double grounding (1 inside terminal box and 1 at the frame) for frames 255S/M and above
- Wseal (frame 225 and up)
- Oil seal double lips (frame 63 up to 200)
- Insulated bearing housing at NDE for frames 315 and 355



2 POLE

3000 RPM Three Phase Cast Iron Frame TEFC, W22 High Efficiency "IE3" IP66

Multivoltage 380 - 415 Volt 50HZ, 63 to 355 Frame WISE© Insulation System Class "H" Insulation

160 to 200 Frame 1 x PTC Thermistor per Phase, 225 to 355 Frame 2 x PTC Thermistors per Phase

160 Frame & Above Fitted with Grease Nipple & Grease Release Valve

PART NUMBER	KW	HP	RPM	FRAME	WEIGHT KG	FLC AMPS	SHAFT SIZE	TRADE PRICE		
								B3 FOOT	B14, B5, V1 FLANGE ONLY	B34, B35 FT & FLANGE
W2000012	0.12	0.16	2820	63	7	0.375	11mm j6	\$582.00		\$636.00
W2000018	0.18	0.25	2860	63	8	0.533	11mm j6	\$582.00		\$636.00
W2000025	0.25	0.33	2805	63	7.9	0.672	11mm j6	\$618.00		\$674.00
W2000037	0.37	0.5	2820	71	10.5	0.851	14mm j6	\$709.00	\$741.00	\$773.00
W2000055	0.55	0.75	2830	71	11	1.19	14mm j6	\$709.00	\$741.00	\$773.00
W2000075	0.75	1	2860	80	14.1	1.65	19mm j6	\$881.00	\$923.00	\$962.00
W2000110	1.1	1.5	2835	80	15	2.39	19mm j6	\$963.00	\$1,007.00	\$1,046.00
W2000150	1.5	2	2885	90S	21.5	3.17	24mm j6	\$1,082.00	\$1,132.00	\$1,179.00
W2000220	2.2	3	2870	90L	24.5	4.43	24mm j6	\$1,214.00	\$1,271.00	\$1,324.00
W2000300	3	4	2900	100L	35	5.78	28mm j6	\$1,619.00	\$1,693.00	\$1,764.00
W2000400R	4	5.5	2900	100L	37	7.82	28mm j6	\$1,828.00		\$1,991.00
W2000400	4	5.5	2900	112M	41	7.59	28mm j6	\$1,888.00	\$1,976.00	\$2,059.00
W2000550R	5.5	7.5	2880	112M	46	10.5	28mm j6	\$2,308.00		\$2,514.00
W2000550	5.5	7.5	2940	132S	62	10.6	38mm k6	\$2,452.00	\$2,564.00	\$2,671.00
W2000750	7.5	10	2925	132S	70	14.1	38mm k6	\$2,753.00	\$2,880.00	\$3,000.00
W2001100R	11	15	2925	132M	84	19.6	38mm k6	\$4,190.00		\$4,567.00
W2001100	11	15	2950	160M	115	20.4	42mm k6	\$4,241.00	\$4,436.00	\$4,621.00
W2001500	15	20	2945	160M	120	27.7	42mm k6	\$5,034.00	\$5,268.00	\$5,489.00
W2001850	18.5	25	2945	160L	135	33.9	42mm k6	\$5,951.00	\$6,229.00	\$6,488.00
W2002200	22	30	2960	180M	170	39.8	48mm k6	\$7,434.00	\$7,780.00	\$8,103.00
W2003000	30	40	2965	200L	235	54.5	55mm m6	\$9,185.00		\$10,010.00
W2003700	37	50	2960	200L	250	67.8	55mm m6	POA		POA
W2004500	45	60	2960	225S/M	380	77.5	55mm m6	POA		POA
W2005500	55	75	2965	250S/M	460	97.8	60mm m6	POA		POA
W2007500	75	100	2965	250S/M	500	128	60mm m6	POA		POA
W2009000	90	125	2976	280S/M	710	153	65mm m6	POA		POA
W2011000	110	150	2976	280S/M	790	187	65mm m6	POA		POA
W2013200	132	175	2980	315S/M	950	224	65mm m6	POA		POA
W2015000	150	200	2979	315S/M	1050	254	65mm m6	POA		POA
W2018500	185	250	2978	315S/M	1110	317	65mm m6	POA		POA
W2020000	200	270	2975	315S/M	1200	334	65mm m6	POA		POA
W2022000	220	300	2985	355M/L	1600	363	75mm m6	POA		POA
W2025000	250	340	2984	355M/L	1750	413	75mm m6	POA		POA
W2028000	280	380	2985	355M/L	1800	468	75mm m6	POA		POA
W2031500	315	430	2983	355M/L	1950	520	75mm m6	POA		POA

LARGER MOTORS ARE AVAILABLE ON REQUEST



4 POLE

1500 RPM Three Phase Cast Iron Frame TEFC, W22 High Efficiency "IE3" IP66

Multivoltage 380 - 415 Volt 50HZ, 63 to 355 Frame WISE© Insulation System Class "H" Insulation

160 to 200 Frame 1 x PTC Thermistor per Phase, 225 to 355 Frame 2 x PTC Thermistors per Phase

160 Frame & Above Fitted with Grease Nipple & Grease Release Valve

PART NUMBER	KW	HP	RPM	FRAME	WEIGHT KG	FLC AMPS	SHAFT SIZE	TRADE PRICE		
								B3 FOOT	B14, B5, V1 FLANGE ONLY	B34, B35 FT & FLANGE
W400012	0.12	0.16	1370	63	7	0.366	11mm j6	\$550.00		\$598.00
W400018	0.18	0.25	1380	63	8	0.516	11mm j6	\$550.00	\$575.00	\$598.00
W400025	0.25	0.33	1410	71	8	0.682	14mm j6	\$574.00	\$599.00	\$624.00
W400037	0.37	0.5	1385	71	9.5	0.987	14mm j6	\$582.00	\$611.00	\$636.00
W400055	0.55	0.75	1425	80	12.5	1.23	19mm j6	\$703.00	\$735.00	\$765.00
W400075	0.75	1	1435	L80	14.5	1.68	19mm j6	\$808.00	\$846.00	\$881.00
W400110	1.1	1.5	1445	90S	19.5	2.35	24mm j6	\$984.00	\$1,031.00	\$1,073.00
W400150	1.5	2	1445	90L	23	3.21	24mm j6	\$1,107.00	\$1,158.00	\$1,205.00
W400220	2.2	3	1435	100L	31.5	4.62	28mm j6	\$1,361.00	\$1,421.00	\$1,482.00
W400300	3	4	1440	L100L	37.5	6.15	28mm j6	\$1,576.00	\$1,649.00	\$1,720.00
W400400	4	5.5	1450	112M	44	8.34	28mm j6	\$1,964.00	\$2,057.00	\$2,141.00
W400550	5.5	7.5	1465	132S	66	10.5	38mm k6	\$2,551.00	\$2,669.00	\$2,779.00
W400750	7.5	10	1460	132M	74	14.2	38mm k6	\$3,009.00	\$3,151.00	\$3,280.00
W400920	9.2	12.5	1465	132M/L	82	17.8	38mm k6	\$3,783.00		\$4,123.00
W4001100	11	15	1475	160M	113	20.9	42mm k6	\$4,372.00	\$4,576.00	\$4,764.00
W4001500	15	20	1470	160L	140	28.3	42mm k6	\$4,996.00		\$5,442.00
W4001850	18.5	25	1470	180M	188	35.2	48mm k6	\$6,783.00		\$7,394.00
W4002200	22	30	1470	180L	185	41	48mm k6	\$7,572.00		\$8,254.00
W4003000	30	40	1480	200L	228	57.1	55mm m6	\$9,413.00		\$10,262.00
W4003700	37	50	1480	225S/M	365	69.2	60mm m6	POA		POA
W4004500	45	60	1480	225S/M	400	81.9	60mm m6	POA		POA
W4005500	55	75	1480	250S/M	500	98.6	70mm m6	POA		POA
W4007500	75	100	1480	250S/M	530	131	70mm m6	POA		POA
W4009000	90	125	1485	280S/M	700	160	80mm m6	POA		POA
W4011000	110	150	1485	280S/M	800	195	80mm m6	POA		POA
W4013200	132	175	1490	315S/M	1010	231	85mm m6	POA		POA
W4015000	150	200	1490	315S/M	1030	266	85mm m6	POA		POA
W4018500	185	250	1491	315S/M	1150	327	85mm m6	POA		POA
W4020000	200	270	1488	315S/M	1250	346	85mm m6	POA		POA
W4022000	220	300	1492	355M/L	1510	393	100mm m6	POA		POA
W4025000	250	340	1490	355M/L	1555	436	100mm m6	POA		POA
W4028000	280	380	1490	355M/L	1600	488	100mm m6	POA		POA
W4030000	300	400	1490	355M/L	1650	530	100mm m6	POA		POA
W4031500	315	430	1491	355M/L	1750	562	100mm m6	POA		POA
W4033000	330	450	1490	355M/L	1810	583	100mm m6	POA		POA
W4035500	355	480	1490	355M/L	1878	618	100mm m6	POA		POA

LARGER MOTORS ARE AVAILABLE ON REQUEST



6 POLE

1000 RPM Three Phase Cast Iron Frame TEFC, W22 High Efficiency "IE3" IP66

Multivoltage 380 - 415 Volt 50HZ, 63 to 355 Frame WISE© Insulation System Class "H" Insulation

160 to 200 Frame 1 x PTC Thermistor per Phase, 225 to 355 Frame 2 x PTC Thermistors per Phase

160 Frame & Above Fitted with Grease Nipple & Grease Release Valve

PART NUMBER	KW	HP	RPM	FRAME	WEIGHT KG	FLC AMPS	SHAFT SIZE	TRADE PRICE		
								B3 FOOT	B14, B5, V1 FLANGE ONLY	B34, B35 FT & FLANGE
W6000025	0.25	0.33	890	71	12	0.76	14mm j6	\$785.00		\$856.00
W6000037	0.37	0.5	925	80	12.5	0.969	19mm j6	\$798.00		\$868.00
W6000055	0.55	0.75	945	L80	15.5	1.49	19mm j6	\$911.00		\$994.00
W6000075	0.75	1	950	L90S	22	1.93	24mm j6	\$1,070.00		\$1,165.00
W6000110	1.1	1.5	935	90L	25.3	2.78	24mm j6	\$1,259.00		\$1,370.00
W6000150	1.5	2	955	100L	32	3.7	28mm j6	\$1,482.00		\$1,618.00
W6000220	2.2	3	960	112M	46	5.29	28mm j6	\$1,768.00		\$1,927.00
W6000300	3	4	970	132S	65	6.93	38mm k6	\$2,592.00		\$2,825.00
W6000400	4	5.5	965	132M	70	9.11	38mm k6	\$2,955.00		\$3,221.00
W6000550	5.5	7.5	970	132M/L	78	12.9	38mm k6	\$3,462.00		\$3,772.00
W6000750	7.5	10	975	160M	118	15.2	42mm k6	\$4,048.00		\$4,413.00
W6001100	11	15	978	160L	140	22.8	42mm k6	\$5,630.00		\$6,139.00
W6001500	15	20	977	180L	185	28.2	48mm k6	\$7,366.00		\$8,029.00
W6001850	18.5	25	980	200L	215	35.9	55mm m6	\$9,680.00		\$10,552.00
W6002200	22	30	980	200L	225	42.4	55mm m6	\$11,556.00		\$12,596.00
W6003000	30	40	980	225S/M	380	56	60mm m6	\$15,566.00		\$16,969.00
W6003700	37	50	985	250S/M	430	67.2	70mm m6	POA		POA
W6004500	45	60	985	250S/M	490	79.5	70mm m6	POA		POA
W6005500	55	75	988	280S/M	665	103	80mm m6	POA		POA
W6007500	75	100	990	280S/M	725	141	80mm m6	POA		POA
W6009000	90	125	990	315S/M	990	165	85mm m6	POA		POA
W6011000	110	150	990	315S/M	1040	201	85mm m6	POA		POA
W6013200	132	175	992	315S/M	1100	243	85mm m6	POA		POA
W6015000	150	200	993	355M/L	1440	283	100mm m6	POA		POA
W6018500	185	250	994	355M/L	1550	362	100mm m6	POA		POA
W6022000	220	300	994	355M/L	1710	419	100mm m6	POA		POA
W6025000	250	340	993	355M/L	1830	476	100mm m6	POA		POA
W6030000	300	400	992	355M/L	2493	564	100mm m6	POA		POA

LARGER MOTORS ARE AVAILABLE ON REQUEST



8 POLE

750 RPM Three Phase Cast Iron Frame TEFC, W22 High Efficiency "IE3" IP66

Multivoltage 380 - 415 Volt 50HZ, 63 to 355 Frame WISE© Insulation System Class "H" Insulation

160 to 200 Frame 1 x PTC Thermistor per Phase, 225 to 355 Frame 2 x PTC Thermistors per Phase

160 Frame & Above Fitted with Grease Nipple & Grease Release Valve

PART NUMBER	KW	HP	RPM	FRAME	WEIGHT KG	FLC AMPS	SHAFT SIZE	TRADE PRICE		
								B3 FOOT	B14, B5, V1 FLANGE ONLY	B34, B35 FT & FLANGE
W8000025	0.25	0.33	695	80	14.5	0.894	19mmj6	\$1,093.00		\$1,189.00
W8000037	0.37	0.5	700	90S	19	1.24	24mm j6	\$1,127.00		\$1,228.00
W8000055	0.55	0.75	695	90L	23	1.62	24mm j6	\$1,217.00		\$1,327.00
W8000075	0.75	1	710	100L	30.5	2.31	28mm j6	\$1,597.00		\$1,741.00
W8000110	1.1	1.5	710	100L	33	3.3	28mm j6	\$1,792.00		\$1,951.00
W8000150	1.5	2	705	112M	43	3.98	28mm j6	\$2,019.00		\$2,204.00
W8000220	2.2	3	710	132S	69	5.37	38mm k6	\$2,803.00		\$3,052.00
W8000300	3	4	710	132M	75	7.2	38mm k6	\$3,259.00		\$3,551.00
W8000400	4	5.5	730	160M	114	9.87	42mm k6	\$3,874.00		\$4,222.00
W8000550	5.5	7.5	725	160M	123	12.5	42mm k6	\$4,930.00		\$5,375.00
W8000750	7.5	10	731	160L	145	18	42mm k6	\$5,327.00		\$5,807.00
W8001100	11	15	730	180L	185	23.3	48mm k6	\$7,452.00		\$8,125.00
W8001500	15	20	730	200L	220	32.5	55mm m6	\$9,384.00		\$10,228.00
W8001850	18.5	25	735	225S/M	377	36.5	60mm m6	\$15,830.00		\$17,254.00
W8002200	22	30	735	225S/M	402	44.3	60mm m6	\$17,226.00		\$18,777.00
W8003000	30	40	730	250S/M	490	57	70mm m6	\$18,385.00		\$20,040.00
W8003700	37	50	730	250S/M	550	73.5	70mm m6	POA		POA
W8004500	45	60	740	280S/M	720	89	80mm m6	POA		POA
W8005500	55	75	740	280S/M	812	111	80mm m6	POA		POA
W8007500	75	100	740	315S/M	1025	145	85mm m6	POA		POA
W8009000	90	125	742	315S/M	1100	173	85mm m6	POA		POA
W8011000	110	150	745	355M/L	1450	214	100mm m6	POA		POA
W8011000	132	175	745	355M/L	1587	256	100mm m6	POA		POA
W8013200	150	200	744	355M/L	1540	295	100mm m6	POA		POA
W8015000	185	250	745	355M/L	1819	361	100mm m6	POA		POA
W8018500	220	300	744	355M/L	2020	433	100mm m6	POA		POA

LARGER MOTORS ARE AVAILABLE ON REQUEST

W21 ALUMINIUM TEFC

Lighter, general-purpose motor with versatile mounting for use in everyday applications.

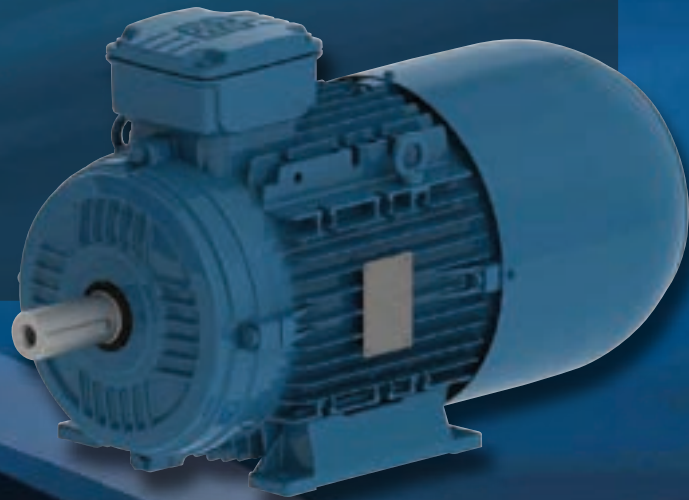

Range 0.12kW to 37kW



2, 4, 6 and 8 Pole



Full Aluminium Design



Lightweight



Modular Construction



Electrical:

- Class "F" insulation
("B" Temperature Rise: 80 K)
- Ambient temperature: 40 °C 1000 at masl
- Voltages: 220-240/380-415 V - 50 Hz
(up to frame 100L) 380-415/660-690 V - 50 Hz
(frame 112M and above)//440-460 V - 60 Hz
- Service Factor (SF): 1.00
- Design: N
- Continuous duty: S1
- Terminal block (6 pins)
- Thermistors (1/phase) from frame 160 and above
- Dip and baked impregnation

Mechanical:

- Squirrel cage rotor (Aluminium die Cast)
- Enclosure: TEFC (Totally Enclosed Fan Cooled)
- Mounting: B3R(E)
- V'ring seals
- Ball Bearing (ZZ up to 132)
- Grease nipple system in frame 160 and above
- Shaft material: AISI 1040/45 steel
- Automatic drain plug
- Metric thread cable entries



2 POLE

3000 RPM Three Phase IP55 TEFC, Multivoltage 380 - 415 Volt 50HZ

Frames 63-200 Aluminium, Frames 225-355 Cast Iron, Class "F" Insulation

11KW & Above Fitted With 1 x PTC Thermistor per Phase, 2 x PTC Thermistors per Phase 225 Frame & Above

160 Frame & Above Fitted with Grease Nipple & Grease Release Valve

Top Mount Terminal Box (Multi Mount ≤ 200 Frame)

PART NUMBER	KW	HP	RPM	FRAME	WEIGHT KG	FLC AMPS	SHAFT SIZE	TRADE PRICE		
								B3T FOOT	B14T or B5T FLANGE ONLY	B34T OR B35T FT & FLANGE
A2000012	0.12	0.16	2870	63	6.3	0.55	11mm j6	\$483.00	\$507.00	\$528.00
A2000018	0.18	0.25	2735	63	6.8	0.46	11mm j6	\$483.00	\$507.00	\$528.00
A2000025	0.25	0.33	2790	63	7	0.66	11mm j6	\$514.00	\$538.00	\$561.00
A2000037	0.37	0.5	2810	71	9.3	0.9	14mm j6	\$591.00	\$620.00	\$646.00
A2000055	0.55	0.75	2800	71	11.2	1.23	14mm j6	\$591.00	\$620.00	\$646.00
A2000075	0.75	1	2795	80	11.2	1.53	19mm j6	\$770.00	\$806.00	\$839.00
A2000110	1.1	1.5	2820	80	11.9	2.26	19mm j6	\$840.00	\$881.00	\$916.00
A2000150	1.5	2	2860	90S	18.2	3.01	24mm j6	\$947.00	\$988.00	\$1,030.00
A2000220	2.2	3	2865	90L	19.4	4.39	24mm j6	\$1,063.00	\$1,114.00	\$1,159.00
A2000300	3	4	2895	100L	26.3	5.64	28mm j6	\$1,417.00	\$1,482.00	\$1,542.00
A2000400R	4	5.5	2895	100L	36.4	7.32	28mm j6	\$1,599.00		\$1,742.00
A2000400	4	5.5	2900	112M	34.1	7.45	28mm j6	\$1,652.00	\$1,728.00	\$1,803.00
A2000550R	5.5	7.5	2870	112M	46	10.1	28mm j6	\$2,019.00		\$2,204.00
A2000550	5.5	7.5	2935	132S	50.8	10.2	38mm k6	\$2,143.00	\$2,247.00	\$2,338.00
A2000750	7.5	10	2925	132S	58.2	13.69	38mm k6	\$2,407.00	\$2,522.00	\$2,624.00
A2001100R	11	15	2925	132M	72.3	20	38mm k6	\$3,835.00		\$4,179.00
A2001100	11	15	2950	160M	94.1	20.17	42mm k6	\$3,923.00	\$4,104.00	\$4,277.00
A2001500	15	20	2945	160M	101	27.13	42mm k6	\$4,278.00	\$4,474.00	\$4,663.00
A2001850	18.5	25	2945	160L	113	33.7	42mm k6	\$5,063.00	\$5,297.00	\$5,519.00
A2002200	22	30	2950	180M	145	38.83	48mm k6	\$6,320.00	\$6,613.00	\$6,888.00
A2003000	30	40	2960	200L	188	52.72	55mm m6	\$7,804.00		\$8,506.00
A2003700	37	50	2960	200L	197	64.9	55mm m6	POA	POA	POA



4 POLE

1500 RPM Three Phase IP55 TEFC, Multivoltage 380 - 415 Volt 50HZ

Frames 63-200 Aluminium, Frames 225-355 Cast Iron, Class "F" Insulation

11KW & Above Fitted With 1 x PTC Thermistor per Phase, 2 x PTC Thermistors per Phase 225 Frame & Above

160 Frame & Above Fitted with Grease Nipple & Grease Release Valve

Top Mount Terminal Box (Multi Mount ≤ 200 Frame)

PART NUMBER	KW	HP	RPM	FRAME	WEIGHT KG	FLC AMPS	SHAFT SIZE	TRADE PRICE		
								B3T FOOT	B14T or B5T FLANGE ONLY	B34T OR B35T FT & FLANGE
A4000012	0.12	0.16	1430	63	6.3	0.72	11mm j6	\$480.00	\$504.00	\$524.00
A4000018	0.18	0.25	1390	63	7.6	0.57	11mm j6	\$480.00	\$504.00	\$524.00
A4000025	0.25	0.33	1415	71	10.2	0.69	14mm j6	\$478.00	\$497.00	\$519.00
A4000037	0.37	0.5	1400	71	10.8	1.04	14mm j6	\$483.00	\$507.00	\$528.00
A4000055	0.55	0.75	1440	80	13.6	1.36	19mm j6	\$616.00	\$645.00	\$669.00
A4000070	0.7	1	1420	80	14	1.61	19mm j6	\$707.00	\$738.00	\$770.00
A4000110	1.1	1.5	1445	90S	19	2.37	24mm j6	\$864.00	\$904.00	\$939.00
A4000150	1.5	2	1450	90L	20.3	3.28	24mm j6	\$969.00	\$1,013.00	\$1,058.00
A4000220	2.2	3	1425	100L	32.8	4.42	28mm j6	\$1,188.00	\$1,245.00	\$1,297.00
A4000300	3	4	1430	100L	29.5	5.96	28mm j6	\$1,380.00	\$1,444.00	\$1,503.00
A4000400	4	5.5	1445	112M	35.3	7.85	28mm j6	\$1,720.00	\$1,799.00	\$1,874.00
A4000550	5.5	7.5	1465	132S	56.1	10.34	38mm k6	\$2,232.00	\$2,335.00	\$2,430.00
A4000750	7.5	10	1465	132M	63	13.89	38mm k6	\$2,632.00	\$2,756.00	\$2,871.00
A4000920	9.2	12.5	1465	132M	75	17.24	38mm k6	\$3,308.00		\$3,606.00
A4001100	11	15	1465	160M	107	20.84	42mm k6	\$3,716.00	\$3,889.00	\$4,050.00
A4001500	15	20	1465	160L	115	28.4	42mm k6	\$4,245.00		\$4,625.00
A4001850	18.5	25	1470	180M	139	34.83	48mm k6	\$5,767.00		\$6,287.00
A4002200	22	30	1475	180L	159	39.4	48mm k6	\$6,436.00		\$7,016.00
A4003000	30	40	1475	200L	198	55.6	55mm m6	\$8,002.00		\$8,721.00



6 POLE

1000 RPM Three Phase IP55 TEFC, Multivoltage 380 - 415 Volt 50HZ

Frames 63-200 Aluminium, Frames 225-355 Cast Iron, Class "F" Insulation

11KW & Above Fitted With 1 x PTC Thermistor per Phase, 2 x PTC Thermistors per Phase 225 Frame & Above

160 Frame & Above Fitted with Grease Nipple & Grease Release Valve

Top Mount Terminal Box (Multi Mount ≤ 200 Frame)

PART NUMBER	KW	HP	RPM	FRAME	WEIGHT KG	FLC AMPS	SHAFT SIZE	TRADE PRICE		
								B3T FOOT	B14T or B5T FLANGE ONLY	B34T OR B35T FT & FLANGE
A6000025	0.25	0.33	890	71	12.5	0.94	14mm j6	\$614.00		\$669.00
A6000037	0.37	0.5	925	80	14	1.3	19mm j6	\$699.00		\$762.00
A6000055	0.55	0.75	920	80	13.6	1.9	19mm j6	\$797.00		\$867.00
A6000075	0.75	1	920	90S	18.2	2.2	24mm j6	\$936.00		\$1,021.00
A6000110	1.1	1.5	920	90L	20.7	3	24mm j6	\$1,101.00		\$1,201.00
A6000150	1.5	2	945	100L	25.9	3.8	28mm j6	\$1,297.00		\$1,414.00
A6000220	2.2	3	950	112M	38.8	5.3	28mm j6	\$1,548.00		\$1,687.00
A6000300	3	4	960	132S	53	6.6	38mm k6	\$2,265.00		\$2,469.00
A6000400	4	5.5	960	132M	55.4	9	38mm k6	\$2,583.00		\$2,816.00
A6000550	5.5	7.5	965	132M	75	11	38mm k6	\$3,027.00		\$3,302.00
A6000750	7.5	10	970	160M	89.1	16	42mm k6	\$3,644.00		\$3,972.00
A6001100	11	15	970	160L	114	22	42mm k6	\$4,788.00		\$5,217.00
A6001500	15	20	970	180L	146	27	48mm k6	\$6,260.00		\$6,821.00



8 POLE

750 RPM Three Phase IP55 TEFC, Multivoltage 380 - 415 Volt 50HZ

Frames 63-200 Aluminium, Frames 225-355 Cast Iron, Class "F" Insulation

11KW & Above Fitted With 1 x PTC Thermistor per Phase, 2 x PTC Thermistors per Phase 225 Frame & Above

160 Frame & Above Fitted with Grease Nipple & Grease Release Valve

Top Mount Terminal Box (Multi Mount ≤ 200 Frame)

PART NUMBER	KW	HP	RPM	FRAME	WEIGHT KG	FLC AMPS	SHAFT SIZE	TRADE PRICE		
								B3T FOOT	B14T or B5T FLANGE ONLY	B34T OR B35T FT & FLANGE
A8000025	0.25	0.33	700	80	14.3	1	19mmj6	\$965.00		\$1,053.00
A8000037	0.37	0.5	690	90S	16	1.4	24mm j6	\$994.00		\$1,084.00
A8000055	0.55	0.75	690	90L	18.9	1.9	24mm j6	\$1,067.00		\$1,162.00
A8000075	0.75	1	710	100L	30.5	2.4	28mm j6	\$1,395.00		\$1,522.00
A8000110	1.1	1.5	700	100L	32	3.4	28mm j6	\$1,570.00		\$1,709.00
A8000150	1.5	2	710	112M	39	4	28mm j6	\$1,768.00		\$1,927.00
A8000220	2.2	3	710	132S	66	5.8	38mm k6	\$2,453.00		\$2,672.00
A8000300	3	4	710	132M	68	7.6	38mm k6	\$2,851.00		\$3,108.00
A8000400	4	5.5	725	160M	85.8	11	42mm k6	\$3,874.00		\$4,222.00
A8000550	5.5	7.5	730	160M	102	13	42mm k6	\$4,930.00		\$5,375.00
A8000750	7.5	10	725	160L	109	19	42mm k6	\$5,327.00		\$5,807.00
A8001100	11	15	725	180L	178	26	48mm k6	\$6,336.00		\$6,904.00
A8001500	15	20	730	200L	208	32	55mm m6	\$7,974.00		\$8,692.00

W21 CAST IRON TEFC

Lower-specced and cost effective electric motor.



Range 0.12kW to 330kW



2, 4, 6 and 8 Pole



MEPS Complaint



Electrical:

- Class "F" insulation
("B" Temperature Rise: 80 K)
- Ambient temperature: 40 °C 1000 at masl
- Voltages: 220-240/380-415 V - 50 Hz
(up to frame 100L) 380-415/660-690 V - 50 Hz
(frame 112M and above)//440-460 V - 60 Hz
- Service Factor (SF): 1.00
- Design: N
- Continuous duty: S1
- Terminal block (6 pins)
- Thermistors (1/phase) from frame
160 and above
- Dip and baked impregnation

Mechanical:

- Squirrel cage rotor (Aluminium die Cast)
- Enclosure: TEFC (Totally Enclosed Fan Cooled)
- Mounting: B3R(E)
- V'ring seals
- Ball Bearing (ZZ up to 132)
- Grease nipple system in frame 160 and above
- Shaft material: AISI 1040/45 steel
- Automatic drain plug
- Metric thread cable entries

W40 CAST IRON ODP

Used in dry dust free environments, these open frame motors can be made physically smaller and cost effective. Mainly used to drive compressors in refrigeration applications.



Range 11kW to 560kW



2 and 4 Pole



Low Vibration Levels



Low Noise Levels



MEPS Compliant



Electrical:

- Class "F" insulation ("B" Temperature Rise: 80 K) **Unless otherwise indicated**
- Ambient temperature: 40 °C at 1000 masl
- Voltages: 415 V - 50 Hz
- Service Factor (SF): 1.00
- Design: N
- Continuous duty: S1
- Terminal block (6 pins)
- Thermistors (1/phase) (frame 225S/M up to 280S/M)
- Dip and baked impregnation (frames 63 up to 200) Resin continuous flow impregnation (frame 225S/M up to 280S/M)

Mechanical:

- Squirrel cage rotor (Aluminium die Cast)
- Enclosure: ODP (Open drip proof)
- Mounting: B3R(E)
- Ball bearings
- Grease nipple system (225S/M and up)
- Shaft material: AISI 1040/45 steel
- Metric thread cable entries
- Single Grounding (160M up to 200L) Triple Grounding (225S/M and up)



2 POLE 3000 RPM Three Phase Cast Iron Frame IP23 Open Dripproof
 400 Volt 50HZ, Thermistors, Space Heaters, Class "H" Insulation
 Terminal Block, Grease Nipple & Grease Relief Valve

PART NUMBER	KW	RPM	FRAME	WEIGHT KG	FLC AMPS	SHAFT SIZE	TRADE PRICE	
							B3 FOOT	B35 FT&FLANGE
RW2011000RB3	110	2968	250S/M	456	183	65mm m6	POA	POA
RW2013200INEB3	132	2970	280S/M	603	229	65mm m6	POA	POA
RW2015000INEB3	150	2970	280S/M	627	263	65mm m6	POA	POA
RW2018500INEB3	185	2965	280S/M	850	314	65mm m6	POA	POA
RW2022000INEB3	220	2965	280S/M	860	373	65mm m6	POA	POA
RW2026000INEB3	260	2970	280S/M	860	446	65mm m6	POA	POA
RW2028000INEB3	280	2970	280S/M	860	474	65mm m6	POA	POA
RW2033000INEB3	330	2965	280L	1030	552	65mm m6	POA	POA
RW2035500INEB3	355	2970	280L	1030	600	65mm m6	POA	POA
RW2037000INEB3	370	2970	280L	1030	618	65mm m6	POA	POA
RW2045000INEB3	450	2980	315C/D	1670	778	65mm m6	POA	POA
RW2050000INEB3	500	2980	315C/D	1670	863	65mm m6	POA	POA
Z12006851	"A" FLANGE 280 WEG ODP MOTOR						POA	
Z12006853	"A" FLANGE 315 WEG ODP MOTOR						POA	
Z089-2-ODP	"A" FLANGE AGA315 WEG ODP MOTOR						POA	
Z12023020	Non-Drive Endshield Ins 280 2P ODP V'ring						POA	
Z12023023	Insulated Non-Drive Endshield 315 ODP V'ring						POA	

LARGER MOTORS ARE AVAILABLE ON REQUEST

W21 BRAKE CAST IRON TEFC

WEG Brake motors are fitted with an INTORQ brake. This brake is of sturdy construction with few moving parts, ensuring long durability with minimum maintenance.

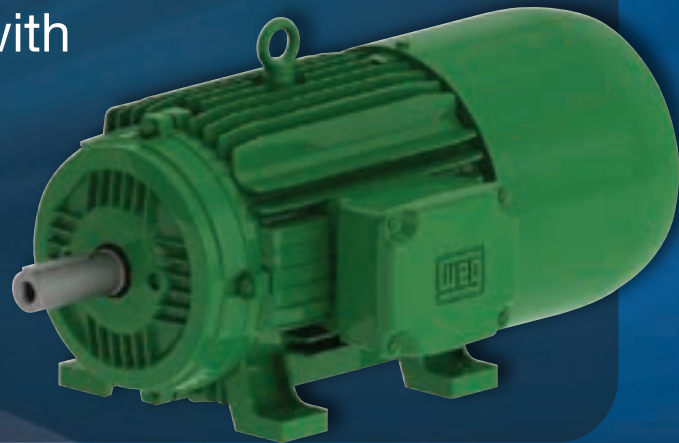

Range 0.12kW to 37kW



2, 4, 6 and 8 Pole



Supplied with INTORQ Brake



MEPS Compliant



Electrical:

- Class "F" insulation ("B" Temperature Rise: 80 K) **Unless otherwise indicated**
- Ambient temperature: 40 °C at 1000 masl
- Voltages: 220-240V/380-415 V - 50 Hz (up to frame 100L) 380-415/660-690 V - 50 Hz (frame 112M and above)//440-460 V - 60 Hz
- Service Factor (SF): 1.00
- Design: N
- Continuous duty: S1
- Terminal block (6 pins)
- Thermistors (1/phase) frame 160
- Dip and baked impregnation (frames 63 up to 160)

Mechanical:

- Squirrel cage rotor (Aluminium die Cast)
- Enclosure: TEFC (Totally Enclosed Fan Cooled)
- Mounting: B3R
- Ball bearings
- Shaft material: AISI 1040/45 steel
- Automatic drain plug
- Metric thread cable entries



4 POLE 1500 RPM BRAKE MOTOR THREE PHASE CAST IRON FRAME IP55 TEFC CLASS "F" INSULATION
 MULTIVOLTAGE 380 - 415 VOLT 50HZ 11KW & ABOVE FITTED WITH THERMISTORS
 160 FRAME & ABOVE FITTED WITH GREASE NIPPLE & GREASE RELIEF VALVE
 FRAME 71 - 112 COMPLETE WITH HAND RELEASE

PART NUMBER	KW	RPM	FRAME	WEIGHT KG	FLC AMPS	SHAFT SIZE	RATED TORQUE Nm	TRADE PRICE		
								B3 FOOT	B5 FLANGE ONLY	B34 OR B35 FT & FLANGE
B4000037	0.37	1405	71	10	1.14	14mm j6	8	\$2,008.00		\$2,190.00
B4000055	0.55	1420	80	14	1.52	19mm j6	8	\$2,232.00		\$2,430.00
B4000075	0.75	1420	80	18	1.85	19mm j6	8	\$2,571.00		\$2,804.00
B4000110	1.1	1385	90S	20	2.57	24mm j6	16	\$2,826.00		\$3,079.00
B4000150	1.5	1400	90L	25	3.3	24mm j6	16	\$3,306.00		\$3,602.00
B4000220	2.2	1415	100L	30	4.4	28mm j6	32	\$3,907.00		\$4,259.00
B4000300	3	1405	100L	34	6.2	28mm j6	32	\$4,551.00		\$4,960.00
B4000400	4	1440	112M	51	8.5	28mm j6	60	\$5,736.00		\$6,252.00
B4000550	5.5	1470	132S	63	10.8	38mm k6	125	\$6,363.00		\$6,937.00
B4000750	7.5	1465	132M	71	14.2	38mm k6	125	\$7,345.00		\$8,007.00
B4001100	11	1460	160M	116	20.7	42mm k6	235	\$10,799.00		\$11,770.00
B4001500	15	1460	160L	121	29.2	42mm k6	235	\$13,844.00		\$15,091.00

HAND RELEASE FOR 132 -160 POA

LARGER MOTORS ARE AVAILABLE ON REQUEST

W22 SPARES





Index

MOTOR EXPLODED VIEW

W22 - General Purpose

63 - 112	
132 - 200	
225 - 355	

FLANGES

W22 - General Purpose

FF Flange (Frames 63 to 132)	
FF Flange (Frames 160 to 200)	
FF Flange (Frames 225 to 355)	
FC-DIN Flange (Frames 63 to 132)	
FC-DIN Flange (Frames 160)	
"LARGER" FC-DIN Flange (Frames 71 to 100)	

BEARING RETAINER

W22 - General Purpose

Drive End Bearing Retainer (Frames 71 to 200)	
---	--

BEARING CAP

W22 - General Purpose

Bearing Cap (Frames 225 to 355)	
Bearing Cap with AEGIS Brush (Frames 280 to 355)	

DRIVE ENDSHIELD

W22 - General Purpose

Drive Endshield (Frames 63 to 132)	
Drive Endshield (Frames 160 to 200)	
Drive Endshield (Frames 225 to 355)	
Insulated Drive Endshield (Frames 225 to 355)	

NON DRIVE ENDSHIELD

W22 - General Purpose

Non Drive Endshield (Frames 63 to 132)	
Non Drive Endshield TEAO (Frame 63 to 132)	
Non Drive Endshield (Frames 160 to 200)	
Non Drive Endshield (Frames 225 to 355)	
Insulated Non Drive Endshield (Frames 225 to 355)	

FANS

W22 - General Purpose

Plastic Fan (Frames 63 to 355)	
--------------------------------------	--



Index

TERMINAL BOX

W22 - General Purpose

Terminal Box (Frames 63 - 355)	
Terminal Box Adaptor (Frames 225 - 355)	
Terminal Box Gasket (Lid) (Frames 63 - 355)	
Terminal Block (Frames 63 - 132)	
Terminal Block (Frames 160 - 355)	

OTHERS

W22 - General Purpose

Fan Covers (Frames 63 to 355)	
Rainhood (Frames 63 - 355)	
WEG WSeal® (Frames 225 - 355)	
Wavey Washer (Frames 63 to 200)	
Rubber Drain Plug (Frames 63 to 355)	
Shaft locking device (Frames 180 to 355)	

W22 Motor – Exploded View

63 - 112



Prices Exclude GST and are subject to change at any time Ref: V24

W22 Motor – Exploded View

132 - 200



Prices Exclude GST and are subject to change at any time Ref: V24



W22 Motor – Exploded View

225 - 355

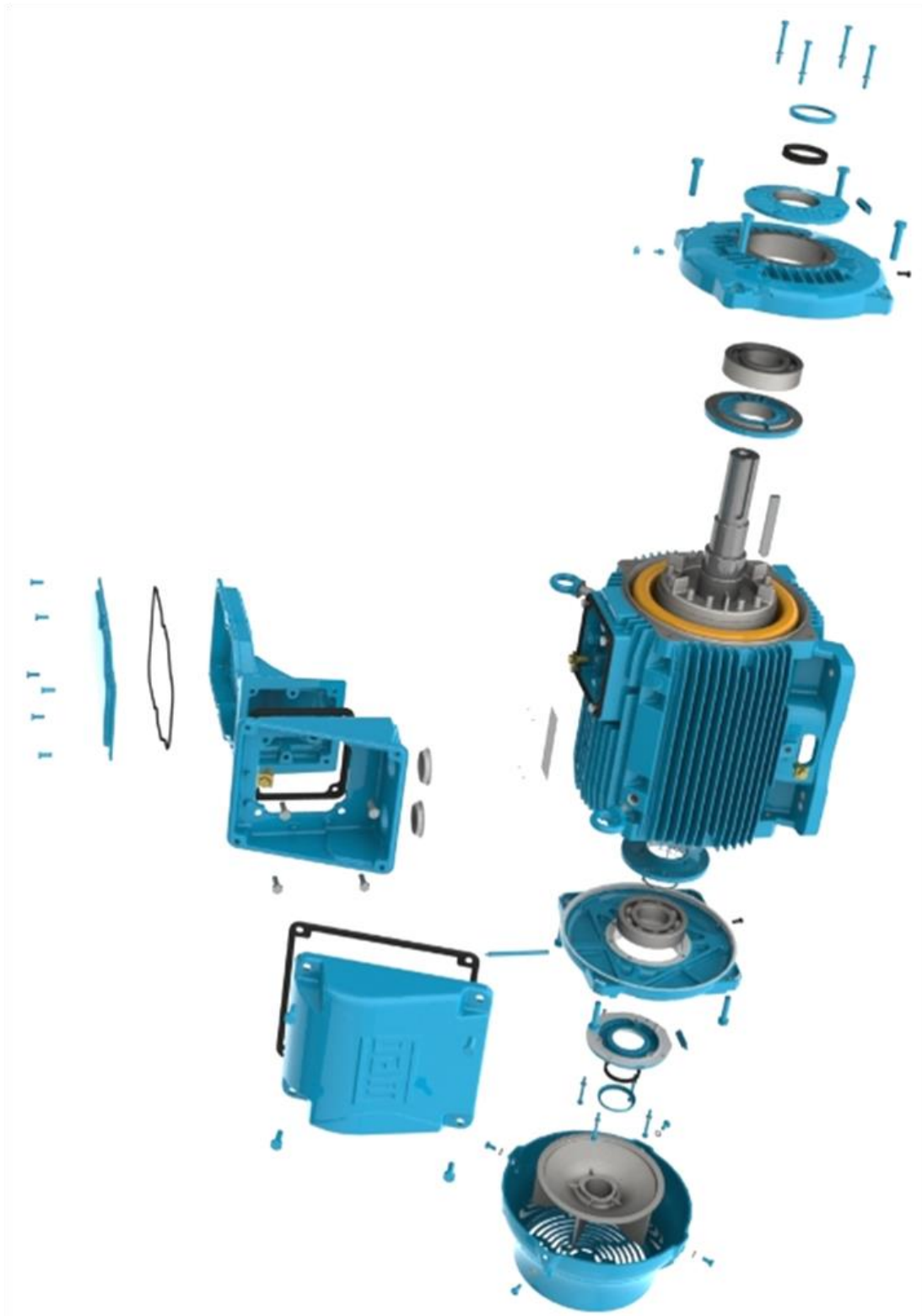

Prices Exclude GST and are subject to change at any time Ref: V24



FF Flange (Frames 63 to 132)

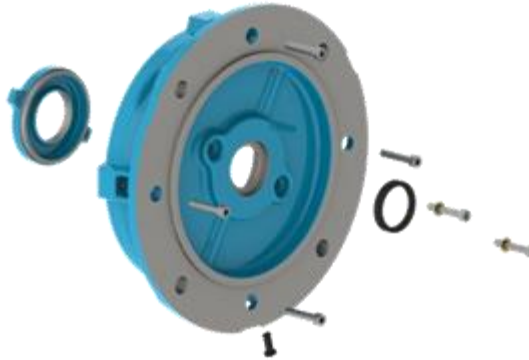

With Drain, With Bearing Cap and Without Grease Nipple

Kit Composition: Flange, Fixing Bolts, Internal Bearing Cap, Bolts and Washers for Bearing Cap Fixing, Drain and Oil Seal.

IEC Frame Size	Flange	Bearing	Part Number	TRADE Price NZ\$
63	FF-115	201	Z12284839	\$ 159
71	FF-130	202	Z12132949	\$ 173
80	FF-165	204	Z12284844	\$ 254
90		205	Z12284847	\$ 262
100	FF-215	206	Z12284904	\$ 365
112		207	Z12102602	\$ 387
132	FF-265	308	Z12285018	\$ 524



FF Flange (Frames 160 to 200)

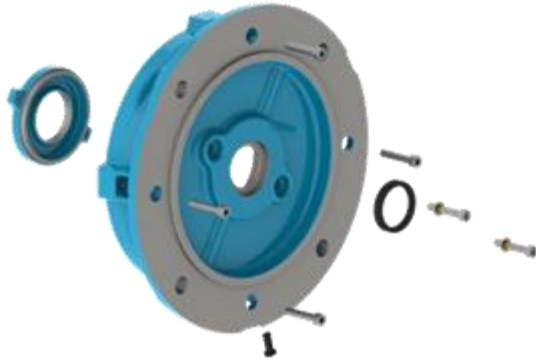

With Drain, With Bearing Cap, With Grease Nipple

Kit Composition: Flange, Fixing Bolts, Internal Bearing Cap, Bolts and Washers for Bearing Cap Fixing, Drain, Grease Nipple and Oil Seal.

IEC Frame Size	Flange	Bearing	Part Number	TRADE Price NZ\$
160	FF-300	309	Z12285873	\$ 1,086
180		311	Z10156995	\$ 1,086
200	FF-350	312	Z12285874	\$ 1,326



FF Flange (Frames 225 to 355)

With Drain, Without Bearing Cap, With Grease Nipple

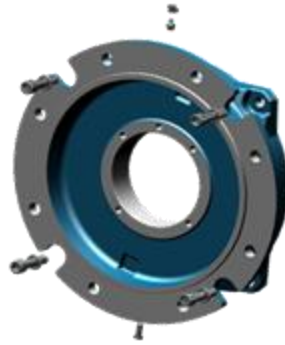

Kit Composition: Flange, Fixing Bolts, Drain, Grease Nipple.

IEC Frame Size	Flange	Bearing	Part Number	TRADE Price NZ\$
225	FF-400	314	Z11110159	\$ 2,095
250	FF-500	314	Z10792510	\$ 2,631
		316	Z10781000	\$ 2,631
280	FF-500	314	Z10223260	\$ 2,631
		319	Z10017531	\$ 2,631
315S/M	FF-600	314	Z11110233	\$ 3,519
		319	Z11110204	\$ 3,519
		322	Z13499026	\$ 3,395
355M/L	FF-740	316	Z12286780	\$ 4,529
		322	Z10824031	\$ 4,529



FC-DIN Flange (Frames 63 to 132)

With Drain, With Bearing Cap and Without Grease Nipple

Kit Composition: Flange, Fixing Bolts, Internal Bearing Cap, Bolts and Washers for Bearing Cap Fixing, Drain and Oil Seal.

IEC Frame Size	Flange	Bearing	Part Number	TRADE Price NZ\$
63	C-90	201	Z10017533	\$ 140
71	C-105	202	Z11508293	\$ 159
80	C-120	204	Z10156993	\$ 210
90	C-140	205	Z10156976	\$ 240
100	C-160	206	Z11543976	\$ 275
112		207	Z11508295	\$ 275
132	C-200	308	Z10796974	\$ 361



FC-DIN Flange (Frame 160)

With Drain, With Bearing Cap, With Grease Nipple

Kit Composition: Flange, Fixing Bolts, Internal Bearing Cap, Bolts and Washers for Bearing Cap Fixing, Drain, Grease Nipple and Oil Seal.

IEC Frame Size	Flange	Bearing	Part Number	TRADE Price NZ\$
160	C-250	309	Z12480863	\$ 1,006



"LARGER" FC-DIN Flange (Frames 71 to 100)

With Drain, With Bearing Cap and Without Grease Nipple

Kit Composition: Flange, Fixing Bolts, Internal Bearing Cap, Bolts and Washers for Bearing Cap Fixing, Drain and Oil Seal.

IEC Frame Size	Flange	Bearing	Part Number	TRADE Price NZ\$
71	C-140	202	Z11533455	\$ 203
80	C-160	204		
90		205	Z10157072	\$ 297
100	C-200	206		



Drive End Bearing Retainer (Frames 71 to 200)



Kit Composition: D.E. Bearing Retainer, bolts and washers.

Bearing (6 series)	Part Number	NET Price NZ\$
202	Z11703851	\$ 11
204	Z080B	\$ 11
205	Z090B	\$ 25
206	Z100B	\$ 25
207	Z11584302	\$ 25
308	Z132B	\$ 39
309	Z160B	\$ 56
311	Z180B	\$ 84
312	Z200B	\$ 119



Bearing Cap (Frames 225 to 355) - Wseal Sealing



Kit Composition: Internal Bearing Cap, External Bearing Cap, Wseal (Double Lip V`Ring, Metallic Cap), bolts, washers, grease relief.

Bearing (NU and 6 series)	Part Number	TRADE Price NZ\$
314 (5mm)	Z12160883	\$ 798
316 (5mm)	Z12160885	\$ 993
319 (5mm)	Z12160886	\$ 1,573
322 (5mm)	Z12160887	\$ 3,034
314 (2.5mm)	Z11099969	\$ 798
316 (2.5mm)	Z11099978	\$ 993
319 (2.5mm)	Z11099961	\$ 1,573



Bearing Cap (Frames 280 to 355) - Wseal Sealing + AEGIS Brush



Kit Composition: Internal Bearing Cap, External Bearing Cap, Wseal (Double Lip V`Ring, Metallic Cap), AEGIS brush, bolts, washers, grease relief.

Bearing (NU and 6 series)	Part Number	TRADE Price NZ\$
314 (5mm)	Z13554425	\$ 2,608
316 (5mm)	Z13554478	\$ 3,428
319 (5mm)	Z13554479	\$ 5,148
322 (5mm)	Z13554480	\$ 6,541



Drive Endshield (Frames 63 to 132)

With Drain, Without Bearing Cap and Without Grease Nipple



Kit Composition: Endshield, Fixing Bolts, Drain and Seal.

IEC Frame Size	Bearing	Seal	Part Number	NET Price NZ\$
63	201	Oil Seal	Z11334105	\$ 89
71	202	Oil Seal	Z11334134	\$ 96
80	204	Oil Seal	Z11334191	\$ 98
90	205	Oil Seal	Z11515689	\$ 101
100	206	Oil Seal	Z11515120	\$ 107
112	207	Oil Seal	Z11515121	\$ 113
132	208	Oil Seal	Z11334677	\$ 189



Drive Endshield (Frames 160 to 200)

With Drain, With Bearing Cap, With Grease Nipple



Kit Composition: Endshield, Fixing Bolts, Internal Bearing Cap, Bolts and Washers for Bearing Cap Fixing, Drain, Grease Nipple and Oil Seal.

IEC Frame Size	Bearing	Seal	Part Number	NET Price NZ\$
160	309	Oil Seal	Z11728966	\$ 365
180	311	Oil Seal	Z11279647	\$ 530
200	312	Oil Seal	Z11279849	\$ 773



Drive Endshield (Frames 225 to 355)

With Drain, Without Bearing Cap, With Grease Nipple



Kit Composition: Endshield, Drain, Grease Nipple, Bolts, Washers.

IEC Frame Size	Bearing	Pole	Part Number	NET Price NZ\$
225	314	2/4/6/8	Z11110373	\$ 534
250	314	2	Z11110358	\$ 630
	316	4/6/8	Z11110307	\$ 630
280	314	2	Z11110367	\$ 1,321
	319	4/6/8	Z11110306	\$ 1,321
315S/M	314	2	Z11110447	\$ 1,321
	319	4/6/8	Z11110461	\$ 1,321
355M/L	316	2	Z11110490	\$ 3,115
	322	4/6/8	Z11110494	\$ 3,115



Insulated Drive Endshield (Frames 280 to 355)

With Drain, Without Bearing Cap, With Grease Nipple



Kit Composition: Insulated Endshield, Drain Plug, Grease Nipple, Bolts, Washers.

IEC Frame Size	Bearing	Pole	Part Number	NET Price NZ\$
280	314	2	Z11497144	\$ 3,654
	319	4/6/8	Z11553388	\$ 3,654
315S/M	314	2	Z11498064	\$ 3,654
	319	4/6/8	Z11498070	\$ 3,654
355M/L	316	2	Z11554355	\$ 5,552
	322	4/6/8	Z11498073	\$ 5,552

* As Standard, the NDE endshield is the preferred Insulated Endshield



Non-Drive Endshield (Frames 63 to 132)

With Drain, Without Bearing Cap and Without Grease Nipple

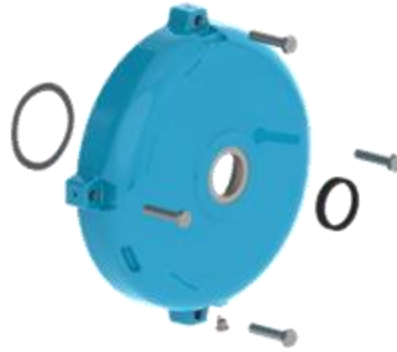

Kit Composition: Endshield, Fixing Bolts, Drain, Spring Washer and Oil Seal.

IEC Frame Size	Bearing	Seal	Part Number	NET Price NZ\$
63	6201	Oil Seal	Z11335768	\$ 38
71	6202	Oil Seal	Z11335807	\$ 45
80	6203	Oil Seal	Z11335902	\$ 49
L80	6203	Oil Seal	Z11165807	\$ 171
90	6204	Oil Seal	Z11503374	\$ 52
L90	6204	Oil Seal	Z11503452	\$ 183
100	6205	Oil Seal	Z11503375	\$ 77
L100	6205	Oil Seal	Z11503453	\$ 387
112	6206	Oil Seal	Z11503538	\$ 94
132	6207	Oil Seal	Z11336655	\$ 176



TEAO Non-Drive Endshield (Frames 63 to 132)

With Drain, Without Bearing Cap and Without Grease Nipple

Kit Composition: Endshield, Fixing Bolts, Drain, Spring Washer and Oil Seal.

IEC Frame Size	Bearing	Seal	Part Number	NET Price NZ\$
63	6201	N/A	-	\$ 70
71	6202	N/A	Z11335833	\$ 82
80	6203	N/A	Z11335908	\$ 82
L80	6203	N/A	-	\$ 185
90	6204	N/A	Z11336248	\$ 88
L90	6204	N/A	Z12884893	\$ 198
100	6205	N/A	Z11336506	\$ 108
L100	6205	N/A	Z12896148	\$ 417
112	6206	N/A	Z11336633	\$ 118
132	6207	N/A	Z11041462	\$ 189



Non-Drive Endshield (Frames 160 to 200)

With Drain, With Bearing Cap, With Grease Nipple

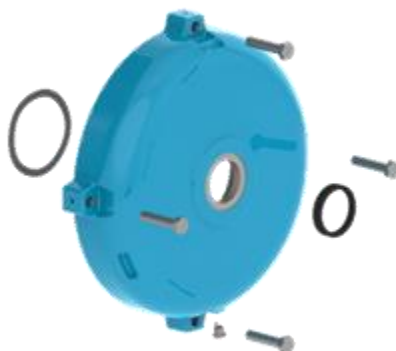

Kit Composition: Endshield, Fixing Bolts, Internal Bearing Cap, Bolts and Washers for Bearing Cap Fixing, Drain, Grease Nipple, Spring Washer and Oil Seal.

IEC Frame Size	Bearing	Seal	Part Number	NET Price NZ\$
160	6209	Oil Seal	Z11503618	\$ 350
180	6211	Oil Seal	Z11280151	\$ 509
200	6212	Oil Seal	Z11280185	\$ 746



Non-Drive Endshield (Frames 225 to 355)

With Drain, Without Bearing Cap, With Grease Nipple



Kit Composition: Endshield, Drain Plug, Grease Nipple, Bolts, Washers.

IEC Frame Size	Bearing	Pole	Part Number	NET Price NZ\$
225	314	2/4/6/8	Z11110375	\$ 647
250	314	2/4/6/8	Z11110376	\$ 647
280	314	2	Z11110441	\$ 1,321
	316	4/6/8	Z11110443	\$ 1,321
315S/M	314	2	Z11110463	\$ 1,321
	316	4/6/8	Z11110465	\$ 1,321
355M/L	314	2	Z11110496	\$ 3,115
	319	4/6/8	Z11110520	\$ 3,115



Insulated Non-Drive Endshield (Frames 280 to 355)

With Drain, Without Bearing Cap, With Grease Nipple



Kit Composition: Insulated Endshield, Drain Plug, Grease Nipple, Bolts, Washers.

IEC Frame Size	Bearing	Pole	Part Number	NET Price NZ\$
280	314	2	Z11203166	\$ 3,633
	316	4/6/8	Z11203189	\$ 3,633
315S/M	314	2	Z11203251	\$ 3,633
	316	4/6/8	Z11203250	\$ 3,633
355M/L	314	2	Z11203293	\$ 5,520
	319	4/6/8	Z11203295	\$ 5,520

* As Standard, the NDE endshield is the preferred Insulated Endshield



Plastic Fan (Frames 63 to 355)



Kit Composition: Fan (+circlip).

IEC Frame Size	Pole	Part Number	NET Price NZ\$
63	All	Z046	\$ 31
71	All	Z047	\$ 36
80	2	Z047	\$ 36
	4/6/8	Z048	\$ 39
90	2/4	Z048	\$ 39
	6/8	Z049	\$ 40
100	All	Z050	\$ 41
112	2/4	Z051-2	\$ 43
	6/8	Z051	\$ 43
132	2/4	Z051-2	\$ 43
	6/8	Z052	\$ 48
160	2/4	Z053-2	\$ 64
	6/8	Z053	\$ 64
180	2/4	Z054-2	\$ 96
	6/8	Z054	\$ 96
200	2/4	Z055-2	\$ 139
	6/8	Z055	\$ 139
225	2	Z11482640	\$ 249
	4	Z11482641	\$ 249
	6/8	Z11482642	\$ 249
250	2	Z11482640	\$ 249
	4	Z11482679	\$ 249
	6/8	Z11482642	\$ 249
280	2	Z11482641	\$ 249
	4	Z11482642	\$ 249
	6/8	Z11482643	\$ 392
315	2	Z11482641	\$ 249
	4	Z11482642	\$ 249
	6/8	Z11482643	\$ 392
355	2	Z11482679	\$ 249
	4	Z11482643	\$ 392
	6/8	N/A	N/A

Prices Exclude GST and are subject to change at any time Ref: V24



Terminal Box



Kit Composition: Terminal Box, Fixing Bolts, Rubber Gasket, T-Box Cover, Cover Fixing Bolts and Seal (Gasket).

IEC Frame Size	Holes	Part Number	NET Price NZ\$
63 / 71 / 80 / 90 / 100	M20X1,5	Z11494468	\$ 98
112 / 132	M25X1,5	Z11494529	\$ 178
160	2x M32x1,5 (+M20)	Z11494605	\$ 189
180	2x M40x1,5 (+M20)	Z11233474	\$ 189
200	2 x M50x1,5 (+M40)	Z11233424	\$ 276
225 / 250	2 x M63x1,5 (+M40)	Z11202932	\$ 414
280		Z11202933	\$ 653
315S/M		Z11202935	\$ 1,261
315L / 355		Z11510824	\$ 2,207
		Z12046153*	\$ 404
355A/B		T.B.A.	T.B.A.

* Gland plate to be sold together with the Terminal Box.



Terminal Box Adaptor



Kit Composition: Terminal Box Adaptor, Fixing Bolts, Rubber Gasket, Adaptor Cover, Cover Fixing Bolts and Seal (Gasket).

IEC Frame Size	Part Number	NET Price NZ\$
225 / 250	Z11202961	\$ 719
280	Z11202980	\$ 846
315S/M	Z11202981	\$ 998
355	Z11202987	\$ 1,386



Terminal Box Gasket (Lid)



Kit Composition: Rubber Gasket.

IEC Frame Size	Part Number	NET Price NZ\$
63 / 71 / 80	Z10934792	\$ 27
90 / 100	Z10934830	\$ 27
112 / 132	Z10934831	\$ 27
160/180	Z11179451	\$ 27
200	Z11179488	\$ 27
225 / 250	Z10688523	\$ 32
280	Z10721283	\$ 39
315S/M	Z10721364	\$ 48
355	Z10707273	\$ 48



Terminal Block (Frames 63 - 132)

Kit Composition: Terminal block, fixing bolts, connection strips and nuts.

IEC Frame Size	Part Number	NET Price NZ\$
63	Z001A	\$ 43
71		
80		
90		
100		
112	Z003A	\$ 61
132		



Terminal Block (Frames 160 - 355)

Kit Composition: Terminal block, fixing base, fixing bolts, connection strips and nuts.

IEC Frame Size	Part Number	NET Price NZ\$
160	Z004A	\$ 108
180		
200	Z005A	\$ 184
225	Z006A	\$ 330
250		
280	Z007A	\$ 767
315S/M	Z11210070	\$ 767
355M/L	Z008A	\$ 1,719



Fan Covers (Frames 63 to 355)



Kit Composition: Fan Cover, Fixing Bolts and Washer (only for 160 - 355).

IEC Frame Size	Part Number	NET Price NZ\$
63	Z061	\$ 39
71	Z062	\$ 40
80	Z063	\$ 41
90	Z064	\$ 43
100	Z065	\$ 48
112	Z066	\$ 51
132	Z067	\$ 66
160	Z11329037	\$ 131
180	Z11247535	\$ 212
200	Z11247572	\$ 276
225	Z11103674	\$ 578
250	Z11103682	\$ 754
280	Z11103686	\$ 1,154
315	Z11103700	\$ 1,595
355	Z11103704	\$ 2,648



Rainhood (Frames 63 to 355)

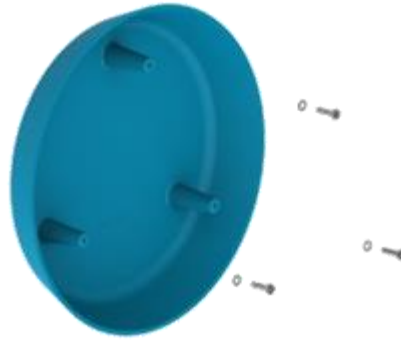

Kit Composition: Canopy (Drip Cover), Bolts, Washers and Spacers

IEC Frame Size	Part Number	NET Price NZ\$
63	Z061RHK	\$ 92
71	Z062RHK	\$ 93
80	Z063RHK	\$ 97
90	Z064RHK	\$ 118
100	Z065RHK	\$ 150
112	Z066RHK	\$ 196
132	Z067RHK	\$ 266
160	Z11474771	\$ 335
180	Z11474729	\$ 446
200	Z11474730	\$ 599
225	Z11474733	\$ 806
250	Z11474735	\$ 1,091
280	Z11474736	\$ 1,474
315	Z11474768	\$ 2,001
355	Z11474769	\$ 2,716



WEG WSeal® (Frames 225 to 355)

With Double Seal V'Ring and Metal Cap



Bearing	Double Lip V'Ring Part Number	NET Price NZ\$	Metal Cap Part Number	NET Price NZ\$
314	Z10772671	\$ 30	Z10772752	\$ 25
316	Z10798328	\$ 32	Z10798319	\$ 27
319	Z10798364	\$ 40	Z10798318	\$ 28
322	Z10798367	\$ 48	Z10798378	\$ 32



Wavey Washer (Frames 63 to 200)



Kit Composition: Wavey washer

Frame	⌀ Diameter	Part Number	NET Price NZ\$
63	32mm	WW0063	\$ 15
71	35mm	WW0071	\$ 16
80	40mm	WW0080	\$ 17
90	47mm	WW0090	\$ 23
100	52mm	WW0100	\$ 24
112	62mm	WW0112	\$ 27
132	72mm	WW0132	\$ 30
160	85mm	WW0160	\$ 31
180	100mm	WW0180	\$ 36
200	110mm	WW0200	\$ 39



Rubber Drain Plug (Frames 63 to 355)

Kit Composition: Rubber drain plug

Frame	Part Number	NET Price NZ\$
63	Z11394267	\$ 32
71		
80		
90		
100		
112		
132		
160	Z10652832	\$ 36
180		
200		
225		
250		
280		
315		
355		



OTHERS

Part Number	Product Description	NET Price NZ\$
Z12181985	Terminal Box 63-100 DIP (ATEX) Weg Electric Motor	\$ 124
Z12104884	Terminal Box 63-100 (Right) Ex nA/Ex tD (IECEX) W22 WEG Electric Motor	\$ 229
Z12104856	Terminal Box 63-100 (Left) Ex nA/Ex tD (IECEX) W22 WEG Electric Motor	\$ 229
Z10016993	Grounding Lug 63 - 100 W22 WEG Electric Motor	\$ 48
Z10016994	Grounding Lug 112 - 132 W22 WEG Electric Motor	\$ 69
Z10016995	Grounding Lug 160 - 180 W22 WEG Electric Motor	\$ 116
Z10016996	Grounding Lug 200 W22 WEG Electric Motor	\$ 182
Z11298837	Nameplate for 155°C Thermistor Set	\$ 59
Z11842299	Nameplate Warning Label for Ex-n and DIP WEG Motor	\$ 2



CONDUCTIVE PLASTIC FAN

Part Number	Product Description	NET Price NZ\$
Z11864561	FAN BLADE 63 CONDUCTIVE PLASTIC	\$ 43
Z11864562	FAN BLADE 71/80 2P CONDUCTIVE PLASTIC	\$ 46
Z11526945	FAN BLADE 80 4-6-8P/90 2-4P CONDUCTIVE PLASTIC	\$ 52
Z10876069	FAN BLADE 90 6-8P/100 2-4P CONDUCTIVE PLASTIC	\$ 55
Z10876070	FAN BLADE 100 6-8P CONDUCTIVE PLASTIC	\$ 56
Z11273769	FAN BLADE 112 2-4P/132 2-4P CONDUCTIVE PLASTIC	\$ 57
Z10876072	FAN BLADE 112 6-8P CONDUCTIVE PLASTIC	\$ 57
Z11333937	FAN BLADE 132 6-8P CONDUCTIVE PLASTIC	\$ 64
Z10864296	FAN BLADE 160 2-4P CONDUCTIVE PLASTIC	\$ 88
Z11388530	FAN BLADE 160 6-8P CONDUCTIVE PLASTIC	\$ 88
Z11458011	FAN BLADE 180 2-4P CONDUCTIVE PLASTIC	\$ 131
Z10864318	FAN BLADE 180 6-8P CONDUCTIVE PLASTIC	\$ 131
Z10864293	FAN BLADE 200 2-4P CONDUCTIVE PLASTIC	\$ 188
Z11038268	FAN BLADE 200 6-8P CONDUCTIVE PLASTIC	\$ 188
Z11268265	FAN BLADE 225 2P CONDUCTIVE PLASTIC	\$ 171
Z11360888	FAN BLADE 225 4P CONDUCTIVE PLASTIC	\$ 425
Z10864370	FAN BLADE 225 6-8P CONDUCTIVE PLASTIC	\$ 425



FORCED COOLING KIT

Part Number	Product Description	NET Price NZ\$
Z10802409	Forced Cooled F/Cover 90 W22 Weg Electric Motor	\$ 1,607
Z10694172	Forced Cooled F/Cover 100 W22 Weg Electric Motor	\$ 1,961
Z11659152	Forced Cooled F/Cover 112 W22 Weg Electric Motor	\$ 2,051
Z10797046	Forced Cooled F/Cover 132 W22 Weg Electric Motor	\$ 2,211
Z11659217	Forced Cooled F/Cover 160 W22 Weg Electric Motor	\$ 2,428
Z13789127	Non-Drive Endshield 160 W22 Oil Seal for Forced Colling Kit	\$ 351
Z10083011	Forced Cooled F/Cover 180 W22 Weg Electric Motor	\$ 2,583
Z13789258	Non-Drive Endshield 180 W22 Oil Seal for Forced Colling Kit	\$ 456
Z10017537	Forced Cooled F/Cover 200 W22 Weg Electric Motor	\$ 2,837
Z13789259	Non-Drive Endshield 200 W22 Oil Seal for Forced Colling Kit	\$ 748
Z11659240	Forced Cooled F/Cover 225 W22 Weg Electric Motor	\$ 3,173
Z11659374	Forced Cooled F/Cover 250 W22 Weg Electric Motor	\$ 3,173
Z11659375	Forced Cooled F/Cover 280 W22 Weg Electric Motor	\$ 3,920
Z11659390	Forced Cooled F/Cover 315 W22 Weg Electric Motor	\$ 3,920

W22 FCK frame sizes 160, 225 and 315 are not interchangeable with W21

W22 FCK frame sizes 160, 225 and 315 require a special N.D.E. Endshield



SHAFT LOCKING DEVICE

Part Number	Product Description	NET Price NZ\$
Z12723357	Shaft locking device 180 4P Weg Electric Motor	\$ 163
Z12723395	Shaft locking device 200 4P Weg Electric Motor	\$ 204
Z11041727	Shaft locking device 225 4P Weg Electric Motor	\$ 226
Z12723418	Shaft locking device 250 4P Weg Electric Motor	\$ 233
Z10142762	Shaft locking device 280 4P Weg Electric Motor	\$ 237
Z11784750	Shaft locking device 315 4P Weg Electric Motor	\$ 240
Z11916751	Shaft locking device 355 4P Weg Electric Motor	\$ 245

W21 SPARES





THREE PHASE IP55 CAST IRON FRAME

PART NUMBER	DESCRIPTION	FRAME	TRADE PRICE
Z077	FLANGE TYPE "A"	71	\$118.00
Z081	FLANGE TYPE "A"	112	\$185.00
Z083G	FLANGE TYPE "A"	160	\$466.00
Z086	FLANGE TYPE "A"	225	\$962.00
Z089	FLANGE TYPE "A" (6319)	315	\$1,488.00
Z089B	FLANGE TYPE "A" (6322)	315 Barnac	\$1,488.00
Z089-2	FLANGE TYPE "A" 2 POLE (6314)	315 2P	\$1,488.00



THREE PHASE IP55 CAST IRON FRAME

PART NUMBER	DESCRIPTION	FRAME	TRADE PRICE
Z314DEV	BEARING CAP KIT (5mm) - V-Ring - 6314	225 4P/225/250/280/315 2P	\$288.00
Z314DE	BEARING CAP KIT (5mm) - Oil Seal - 6314	225 4P/225/250/280/315 2P	\$288.00
Z314DELAB	BEARING CAP KIT (5mm) - LAB - 6314	225 4P/225/250/280/315 2P	\$718.00
Z314DEW3	BEARING CAP KIT (5mm) - W3 - 6314	225 4P/225/250/280/315 2P	\$5,448.00
Z316DEV	BEARING CAP KIT (5mm) - V-Ring - 6316	250 4P/355 2P	\$288.00
Z316DE	BEARING CAP KIT (5mm) - Oil Seal - 6316	250 4P/355 2P	\$288.00
Z316DELAB	BEARING CAP KIT (5mm) - LAB - 6316	250 4P/355 2P	\$891.00
Z316DEW3	BEARING CAP KIT (5mm) - W3 - 6316	250 4P/355 2P	\$5,448.00
Z319DEV	BEARING CAP KIT (5mm) - V-Ring - 6319	280/315 4P	\$471.00
Z319DELAB	BEARING CAP KIT (5mm) - LAB - 6319	280/315 4P	\$1,412.00
Z319DEW3	BEARING CAP KIT (5mm) - W3 - 6319	280/315 4P	\$6,335.00
Z322DEV	BEARING CAP KIT (5mm) - V-Ring - 6322	355 4P	\$910.00
Z322DELAB	BEARING CAP KIT (5mm) - LAB - 6322	355 4P	\$2,724.00
Z322DEW3	BEARING CAP KIT (5mm) - W3 - 6322	355 4P	\$7,600.00
Z314NDEV	BEARING CAP KIT (2.5mm) - V-Ring - 6314	225/250 2/4P/280/315/355 2P	\$288.00
Z314NDE	BEARING CAP KIT (2.5mm) - Lip Seal - 6314	225 2/4P/250/280/315/355 2P	\$288.00
Z314NDELAB	BEARING CAP KIT (2.5mm) - LAB - 6314	225/250 2/4P/280/315/355 2P	\$718.00
Z314NDEW3	BEARING CAP KIT (2.5mm) - W3 - 6314	225/250 2/4P/280/315/355 2P	\$5,448.00
Z316NDEV	BEARING CAP KIT (2.5mm) - V-Ring - 6316	280/315 4P	\$250.00
Z316NDELAB	BEARING CAP KIT (2.5mm) - LAB - 6316	280/315 4P	\$891.00
Z316NDEW3	BEARING CAP KIT (2.5mm) - W3 - 6316	280/315 4P	\$6,335.00
Z319NDEV	BEARING CAP KIT (2.5mm) - V-Ring - 6319	355 4P	\$471.00
Z319NDELAB	BEARING CAP KIT (2.5mm) - LAB - 6319	355 4P	\$1,412.00
Z319NDEW3	BEARING CAP KIT (2.5mm) - W3 - 6319	355 4P	\$7,600.00
Z077C	FLANGE TYPE "C" METRIC	71	\$118.00
Z081C	FLANGE TYPE "C" METRIC	112	\$185.00
Z083C	FLANGE TYPE "C" METRIC	160	\$466.00



THREE PHASE IP55 CAST IRON FRAME

PART NUMBER	DESCRIPTION	FRAME	NET PRICE
Z007A	TERMINAL BLOCK - KM12	280/315	\$767.00
Z007	TERMINAL BOX	200	\$276.00
Z008	TERMINAL BOX	225/250	\$414.00
Z009	TERMINAL BOX	280	\$653.00
Z010	TERMINAL BOX	315	\$1,261.00
Z011	TERMINAL BOX	355	\$2,207.00
Z001GF	GASKET - Terminal Box to Frame	63/71/80/100	\$27.00
Z005GF	GASKET - Terminal Box to Frame	112/132	\$27.00
Z006GF	GASKET - Terminal Box to Frame	160/180	\$27.00
Z007GF	GASKET - Terminal Box to Frame	200	\$27.00
Z008GF	GASKET - Terminal Box to Frame	225/250	\$32.00
Z009GF	GASKET - Terminal Box to Frame	280	\$39.00
Z010GF	GASKET - Terminal Box to Frame	315	\$48.00
Z011GF	GASKET - Terminal Box to Frame	355	\$48.00
Z001GB	GASKET - Terminal Box Lid	63/71/80	\$27.00
Z003GB	GASKET - Terminal Box Lid	90/100	\$27.00
Z005GB	GASKET - Terminal Box Lid	112/132	\$27.00
Z006GB	GASKET - Terminal Box Lid	160/180	\$27.00
Z007GB	GASKET - Terminal Box Lid	200	\$27.00
Z008GB	GASKET - Terminal Box Lid	225/250	\$32.00
Z009GB	GASKET - Terminal Box Lid	280	\$39.00
Z010GB	GASKET - Terminal Box Lid	315	\$48.00
Z011GB	GASKET - Terminal Box Lid	355	\$48.00



THREE PHASE IP55 CAST IRON FRAME

PART NUMBER	DESCRIPTION	FRAME	NET PRICE
Z017	DRIVE ENDSHIELD - OIL SEAL	71	\$96.00
Z017V	DRIVE ENDSHIELD - VRING SEAL	71	\$40.00
Z021	DRIVE ENDSHIELD - OIL SEAL	112	\$113.00
Z021V	DRIVE ENDSHIELD - VRING SEAL	112	\$71.00
Z023G	DRIVE ENDSHIELD - OIL SEAL	160	\$365.00
Z023GV	DRIVE ENDSHIELD - VRING SEAL	160	\$239.00
Z024G	DRIVE ENDSHIELD - OIL SEAL	180	\$530.00
Z024GV	DRIVE ENDSHIELD - VRING SEAL	180	\$348.00
Z025G	DRIVE ENDSHIELD - OIL SEAL	200	\$773.00
Z025GV	DRIVE ENDSHIELD - VRING SEAL	200	\$507.00
Z026	DRIVE ENDSHIELD	225 2/4P/250 2P	\$449.00
Z027	DRIVE ENDSHIELD	250 4P	\$449.00
Z028-2	DRIVE ENDSHIELD	280 2P	\$1,321.00
Z028-2INS	DRIVE ENDSHIELD - Insulated	280 2P	\$3,940.00
Z029	DRIVE ENDSHIELD	280/315 4P	\$1,321.00
Z029INS	DRIVE ENDSHIELD - Insulated	280/315 4P	\$3,940.00
Z029BINS	DRIVE ENDSHIELD - Insulated	315 4P (NU322)	\$3,940.00
Z029-2	DRIVE ENDSHIELD	315 2P	\$1,321.00
Z029-2INS	DRIVE ENDSHIELD - Insulated	315 2P	\$3,940.00
Z030	DRIVE ENDSHIELD	355	\$3,115.00
Z030INS	DRIVE ENDSHIELD - Insulated	355	\$5,985.00
Z030-2	DRIVE ENDSHIELD	355 2P	\$3,115.00
Z030-2INS	DRIVE ENDSHIELD - Insulated	355 2P	\$5,985.00



THREE PHASE IP55 CAST IRON FRAME+A137:D185

PART NUMBER	DESCRIPTION	FRAME	NET PRICE
Z016A	DRIVE END OIL SEAL 28 X 12 X 7	63	\$17.00
Z017A	DRIVE END OIL SEAL 28 X 17 X 5	71	\$17.00
Z018A	DRIVE END OIL SEAL 32 X 20 X 7	80	\$19.00
Z019A	DRIVE END OIL SEAL 35 X 25 X 7	90	\$24.00
Z020A	DRIVE END OIL SEAL 37 X 30 X 4	100	\$28.00
Z021A	DRIVE END OIL SEAL 45 X 35 X 7	112	\$31.00
Z022A	DRIVE END OIL SEAL 56 X 40 X 8	132	\$40.00
Z023A	DRIVE END OIL SEAL 62 X 45 X 7	160	\$43.00
Z024A	DRIVE END OIL SEAL 70 X 55 X 8	180	\$63.00
Z025A	DRIVE END OIL SEAL 75 X 60 X 8	200	\$93.00
Z026A	DRIVE END OIL SEAL 85 X 70 X 8	225 2/4P, 250/280/315 2P	\$99.00
Z028A	DRIVE END OIL SEAL 100 X 80 X 10	250 4P	\$121.00
Z016T	DRIVE END SLINGER	63	\$11.00
Z017T	DRIVE END SLINGER	71	\$13.00
Z018T	DRIVE END SLINGER	80	\$13.00
Z019T	DRIVE END SLINGER	90	\$13.00
Z020T	DRIVE END SLINGER	100	\$15.00
Z021T	DRIVE END SLINGER	112	\$17.00
Z022T	DRIVE END SLINGER	132	\$23.00
Z023T	DRIVE END SLINGER	160	\$32.00
Z024T	DRIVE END SLINGER	180	\$40.00
Z025T	DRIVE END SLINGER	200	\$45.00
Z026T	DRIVE END SLINGER	225 2P	\$48.00
Z027T	DRIVE END SLINGER	225 4P/250 2P	\$48.00
Z028T	DRIVE END SLINGER	250 4P/280 315 2P	\$51.00
Z029T	DRIVE END SLINGER	280 4P	\$53.00
Z030T	DRIVE END SLINGER	315 4P	\$56.00
Z031	NON-DRIVE ENDSHIELD - OIL SEAL	63	\$41.00
Z031V	NON-DRIVE ENDSHIELD - VRING SEAL	63	\$31.00
Z032	NON-DRIVE ENDSHIELD - OIL SEAL	71	\$48.00
Z032V	NON-DRIVE ENDSHIELD - VRING SEAL	71	\$40.00
Z033	NON-DRIVE ENDSHIELD - OIL SEAL	80	\$53.00
Z033S	NON-DRIVE ENDSHIELD - OIL SEAL	80 - T4000075B3	\$185.00
Z033V	NON-DRIVE ENDSHIELD - VRING SEAL	80	\$43.00
Z034	NON-DRIVE ENDSHIELD - OIL SEAL	90	\$56.00
Z034V	NON-DRIVE ENDSHIELD - VRING SEAL	90	\$40.00
Z034W3	NON-DRIVE ENDSHIELD - W3	90	\$1,564.00
Z035	NON-DRIVE ENDSHIELD - OIL SEAL	100	\$84.00
Z035S	NON-DRIVE ENDSHIELD - OIL SEAL	100 - T4000300B3	\$417.00
Z035V	NON-DRIVE ENDSHIELD - VRING SEAL	100	\$56.00
Z035VS	NON-DRIVE ENDSHIELD - VRING SEAL	100 - T4000300B3	\$417.00
Z035W3	NON-DRIVE ENDSHIELD - W3	100	\$1,688.00
Z036	NON-DRIVE ENDSHIELD - OIL SEAL	112	\$101.00
Z036V	NON-DRIVE ENDSHIELD - VRING SEAL	112	\$71.00
Z036W3	NON-DRIVE ENDSHIELD - W3	112	\$1,805.00



THREE PHASE IP55 A196:D255CAST IRON FRAME

PART NUMBER	DESCRIPTION	FRAME	NET PRICE
Z037	NON-DRIVE ENDSHIELD - OIL SEAL	132	\$189.00
Z037V	NON-DRIVE ENDSHIELD - VRING SEAL	132	\$134.00
Z037W3	NON-DRIVE ENDSHIELD - W3	132	\$1,922.00
Z038G	NON-DRIVE ENDSHIELD - OIL SEAL	160	\$350.00
Z038GV	NON-DRIVE ENDSHIELD - VRING SEAL	160	\$320.00
Z038GLAB	NON-DRIVE ENDSHIELD - LABYRINTH SEAL	160	\$543.00
Z038GW3	NON-DRIVE ENDSHIELD - W3	160	\$3,232.00
Z039G	NON-DRIVE ENDSHIELD - OIL SEAL	180	\$509.00
Z039GV	NON-DRIVE ENDSHIELD - VRING SEAL	180	\$398.00
Z039GLAB	NON-DRIVE ENDSHIELD - LABYRINTH SEAL	180	\$790.00
Z039GW3	NON-DRIVE ENDSHIELD - W3	180	\$4,247.00
Z040G	NON-DRIVE ENDSHIELD - OIL SEAL	200	\$746.00
Z040GV	NON-DRIVE ENDSHIELD - VRING SEAL	200	\$482.00
Z040GLAB	NON-DRIVE ENDSHIELD - LABYRINTH SEAL	200	\$1,154.00
Z040GW3	NON-DRIVE ENDSHIELD - W3	200	\$5,261.00
Z042	NON-DRIVE ENDSHIELD	225/250	\$647.00
Z043-2	NON-DRIVE ENDSHIELD	280 2P	\$1,321.00
Z044	NON-DRIVE ENDSHIELD	280/315	\$1,321.00
Z044INS	NON-DRIVE ENDSHIELD - Insulated	280/315	\$3,174.00
Z044-2	NON-DRIVE ENDSHIELD	315 2P	\$1,321.00
Z045	NON-DRIVE ENDSHIELD	355	\$3,115.00
Z045-2	NON-DRIVE ENDSHIELD	355 2P	\$3,115.00
Z031B	NON-DRIVE END LIPSEAL 18 X 12 X 3	63	\$13.00
Z032B	NON-DRIVE END LIPSEAL 23 X 15 X 3	71	\$13.00
Z033B	NON-DRIVE END LIPSEAL 25 X 17 X 3	80	\$13.00
Z034B	NON-DRIVE END LIPSEAL 28 X 20 X 4	90	\$13.00
Z035B	NON-DRIVE END LIPSEAL 32 X 25 X 4	100	\$17.00
Z036B	NON-DRIVE END LIPSEAL 37 X 30 X 4	112	\$24.00
Z037B	NON-DRIVE END LIPSEAL 42 X 35 X 4	132	\$25.00
Z038B	NON-DRIVE END LIPSEAL 55 X 45 X 4	160	\$32.00
Z039B	NON-DRIVE END LIPSEAL 65 X 55 X 5	180	\$46.00
Z040B	NON-DRIVE END LIPSEAL 72 X 60 X 6	200	\$69.00
Z041B	NON-DRIVE END LIPSEAL 80 X 70 X 7	225/250 2/4P, 280/315/355 2P	\$84.00



THREE PHASE IP55 CAST IRON FRAME

PART NUMBER	DESCRIPTION	FRAME	NET PRICE
Z046	FAN BLADE - PLASTIC	63	\$31.00
Z047	FAN BLADE - PLASTIC	71 - 80 2P G	\$36.00
Z048	FAN BLADE - PLASTIC	80 - 90 2/4P G	\$39.00
Z049	FAN BLADE - PLASTIC	90 - 90 6/8P G	\$40.00
Z050	FAN BLADE - PLASTIC	100	\$41.00
Z051	FAN BLADE - PLASTIC	112 - 112 6/8P G	\$43.00
Z051-2	FAN BLADE - PLASTIC	112 2P - 112/132 2/4P G	\$43.00
Z052	FAN BLADE - PLASTIC	132 - 132 6/8P G	\$48.00
Z052-2	FAN BLADE - PLASTIC	132 2P B	\$48.00
Z052-2CI	FAN BLADE - CAST IRON (KEY)	132 2P B	\$154.00
Z053	FAN BLADE - PLASTIC	160	\$64.00
Z053CI	FAN BLADE - CAST IRON (KEY)	160	\$440.00
Z053-2	FAN BLADE - PLASTIC	160 2P	\$64.00
Z054	FAN BLADE - PLASTIC	180	\$96.00
Z054-2	FAN BLADE - PLASTIC	180 2P	\$96.00
Z054-2CI	FAN BLADE - CAST IRON (KEY)	180 2P	\$471.00
Z055	FAN BLADE - PLASTIC	200	\$139.00
Z055-2	FAN BLADE - PLASTIC	200 2P	\$139.00
Z056	FAN BLADE - PLASTIC	225/250 - 225/250 6/8P G	\$249.00
Z056CI	FAN BLADE - CAST IRON (KEY)	225/250 - 225/250 6/8P G	\$594.00
Z056-2	FAN BLADE - PLASTIC	225/250 2P - 225/250 2/4P G	\$249.00
Z056-2CI	FAN BLADE - CAST IRON (KEY)	225/250 2P - 225/250 2/4P G	\$594.00



THREE PHASE IP55 CAST IRON FRAME

PART NUMBER	DESCRIPTION	FRAME	NET PRICE
Z058	FAN BLADE PLASTIC	280 - 280 6/8P G	\$392.00
Z058CI	FAN BLADE - CAST IRON (KEY)	280 - 280 6/8P G	\$939.00
Z058-2	FAN BLADE PLASTIC	280 2P (65mm Hub)	\$392.00
Z058-2CI	FAN BLADE - CAST IRON (KEY)	280 2P - 280/315 2P G	\$939.00
Z059	FAN BLADE PLASTIC	315 - 315 6/8P G	\$758.00
Z059CI	FAN BLADE - CAST IRON (KEY)	315 - 315 6/8P G	\$1,816.00
Z059-2G	FAN BLADE PLASTIC	280/315 4P G (Hub 75)	\$758.00
Z059-2GCI	FAN BLADE - CAST IRON	280/315 4P G (Hub 75)	\$1,816.00
Z059-2	FAN BLADE PLASTIC	280/315 2P (Hub 65mm)	\$1,515.00
Z059-2CI	FAN BLADE - CAST IRON (KEY)	315 2P B	\$1,816.00
Z060	FAN BLADE ALUMINIUM (KEY)	355 4P	\$2,648.00
Z060-6	FAN BLADE ALUMINIUM (KEY)	355 6/8P	\$2,648.00
Z060CI	FAN BLADE - CAST IRON (KEY)	355 4P	\$3,177.00
Z060-6CI	FAN BLADE - CAST IRON (KEY)	355 6/8P	\$3,177.00
Z060-2	FAN BLADE ALUMINIUM (KEY)	355 2P	\$2,648.00
Z060-2CI	FAN BLADE - CAST IRON (KEY)	355 2P	\$3,177.00
Z068	FAN BLADE COVER - CAST IRON	160	\$131.00
Z069	FAN BLADE COVER - CAST IRON	180	\$212.00
Z070	FAN BLADE COVER - CAST IRON	200	\$276.00
Z071	FAN BLADE COVER - CAST IRON	225/250	\$578.00
Z073	FAN BLADE COVER - CAST IRON	280/315	\$1,154.00
Z075	FAN BLADE COVER - CAST IRON	355	\$2,648.00



THREE PHASE IP55 CAST IRON FRAME

PART NUMBER	DESCRIPTION	FRAME	NET PRICE
Z068RHK	RAINHAT KIT	160	\$266.00
Z069RHK	RAINHAT KIT	180	\$324.00
Z070RHK	RAINHAT KIT	200	\$387.00
Z071RHK	RAINHAT KIT	225/250	\$805.00
Z073RHK	RAINHAT KIT	280/315	\$981.00
Z075RHK	RAINHAT KIT	355	\$1,440.00



THREE PHASE IP55 CAST IRON FRAME

PART NUMBER	DESCRIPTION	FRAME	NET PRICE
Z064FC	FORCED COOLED - FAN COVER KIT	90	\$1,412.00
Z065FC	FORCED COOLED - FAN COVER KIT	100	\$1,714.00
Z066FC	FORCED COOLED - FAN COVER KIT	112	\$1,835.00
Z067FC	FORCED COOLED - FAN COVER KIT	132	\$1,976.00
Z068FC	FORCED COOLED - FAN COVER KIT	160	\$2,189.00
Z069FC	FORCED COOLED - FAN COVER KIT	180	\$2,338.00
Z070FC	FORCED COOLED - FAN COVER KIT	200	\$2,618.00
Z071FC	FORCED COOLED - FAN COVER KIT	225/250	\$2,941.00
Z073FC	FORCED COOLED - FAN COVER KIT	280/315	\$3,157.00
Z074FC	FORCED COOLED - FAN COVER KIT	355	\$3,258.00
Z080B	INTERNAL BEARING CAP - BALL BEARING	71/80	\$10.00
Z090B	INTERNAL BEARING CAP - BALL BEARING	90	\$24.00
Z100B	INTERNAL BEARING CAP - BALL BEARING	100	\$24.00
Z112B	INTERNAL BEARING CAP - BALL BEARING	112	\$24.00
Z132B	INTERNAL BEARING CAP - BALL BEARING	132	\$39.00
Z160B	INTERNAL BEARING CAP - BALL BEARING	160	\$56.00
Z180B	INTERNAL BEARING CAP - BALL BEARING	180	\$84.00
Z200B	INTERNAL BEARING CAP - BALL BEARING	200	\$119.00
4001.1336	LIFTING EYE BOLT	112/132	\$36.00
4001.4487	LIFTING EYE BOLT	160/180	\$66.00
4002.7610	LIFTING EYE BOLT	200	\$93.00
4000.1344	LIFTING EYE BOLT	225/250	\$140.00
4000.1352	LIFTING EYE BOLT	280/315	\$243.00
4008.8030	LIFTING EYE BOLT	355	\$443.00
SPRING	COMPRESSION SPRING 17 X 10MM	225/250/280/315/355	\$2.00
HGFBRUSH	BRUSH HOLDER	ALL HGF	\$760.00
HGFBRACKET	BRACKET - BRUSH HOLDER	ALL HGF	\$252.00
HGF0010.5341	BRUSH ONLY - CARBON	ALL HGF	\$88.00
AGFBRUSH	COMPLETE BRUSH ASSEMBLY	ALL AGF	\$217.00



THREE PHASE IP55 CAST IRON FRAME

PART NUMBER	DESCRIPTION	FRAME	TRADE PRICE
SR8090	SLIDE RAILS	80/90	\$173.00
SR100132	SLIDE RAILS	100/112/132	\$222.00
SR160180	SLIDE RAILS	160/180	\$236.00
SR200225	SLIDE RAILS	200/225	\$529.00
SR250280	SLIDE RAILS	250/280	\$1,099.00
SR315355	SLIDE RAILS	315/355	\$1,692.00

PART NUMBER	DESCRIPTION	FRAME	TRADE PRICE
Z063PAD	PAD MOUNTING KIT - Aluminium	63	\$82.00
Z071PAD	PAD MOUNTING KIT - Aluminium	71	\$84.00
Z080PAD	PAD MOUNTING KIT - Aluminium	80	\$92.00
Z090PAD	PAD MOUNTING KIT - Aluminium	90S/L	\$121.00
Z0100PAD	PAD MOUNTING KIT - Aluminium	100L	\$148.00
Z0112PAD	PAD MOUNTING KIT - Aluminium	112M	\$182.00
Z0132PAD	PAD MOUNTING KIT - Aluminium	132S/M	\$229.00
Z063FOOT	FOOT MOUNTING KIT - Aluminium	63	\$82.00
Z071FOOT	FOOT MOUNTING KIT - Aluminium	71	\$84.00
Z080FOOT	FOOT MOUNTING KIT - Aluminium	80	\$92.00
Z090FOOT	FOOT MOUNTING KIT - Aluminium	90S/L	\$121.00
Z0100FOOT	FOOT MOUNTING KIT - Aluminium	100L	\$148.00
Z0112FOOT	FOOT MOUNTING KIT - Aluminium	112M	\$182.00
Z0132SFOOT	FOOT MOUNTING KIT - Aluminium	132S	\$229.00
Z0132MFOOT	FOOT MOUNTING KIT - Aluminium	132M	\$229.00



THREE PHASE IP55 CAST IRON FRAME - BRAKE MOTOR

PART NUMBER	DESCRIPTION	FRAME	NET PRICE
Z003B	TERMINAL BOX - BRAKE MOTOR	63/71/80/90/100	\$82.00
Z005B	TERMINAL BOX - BRAKE MOTOR	112/132	\$93.00
Z006B	TERMINAL BOX - BRAKE MOTOR	160	\$176.00
LENZERECTIFIER	RECTIFIER - 220/230/240V - Brake	ALL	\$136.00
Z062B	FAN COVER - Manual Release	71	\$217.00
Z063B	FAN COVER - Manual Release	80	\$231.00
Z064B	FAN COVER - Manual Release	90	\$249.00
Z065B	FAN COVER - Manual Release	100	\$262.00
Z066B	FAN COVER - Manual Release	112	\$291.00
Z067B	FAN COVER - Manual Release	132	\$350.00
Z068B	FAN COVER - Manual Release	160	\$552.00
Z032BM	NON-DRIVE ENDSHIELD - LIP SEAL	71	\$59.00
Z033BM	NON-DRIVE ENDSHIELD - LIP SEAL	80	\$61.00
Z034BM	NON-DRIVE ENDSHIELD - LIP SEAL	90	\$66.00
Z035BM	NON-DRIVE ENDSHIELD - LIP SEAL	100	\$99.00
Z036BM	NON-DRIVE ENDSHIELD - LIP SEAL	112	\$123.00
Z037BM	NON-DRIVE ENDSHIELD - LIP SEAL	132	\$155.00
Z038BM	NON-DRIVE ENDSHIELD - LIP SEAL	160	\$419.00



THREE PHASE IP55 CAST IRON FRAME - FLAMEPROOF MOTOR

PART NUMBER	DESCRIPTION	FRAME	TRADE PRICE
Z079EXD	FLANGE TYPE "A"	90	\$204.00
Z080EXD	FLANGE TYPE "A"	100	\$252.00
Z081EXD	FLANGE TYPE "A"	112	\$286.00
Z082EXD	FLANGE TYPE "A"	132	\$440.00
Z083EXD	FLANGE TYPE "A"	160	\$593.00
Z084EXD	FLANGE TYPE "A"	180	\$832.00
Z085EXD	FLANGE TYPE "A"	200	\$1,053.00
Z079CEXD	FLANGE TYPE "C" METRIC	90	\$204.00
Z080CEXD	FLANGE TYPE "C" METRIC	100	\$252.00
Z081CEXD	FLANGE TYPE "C" METRIC	112	\$286.00
Z082CEXD	FLANGE TYPE "C" METRIC	132	\$440.00

PART NUMBER	DESCRIPTION	FRAME	NET PRICE
Z001A	TERMINAL BLOCK - KM4	90/100	\$43.00
Z003A	TERMINAL BLOCK - KM5	112/132	\$61.00
Z004A	TERMINAL BLOCK - KM6	160/180	\$108.00
Z005A	TERMINAL BLOCK - KM8	200	\$184.00
Z019EXD	DRIVE ENDSHIELD - LIP SEAL	90	\$150.00
Z020EXD	DRIVE ENDSHIELD - LIP SEAL	100	\$189.00
Z021EXD	DRIVE ENDSHIELD - LIP SEAL	112	\$213.00
Z022EXD	DRIVE ENDSHIELD - LIP SEAL	132	\$327.00
Z023EXD	DRIVE ENDSHIELD - LIP SEAL	160	\$604.00
Z024EXD	DRIVE ENDSHIELD - LIP SEAL	180	\$846.00
Z025EXD	DRIVE ENDSHIELD - LIP SEAL	200	\$1,071.00
Z034EXD	NON-DRIVE ENDSHIELD - LIP SEAL	90	\$150.00
Z035EXD	NON-DRIVE ENDSHIELD - LIP SEAL	100	\$189.00
Z036EXD	NON-DRIVE ENDSHIELD - LIP SEAL	112	\$213.00
Z037EXD	NON-DRIVE ENDSHIELD - LIP SEAL	132	\$327.00
Z038EXD	NON-DRIVE ENDSHIELD - LIP SEAL	160	\$582.00
Z039EXD	NON-DRIVE ENDSHIELD - LIP SEAL	180	\$818.00
Z040EXD	NON-DRIVE ENDSHIELD - LIP SEAL	200	\$1,034.00



THREE PHASE IP55 CAST IRON FRAME - FLAMEPROOF MOTOR

PART NUMBER	DESCRIPTION	FRAME	NET PRICE
Z049EXD	FAN BLADE - CAST IRON	90	\$97.00
Z050EXD	FAN BLADE - CAST IRON	100	\$99.00
Z051EXD	FAN BLADE - CAST IRON	112	\$147.00
Z051-2EXD	FAN BLADE - CAST IRON	112 2P	\$147.00
Z052EXD	FAN BLADE - CAST IRON	132	\$155.00
Z052-2EXD	FAN BLADE - CAST IRON	132 2P	\$155.00
Z053EXD	FAN BLADE - CAST IRON	160	\$440.00
Z053-2EXD	FAN BLADE - CAST IRON	160 2P	\$440.00
Z054EXD	FAN BLADE - CAST IRON	180	\$471.00
Z054-2EXD	FAN BLADE - CAST IRON	180 2P	\$471.00
Z055EXD	FAN BLADE - CAST IRON	200	\$509.00
Z055-2EXD	FAN BLADE - CAST IRON	200 2P	\$509.00
Z064EXD	FAN BLADE COVER	90	\$66.00
Z065EXD	FAN BLADE COVER	100	\$80.00
Z066EXD	FAN BLADE COVER	112	\$89.00
Z067EXD	FAN BLADE COVER	132	\$139.00
Z068EXD	FAN BLADE COVER	160	\$257.00
Z069EXD	FAN BLADE COVER	180	\$362.00
Z070EXD	FAN BLADE COVER	200	\$459.00



SINGLE PHASE NEMA FRAME New Model (Post 00) IP55

PART NUMBER	DESCRIPTION	FRAME	TRADE PRICE
Z134	FLANGE TYPE FC149 TEFC	V4000018,25,37, MT-08	\$98.00
Z135	FLANGE TYPE FC149 TEFC	V4000055,75,110,150,V2000075,150	\$98.00
Z56133	FLANGE TYPE "C" TEFC	V4000018,25,37	N/A
Z56136	FLANGE TYPE "C" TEFC	V4000055,75,110,150,V2000075,150	\$106.00

PART NUMBER	DESCRIPTION	FRAME	NET PRICE
Z106N	TERMINAL BOX 1PH TEFC	ALL	\$57.00
Z112N	DRIVE ENDSHIELD TEFC	V4000018,25,37	\$66.00
Z113N	DRIVE ENDSHIELD TEFC	V4000055,75,110,150,V2000075,150	\$66.00
Z108	NON-DRIVE ENDSHIELD TEFC	V4000018,25,37,55,75,V2000075	\$56.00
Z109	NON-DRIVE ENDSHIELD TEFC	V4000110,150,V2000150	\$56.00
Z114A	MRT OVERLOAD F36635/49	V4000025	\$63.00
Z114B	MRT OVERLOAD F36626/49	V4000018	\$63.00
Z115A	MRT OVERLOAD F36619/49	V4000037	\$63.00
Z116A	MRT OVERLOAD B40127/89	V4000055	\$63.00
Z117A	MRT OVERLOAD B40130/89	V4000075	\$63.00
Z118B	MRT OVERLOAD B40251/89	V2000075	\$63.00
Z119A	MRT OVERLOAD B40239/89	V2000150	\$63.00
Z119B	MRT OVERLOAD B40244/89	V4000150	\$63.00
Z120A	MRT OVERLOAD B40139/89	V4000110	\$63.00
Z049	FAN BLADE TEFC	ALL	\$40.00
Z143N	FAN BLADE COVER TEFC	ALL	\$43.00
Z146	CENTRIFUGAL MECHANISM 2P 16mm Bore	V2000075	\$55.00
Z147	CENTRIFUGAL MECHANISM 2P 18mm Bore	V2000150	\$55.00
Z149	CENTRIFUGAL MECHANISM 4P 16mm Bore	V4000018,25,37,55,75	\$55.00
Z150	CENTRIFUGAL MECHANISM 4P 18mm Bore	V4000110,150	\$55.00
Z152N	STATIONARY SWITCH SMALL 2 Leads	V4000018,25,37	\$55.00
Z153DC	STATIONARY SWITCH LARGE 3 Leads	V4000055,75,110,150,V2000075,150	\$55.00
Z155A	CAPACITOR COVER SHORT FAT	V4000018,25,37	\$28.00
Z156A	CAPACITOR COVER LONG FAT	V4000055,75,110,150,V2000075,150	\$28.00
CAP-05	RUN CAPACITOR 5 MFD 400V	V4000055,75,V2000075	*
CAP-10	RUN CAPACITOR 10 MFD 400V	V2000150	*
CAP-15	RUN CAPACITOR 15 MFD 400V	V4000110	*
CAP-25	RUN CAPACITOR 25 MFD 400V	V4000150	*

* Please find pricing for Capacitors at the Back of W21 Spares Section



SINGLE PHASE NEMA FRAME New Model (Post 00) IP55

PART NUMBER	DESCRIPTION	FRAME	TRADE PRICE
CAP-115145	START CAPACITOR 115-145 MFD 250V	V4000055,75,V2000075	*
CAP-145174	START CAPACITOR 145-174 MFD 250V	V4000110,150	*
CAP-161193	START CAPACITOR 161-193 MFD 110V	V4000018	*
CAP-189227-2	START CAPACITOR 189-227 MFD 250V	V2000150	*
CAP-5364	START CAPACITOR 53-64 MFD 250V	V4000025	*
CAP-88108-2	START CAPACITOR 88-108 MFD 250V	V4000037	*

SINGLE PHASE NEMA FRAME New Model (Post 00) IP21

PART NUMBER	DESCRIPTION	FRAME	NET PRICE
Z110DP	DRIVE ENDSHIELD ODP	U4000018,25,37	\$56.00
Z111	NON-DRIVE ENDSHIELD ODP	U4000018,25,37	\$92.00
Z114B	MRT OVERLOAD F36626/49	U4000018	\$63.00
Z115B	MRT OVERLOAD F36611/49	U4000025	\$63.00
Z116B	MRT OVERLOAD F36606/49	U4000037	\$63.00
Z136	FAN BLADE	U4000018,25,37	\$39.00
Z149	CENTRIFUGAL MECHANISM 4P 16mm Bore	U4000018,25,37	\$55.00
Z152N	STATIONARY SWITCH SMALL 2 Leads	U4000018,25,37	\$55.00
Z154A	CAPACITOR COVER SHORT THIN	U4000018,25,37	\$28.00
CAP-189227	START CAPACITOR 189-227 MFD 110V	U4000018	*
CAP-5364	START CAPACITOR 53-64 MFD 250V	U4000025	*
CAP-88108	START CAPACITOR 88-108 MFD 110V	U4000037	*

SINGLE PHASE NEMA FRAME New Model (Post 00) IP21 Compressor Motor

PART NUMBER	DESCRIPTION	FRAME	NET PRICE
Z133DP	DRIVE ENDSHIELD ODP	ALL	\$56.00
Z109DP	NON-DRIVE ENDSHIELD ODP	ALL	\$66.00
Z121A	MRT OVERLOAD B40240/89	U2000170C	\$63.00
Z119B	MRT OVERLOAD B40244/89	U2000220C	\$63.00
Z049DP	FAN BLADE	ALL	\$40.00
Z147	CENTRIFUGAL MECHANISM	ALL	\$55.00
Z153DC	STATIONARY SWITCH LARGE 3 Leads	ALL	\$55.00
Z155A	CAPACITOR COVER SHORT FAT	ALL	\$28.00
Z156A	CAPACITOR COVER SHORT LONG	ALL	\$28.00
CAP-216259-2	START CAPACITOR 216-259 MFD 250V	ALL	*
CAP-15	RUN CAPACITOR 15MFD 400V	ALL	*

* Please find pricing for Capacitors at the Back of W21 Spares Section



DUAL VOLTAGE IP55 CAST IRON FRAME

PART NUMBER	DESCRIPTION	FRAME	TRADE PRICE
Z079	FLANGE TYPE "A"	90	\$147.00
Z080	FLANGE TYPE "A"	100	\$153.00
Z081	FLANGE TYPE "A"	112	\$185.00
Z082	FLANGE TYPE "A"	132	\$210.00
Z079C	FLANGE TYPE "C" METRIC	90	\$147.00
Z080C	FLANGE TYPE "C" METRIC	100	\$153.00
Z081C	FLANGE TYPE "C" METRIC	112	\$185.00
Z082C	FLANGE TYPE "C" METRIC	132	\$210.00

PART NUMBER	DESCRIPTION	FRAME	NET PRICE
Z003DV	TERMINAL BOX	90/100	\$170.00
Z004DV	TERMINAL BOX	112	\$173.00
Z005DV	TERMINAL BOX	132	\$183.00
Z019V	DRIVE ENDSHIELD - VRING SEAL	90	\$48.00
Z020V	DRIVE ENDSHIELD - VRING SEAL	100	\$56.00
Z021V	DRIVE ENDSHIELD - VRING SEAL	112	\$71.00
Z022V	DRIVE ENDSHIELD - VRING SEAL	132	\$134.00
Z163	NON-DRIVE ENDSHIELD DV	90	\$110.00
Z164A	NON-DRIVE ENDSHIELD DV	100	\$125.00
Z164	NON-DRIVE ENDSHIELD DV	112	\$135.00
Z165	NON-DRIVE ENDSHIELD DV	132	\$160.00
Z049	FAN BLADE - PLASTIC	90	\$40.00
Z050	FAN BLADE - PLASTIC	100	\$41.00
Z051	FAN BLADE - PLASTIC	112	\$43.00
Z051-2	FAN BLADE - PLASTIC	112 2P	\$43.00
Z052	FAN BLADE - PLASTIC	132	\$48.00
Z052-2	FAN BLADE - PLASTIC	132 2P	\$48.00
Z147	CENTRIFUGAL MECHANISM	90 2P	\$55.00
Z150	CENTRIFUGAL MECHANISM	90 4P	\$55.00
Z176	CENTRIFUGAL MECHANISM	100/112/132 2P	\$66.00
Z179	CENTRIFUGAL MECHANISM	100/112/132 4P	\$66.00
Z181	STATIONARY SWITCH	90	\$55.00
Z182	STATIONARY SWITCH	100/112/132	\$66.00



DUAL VOLTAGE IP55 CAST IRON FRAME

PART NUMBER	DESCRIPTION	FRAME	TRADE PRICE
CAP-30	RUN CAPACITOR 30 MFD 400V	ME-17 ME-20 ME-24 ME-16 ME-18	*
CAP-20	RUN CAPACITOR 20 MFD 400V	ME-14 ME-24	*
CAP-40	RUN CAPACITOR 40 MFD 400V	ME-21 ME-25	*
CAP-50	RUN CAPACITOR 50 MFD 400V	ME-25	*
CAP-189227-2	START CAPACITOR 189-227 MFD 250V	ME-17	*
CAP-216259-2	START CAPACITOR 216-259 MFD 250V	ME-20 ME-24	*
CAP-270324-2	START CAPACITOR 270-324 MFD 250V	ME-24 ME-16 ME-18 ME-21 ME-25	*
CAP-161193-2	START CAPACITOR 161-193 MFD 250V	ME-14	*

SINGLE PHASE IEC IP55

PART NUMBER	DESCRIPTION	FRAME	TRADE PRICE
Z077	FLANGE TYPE "A"	71	\$118.00
Z078	FLANGE TYPE "A"	80	\$123.00
Z079	FLANGE TYPE "A"	90	\$147.00
Z080	FLANGE TYPE "A"	100	\$153.00
Z077C	FLANGE TYPE "C" METRIC	71	\$118.00
Z078C	FLANGE TYPE "C" METRIC	80	\$123.00
Z079C	FLANGE TYPE "C" METRIC	90	\$147.00
Z080C	FLANGE TYPE "C" METRIC	100	\$153.00

PART NUMBER	DESCRIPTION	FRAME	NET PRICE
Z005M	TERMINAL BOX	71/80/90/100	\$143.00
Z017V	DRIVE ENDSHIELD - VRING SEAL	71	\$40.00
Z018V	DRIVE ENDSHIELD - VRING SEAL	80	\$43.00
Z019V	DRIVE ENDSHIELD - VRING SEAL	90	\$48.00
Z020V	DRIVE ENDSHIELD - VRING SEAL	100	\$56.00
Z161	NON-DRIVE ENDSHIELD	71	\$88.00
Z162	NON-DRIVE ENDSHIELD	80	\$92.00
Z163	NON-DRIVE ENDSHIELD	90	\$110.00
Z164A	NON-DRIVE ENDSHIELD	100	\$125.00

* Please find pricing for Capacitors at the Back of W21 Spares Section



SINGLE PHASE IEC IP55

PART NUMBER	DESCRIPTION	FRAME	NET PRICE
Z114A	MRT OVERLOAD F36635/49	L4000037	\$63.00
Z117B	MRT OVERLOAD B40227/89	L4000055	\$63.00
Z117A	MRT OVERLOAD B40130/89	L4000075, WEG-07TFF/W	\$63.00
Z120A	MRT OVERLOAD B40139/89	L4000110	\$63.00
Z118A	MRT OVERLOAD B40242/89	WEG-09TFF/W	\$63.00
Z119B	MRT OVERLOAD B40244/89	L4000150	\$63.00
Z121B	MRT OVERLOAD B44146/89	L4000220	\$63.00
Z047	FAN BLADE - PLASTIC	71	\$36.00
Z048	FAN BLADE - PLASTIC	80	\$39.00
Z049	FAN BLADE - PLASTIC	90	\$40.00
Z050	FAN BLADE - PLASTIC	100	\$41.00
Z150A	CENTRIFUGAL MECHANISM	L4000037	\$55.00
Z150	CENTRIFUGAL MECHANISM	L4000055, 75, 110, 150	\$55.00
Z179	CENTRIFUGAL MECHANISM	L4000220	\$66.00
Z146A	CENTRIFUGAL MECHANISM	WEG-07TFF/W WEG-09TFF/W	\$55.00
Z152A	STATIONARY SWITCH	L4000037	\$55.00
Z152B	STATIONARY SWITCH	L4000055, 75, 07TFF/W, 09TFF/W	\$55.00
Z181	STATIONARY SWITCH	L4000110, 150	\$55.00
Z182	STATIONARY SWITCH	L4000220	\$66.00
CAP-15	RUN CAPACITOR 15MFD 400V	L4000037, 75	*
CAP-10	RUN CAPACITOR 10MFD 400V	L4000055	*
CAP-12	RUN CAPACITOR 12MFD 400V	L4000110	*
CAP-20	RUN CAPACITOR 20MFD 400V	L4000150	*
CAP-30	RUN CAPACITOR 30MFD 400V	L4000220	*
CAP-88108-2	START CAPACITOR 88-108MFD 250V	L4000037	*
CAP-115145	START CAPACITOR 115-145MFD 250V	L4000055	*
CAP-145174	START CAPACITOR 145-174MFD 250V	L4000075	*
CAP-161193-2	START CAPACITOR 161-193MFD 250V	L4000110, 150	*
CAP-270324-2	START CAPACITOR 270-324MFD 250V	L4000220	*

* Please find pricing for Capacitors at the Back of W21 Spares Section



CAPACITORS

PART NUMBER	DESCRIPTION	TRADE PRICE
CAP-02	RUN CAPACITOR 2 MFD 400V 50/60HZ Fast On (TD) 25x56	\$20.00
CAP-02W	RUN CAPACITOR 2 MFD 400V 50/60HZ Wire (TF200) 25x56	\$20.00
CAP-03	RUN CAPACITOR 3 MFD 400V 50/60HZ Fast On (TD) 25x56	\$22.00
CAP-03W	RUN CAPACITOR 3 MFD 400V 50/60HZ Wire (TF200) 25x56	\$21.00
CAP-04	RUN CAPACITOR 4 MFD 400V 50/60HZ Fast On (TD) 25x56	\$23.00
CAP-04W	RUN CAPACITOR 4 MFD 400V 50/60HZ Wire (TF200) 25x56	\$22.00
CAP-05	RUN CAPACITOR 5 MFD 400V 50/60HZ Fast On (TD) 30x56	\$23.00
CAP-05W	RUN CAPACITOR 5 MFD 400V 50/60HZ Wire (TF200) 30x56	\$23.00
CAP-06	RUN CAPACITOR 6 MFD 400V 50/60HZ Fast On (TD) 30x56	\$25.00
CAP-06W	RUN CAPACITOR 6 MFD 400V 50/60HZ Wire (TF200) 30x56	\$23.00
CAP-07	RUN CAPACITOR 7 MFD 400V 50/60HZ Fast On (TD) 30x56	\$26.00
CAP-07W	RUN CAPACITOR 7 MFD 400V 50/60HZ Wire (TF200) 30x56	\$25.00
CAP-08	RUN CAPACITOR 8 MFD 400V 50/60HZ Fast On (TD) 35x56	\$29.00
CAP-08W	RUN CAPACITOR 8 MFD 400V 50/60HZ Wire (TF200) 35x56	\$28.00
CAP-09	RUN CAPACITOR 9 MFD 400V 50/60HZ Fast On (TD) 35x56	\$30.00
CAP-09W	RUN CAPACITOR 9 MFD 400V 50/60HZ Wire (TF200) 35x56	\$29.00
CAP-10	RUN CAPACITOR 10 MFD 400V 50/60HZ Fast On (TD) 35x56	\$30.00
CAP-10W	RUN CAPACITOR 10 MFD 400V 50/60HZ Wire (TF200) 35x56	\$29.00
CAP-12	RUN CAPACITOR 12 MFD 400V 50/60HZ Fast On (TD) 35x56	\$31.00
CAP-12W	RUN CAPACITOR 12 MFD 400V 50/60HZ Wire (TF200) 35x56	\$31.00
CAP-14	RUN CAPACITOR 14 MFD 400V 50/60HZ Fast On (TD) 35x74	\$39.00
CAP-14W	RUN CAPACITOR 14 MFD 400V 50/60HZ Wire (TF200) 35x74	\$38.00
CAP-15	RUN CAPACITOR 15 MFD 400V 50/60HZ Fast On (TD) 35x74	\$41.00
CAP-15W	RUN CAPACITOR 15 MFD 400V 50/60HZ Wire (TF200) 35x74	\$39.00
CAP-16	RUN CAPACITOR 16 MFD 400V 50/60HZ Fast On (TD) 35x74	\$44.00
CAP-16W	RUN CAPACITOR 16 MFD 400V 50/60HZ Wire (TF200) 35x74	\$43.00
CAP-18	RUN CAPACITOR 18 MFD 400V 50/60HZ Fast On (TD) 40x74	\$49.00
CAP-18W	RUN CAPACITOR 18 MFD 400V 50/60HZ Wire (TF200) 40x74	\$48.00
CAP-20	RUN CAPACITOR 20 MFD 400V 50/60HZ Fast On (TD) 40x74	\$51.00
CAP-20W	RUN CAPACITOR 20 MFD 400V 50/60HZ Wire (TF200) 40x74	\$49.00
CAP-25	RUN CAPACITOR 25 MFD 400V 50/60HZ Fast On (TD) 40x94	\$59.00
CAP-25TS	RUN CAPACITOR 25 MFD 400V 50/60HZ Fast On (TS) 40x94	\$59.00
CAP-25W	RUN CAPACITOR 25 MFD 400V 50/60HZ Wire (TF200) 40x94	\$56.00
CAP-30	RUN CAPACITOR 30 MFD 400V 50/60HZ Fast On (TD) 40x94	\$67.00
CAP-30W	RUN CAPACITOR 30 MFD 400V 50/60HZ Wire (TF200) 40x94	\$66.00
CAP-35	RUN CAPACITOR 35 MFD 400V 50/60HZ Fast On (TD) 45x94	\$77.00
CAP-35W	RUN CAPACITOR 35 MFD 400V 50/60HZ Wire (TF200) 45x94	\$75.00
CAP-40	RUN CAPACITOR 40 MFD 400V 50/60HZ Fast On (TD) 45x94	\$82.00
CAP-40W	RUN CAPACITOR 40 MFD 400V 50/60HZ Wire (TF200) 45x94	\$79.00
CAP-45	RUN CAPACITOR 45 MFD 400V 50/60HZ Fast On (TD) 45x94	\$93.00
CAP-45W	RUN CAPACITOR 45 MFD 400V 50/60HZ Wire (TF200) 45x94	\$90.00
CAP-50	RUN CAPACITOR 50 MFD 400V 50/60HZ Fast On (TD) 45x94	\$99.00
CAP-50W	RUN CAPACITOR 50 MFD 400V 50/60HZ Wire (TF200) 45x94	\$97.00
CAP-60	RUN CAPACITOR 60 MFD 400V 50/60HZ Fast On (TD) 60x85	\$208.00
CAP-60W	RUN CAPACITOR 60 MFD 400V 50/60HZ Wire (TF200) 60x85	\$202.00
CAP-5364	START CAPACITOR 053-064 MFD 250V 37x85	\$92.00
CAP-88108-2	START CAPACITOR 088-108 MFD 250V 37x86	\$95.00
CAP-115145	START CAPACITOR 115-145 MFD 250V 37x85	\$107.00
CAP-145174	START CAPACITOR 145-174 MFD 250V 32x85	\$122.00
CAP-161193-2	START CAPACITOR 161-193 MFD 250V A2167 37x85	\$132.00
CAP-189227-2	START CAPACITOR 189-227 MFD 250V 37x85	\$141.00
CAP-216259-2	START CAPACITOR 216-259 MFD 250V 46x85	\$162.00
CAP-270324-2	START CAPACITOR 270-324 MFD 250V 46x86	\$171.00
CAP-340408	START CAPACITOR 340-408 MFD 250V 46x85	\$182.00
CAP-430516	START CAPACITOR 430-516 MFD 250V 46x110	\$217.00
CAP-540648	START CAPACITOR 540-648 MFD 250V 45x110	\$228.00
CAP-88108	START CAPACITOR 088-108 MFD 110V 37x85	\$49.00
CAP-161193	START CAPACITOR 161-193 MFD 110V A0167 37x85	\$61.00

Prices Exclude GST and are subject to change at any time Ref: V24

W22 DUST IGNITION PROOF Ex tb (Zone 21)

WEG Dust Ignition Proof motors are designed to prevent the occurrence during normal operating and certain specific abnormal conditions of arcs, sparks and excessive overheating of all inner and outer surfaces.



Range 0.12kW to 500kW



2, 4, 6 and 8 Pole



Improved Thermal Performance



IECEX Certification



Highly Reliable



Electrical:

- Class "H" insulation ("B" Temperature Rise: 80 K)
- Ambient temperature: 40 °C 1000 at masl
- Voltages: 220-240/380-415 V - 50 Hz (up to frame 100L) 380-415/660 V - 50 Hz (frame 112M and above)//440-460 V- 60 Hz
- Service Factor (SF): 1.00
- Design: N
- Continuous duty: S1
- Terminal block (6 pins) - (63 up to 100 - Type K1M5 and 355A/B Type HGF Line)
- Thermistors 140 °C (1/phase) all frames
- Dip and baked impregnation (frames 63 up to 200) Resin continuous flow impregnation (frames 225S/M up to 315S/M)

Mechanical:

- Squirrel cage rotor (Aluminium die Cast)
- Enclosure: TEFC (Totally Enclosed Fan Cooled)
- Mounting: B3R(E)
- WSeal (frame 225 and up), Oil Seal Double Lips (frame 63 up to 200)
- Grease nipple system in frame 160 and above
- Metric threaded cable entries
- Solid and Integrated Feet
- Ball bearings
- Shaft material: AISI 1045 (up to frame 315S/M) and AISI 4140 (315L - 355M/L)
- Conductive plastic fan and aluminium fan for 355M/L (2 poles) and 315L, 355M/L and 355A/B (4 poles and up)

Nameplate Marking: Ex tb IIIC T125°C Db IP66

Certification Number: IECEx Bas 10.0099X



2 POLE

3000 RPM Three Phase Cast Iron Frame TEFC, W22 High Efficiency "IE3" Ex tb (Zone 21) IP66

Ex tb IIIC T125°C Db with IECEX Certification Multivoltage 380 - 415 Volt 50HZ, 63 to 355 Frame Class "H" Insulation

1 x PTC Thermistor per Phase rated at 140°C

160 Frame & Above Fitted with Grease Nipple & Grease Release Valve

PART NUMBER	KW	HP	RPM	FRAME	WEIGHT KG	FLC AMPS	SHAFT SIZE	TRADE PRICE		
								B3 FOOT	B14, B5, V1 FLANGE ONLY	B34, B35 FT & FLANGE
WC2000012	0.12	0.16	2820	63	7	0.375	11mm j6	\$699.00		\$762.00
WC2000018	0.18	0.25	2860	63	8	0.533	11mm j6	\$699.00		\$762.00
WC2000025	0.25	0.33	2805	63	7.9	0.672	11mm j6	\$741.00		\$808.00
WC2000037	0.37	0.5	2820	71	10.5	0.851	14mm j6	\$853.00	\$885.00	\$926.00
WC2000055	0.55	0.75	2830	71	11	1.19	14mm j6	\$853.00	\$885.00	\$926.00
WC2000075	0.75	1	2860	80	14.1	1.65	19mm j6	\$1,058.00	\$1,098.00	\$1,151.00
WC2000110	1.1	1.5	2835	80	15	2.39	19mm j6	\$1,155.00	\$1,201.00	\$1,259.00
WC2000150	1.5	2	2885	90S	21.5	3.17	24mm j6	\$1,298.00	\$1,349.00	\$1,417.00
WC2000220	2.2	3	2870	90L	24.5	4.43	24mm j6	\$1,457.00	\$1,515.00	\$1,588.00
WC2000300	3	4	2900	100L	35	5.78	28mm j6	\$1,942.00	\$2,018.00	\$2,114.00
WC2000400R	4	5.5	2900	100L	37	7.82	28mm j6	\$2,192.00	\$2,281.00	\$2,391.00
WC2000400	4	5.5	2900	112M	41	7.59	28mm j6	\$2,265.00	\$2,356.00	\$2,469.00
WC2000550R	5.5	7.5	2880	112M	46	10.5	28mm j6	\$2,771.00	\$2,880.00	\$3,020.00
WC2000550	5.5	7.5	2940	132S	62	10.6	38mm k6	\$2,941.00	\$3,059.00	\$3,206.00
WC2000750	7.5	10	2925	132S	70	14.1	38mm k6	\$3,302.00	\$3,435.00	\$3,598.00
WC2001100R	11	15	2925	132M	84	19.6	38mm k6	\$5,026.00	\$5,228.00	\$5,479.00
WC2001100	11	15	2950	160M	115	20.4	42mm k6	\$5,088.00	\$5,292.00	\$5,547.00
WC2001500	15	20	2945	160M	120	27.7	42mm k6	\$6,041.00	\$6,283.00	\$6,585.00
WC2001850	18.5	25	2945	160L	135	33.9	42mm k6	\$7,145.00	\$7,429.00	\$7,785.00
WC2002200	22	30	2960	180M	170	39.8	48mm k6	\$8,922.00	\$9,279.00	\$9,725.00
WC2003000	30	40	2965	200L	235	54.5	55mm m6	\$11,021.00		\$12,011.00
WC2003700	37	50	2960	200L	250	67.8	55mm m6	POA		POA
WC2004500	45	60	2960	225S/M	380	77.5	55mm m6	POA		POA
WC2005500	55	75	2965	250S/M	460	97.8	60mm m6	POA		POA
WC2007500	75	100	2965	250S/M	500	128	60mm m6	POA		POA
WC2009000	90	125	2976	280S/M	710	153	65mm m6	POA		POA
WC2011000	110	150	2976	280S/M	790	187	65mm m6	POA		POA
WC2013200	132	175	2980	315S/M	950	224	65mm m6	POA		POA
WC2015000	150	200	2979	315S/M	1050	254	65mm m6	POA		POA
WC2018500	185	250	2978	315S/M	1110	317	65mm m6	POA		POA
WC2020000	200	270	2975	315S/M	1200	334	65mm m6	POA		POA
WC2022000	220	300	2985	355M/L	1600	363	75mm m6	POA		POA
WC2025000	250	340	2984	355M/L	1750	413	75mm m6	POA		POA
WC2028000	280	380	2985	355M/L	1800	468	75mm m6	POA		POA
WC2031500	315	430	2983	355M/L	1950	520	75mm m6	POA		POA



4 POLE

1500 RPM Three Phase Cast Iron Frame TEFC, W22 High Efficiency "IE3" Ex tb (Zone 21) IP66

Ex tb IIIC T125°C Db with IECEx Certification Multivoltage 380 - 415 Volt 50HZ, 63 to 355 Frame Class "H" Insulation

1 x PTC Thermistor per Phase rated at 140°C

160 Frame & Above Fitted with Grease Nipple & Grease Release Valve

PART NUMBER	KW	HP	RPM	FRAME	WEIGHT KG	FLC AMPS	SHAFT SIZE	TRADE PRICE		
								B3 FOOT	B14, B5, V1 FLANGE ONLY	B34, B35 FT & FLANGE
WC4000012	0.12	0.16	1370	63	7	0.366	11mm j6	\$658.00		\$718.00
WC4000018	0.18	0.25	1380	63	8	0.516	11mm j6	\$658.00	\$683.00	\$718.00
WC4000025	0.25	0.33	1410	71	8	0.682	14mm j6	\$687.00	\$717.00	\$748.00
WC4000037	0.37	0.5	1385	71	9.5	0.987	14mm j6	\$699.00	\$727.00	\$762.00
WC4000055	0.55	0.75	1425	80	12.5	1.23	19mm j6	\$842.00	\$877.00	\$920.00
WC4000075	0.75	1	1435	L80	14.5	1.68	19mm j6	\$971.00	\$1,008.00	\$1,059.00
WC4000110	1.1	1.5	1445	90S	19.5	2.35	24mm j6	\$1,182.00	\$1,230.00	\$1,287.00
WC4000150	1.5	2	1445	90L	23	3.21	24mm j6	\$1,327.00	\$1,381.00	\$1,446.00
WC4000220	2.2	3	1435	100L	31.5	4.62	28mm j6	\$1,631.00	\$1,695.00	\$1,779.00
WC4000300	3	4	1440	L100L	37.5	6.15	28mm j6	\$1,890.00	\$1,968.00	\$2,061.00
WC4000400	4	5.5	1450	112M	44	8.34	28mm j6	\$2,358.00	\$2,453.00	\$2,570.00
WC4000550	5.5	7.5	1465	132S	66	10.5	38mm k6	\$3,062.00	\$3,183.00	\$3,335.00
WC4000750	7.5	10	1460	132M	74	14.2	38mm k6	\$3,610.00	\$3,754.00	\$3,933.00
WC4000920	9.2	12.5	1465	132M/L	82	17.8	38mm k6	\$4,541.00		\$4,949.00
WC4001100	11	15	1475	160M	113	20.9	42mm k6	\$5,244.00	\$5,457.00	\$5,718.00
WC4001500	15	20	1470	160L	140	28.3	42mm k6	\$5,993.00		\$6,532.00
WC4001850	18.5	25	1470	180M	188	35.2	48mm k6	\$8,141.00		\$8,872.00
WC4002200	22	30	1470	180L	185	41	48mm k6	\$9,087.00		\$9,906.00
WC4003000	30	40	1480	200L	228	57.1	55mm m6	\$11,297.00		\$12,311.00
WC4003700	37	50	1480	225S/M	365	69.2	60mm m6	POA		POA
WC4004500	45	60	1480	225S/M	400	81.9	60mm m6	POA		POA
WC4005500	55	75	1480	250S/M	500	98.6	70mm m6	POA		POA
WC4007500	75	100	1480	250S/M	530	131	70mm m6	POA		POA
WC4009000	90	125	1485	280S/M	700	160	80mm m6	POA		POA
WC4011000	110	150	1485	280S/M	800	195	80mm m6	POA		POA
WC4013200	132	175	1490	315S/M	1010	231	85mm m6	POA		POA
WC4015000	150	200	1490	315S/M	1030	266	85mm m6	POA		POA
WC4018500	185	250	1491	315S/M	1150	327	85mm m6	POA		POA
WC4020000	200	270	1488	315S/M	1250	346	85mm m6	POA		POA
WC4022000	220	300	1492	355M/L	1510	393	100mm m6	POA		POA
WC4025000	250	340	1490	355M/L	1555	436	100mm m6	POA		POA
WC4028000	280	380	1490	355M/L	1600	488	100mm m6	POA		POA
WC4030000	300	400	1490	355M/L	1650	530	100mm m6	POA		POA
WC4031500	315	430	1491	355M/L	1750	562	100mm m6	POA		POA
WC4033000	330	450	1490	355M/L	1810	583	100mm m6	POA		POA
WC4035500	355	480	1490	355M/L	1878	618	100mm m6	POA		POA



6 POLE

1000 RPM Three Phase Cast Iron Frame TEFC, W22 High Efficiency "IE3" Ex tb (Zone 21) IP66

Ex tb IIIC T125°C Db with IECEx Certification Multivoltage 380 - 415 Volt 50HZ, 63 to 355 Frame Class "H" Insulation

1 x PTC Thermistor per Phase rated at 140°C

160 Frame & Above Fitted with Grease Nipple & Grease Release Valve

PART NUMBER	KW	HP	RPM	FRAME	WEIGHT KG	FLC AMPS	SHAFT SIZE	TRADE PRICE		
								B3 FOOT	B14, B5, V1 FLANGE ONLY	B34, B35 FT & FLANGE
WC6000025	0.25	0.33	890	71	12	0.76	14mm j6	\$941.00		\$1,026.00
WC6000037	0.37	0.5	925	80	12.5	0.969	19mm j6	\$957.00		\$1,043.00
WC6000055	0.55	0.75	945	L80	15.5	1.49	19mm j6	\$1,093.00		\$1,189.00
WC6000075	0.75	1	950	L90S	22	1.93	24mm j6	\$1,283.00		\$1,398.00
WC6000110	1.1	1.5	935	90L	25.3	2.78	24mm j6	\$1,510.00		\$1,646.00
WC6000150	1.5	2	955	100L	32	3.7	28mm j6	\$1,779.00		\$1,940.00
WC6000220	2.2	3	960	112M	46	5.29	28mm j6	\$2,123.00		\$2,313.00
WC6000300	3	4	970	132S	65	6.93	38mm k6	\$3,108.00		\$3,389.00
WC6000400	4	5.5	965	132M	70	9.11	38mm k6	\$3,545.00		\$3,864.00
WC6000550	5.5	7.5	970	132M/L	78	12.9	38mm k6	\$4,153.00		\$4,527.00
WC6000750	7.5	10	975	160M	118	15.2	42mm k6	\$4,857.00		\$5,295.00
WC6001100	11	15	978	160L	140	22.8	42mm k6	\$6,758.00		\$7,366.00
WC6001500	15	20	977	180L	185	28.2	48mm k6	\$8,840.00		\$9,633.00
WC6001850	18.5	25	980	200L	215	35.9	55mm m6	\$11,616.00		\$12,661.00
WC6002200	22	30	980	200L	225	42.4	55mm m6	\$13,868.00		\$15,115.00
WC6003000	30	40	980	225S/M	380	56	60mm m6	\$18,680.00		\$20,363.00
WC6003700	37	50	985	250S/M	430	67.2	70mm m6	POA		POA
WC6004500	45	60	985	250S/M	490	79.5	70mm m6	POA		POA
WC6005500	55	75	988	280S/M	665	103	80mm m6	POA		POA
WC6007500	75	100	990	280S/M	725	141	80mm m6	POA		POA
WC6009000	90	125	990	315S/M	990	165	85mm m6	POA		POA
WC6011000	110	150	990	315S/M	1040	201	85mm m6	POA		POA
WC6013200	132	175	992	315S/M	1100	243	85mm m6	POA		POA
WC6015000	150	200	993	355M/L	1440	283	100mm m6	POA		POA
WC6018500	185	250	994	355M/L	1550	362	100mm m6	POA		POA
WC6022000	220	300	994	355M/L	1710	419	100mm m6	POA		POA
WC6025000	250	340	993	355M/L	1830	476	100mm m6	POA		POA
WC6030000	300	400	992	355M/L	2493	564	100mm m6	POA		POA



8 POLE

750 RPM Three Phase Cast Iron Frame TEFC, W22 High Efficiency "IE3" Ex tb (Zone 21) IP66

Ex tb IIIC T125°C Db with IECEx Certification Multivoltage 380 - 415 Volt 50HZ, 63 to 355 Frame Class "H" Insulation

1 x PTC Thermistor per Phase rated at 140°C

160 Frame & Above Fitted with Grease Nipple & Grease Release Valve

PART NUMBER	KW	HP	RPM	FRAME	WEIGHT KG	FLC AMPS	SHAFT SIZE	TRADE PRICE		
								B3 FOOT	B14, B5, V1 FLANGE ONLY	B34, B35 FT & FLANGE
WC8000025	0.25	0.33	695	80	14.5	0.894	19mmj6	\$1,311.00		\$1,430.00
WC8000037	0.37	0.5	700	90S	19	1.24	24mm j6	\$1,351.00		\$1,473.00
WC8000055	0.55	0.75	695	90L	23	1.62	24mm j6	\$1,462.00		\$1,592.00
WC8000075	0.75	1	710	100L	30.5	2.31	28mm j6	\$1,915.00		\$2,089.00
WC8000110	1.1	1.5	710	100L	33	3.3	28mm j6	\$2,151.00		\$2,343.00
WC8000150	1.5	2	705	112M	43	3.98	28mm j6	\$2,424.00		\$2,644.00
WC8000220	2.2	3	710	132S	69	5.37	38mm k6	\$3,364.00		\$3,666.00
WC8000300	3	4	710	132M	75	7.2	38mm k6	\$3,909.00		\$4,264.00
WC8000400	4	5.5	730	160M	114	9.87	42mm k6	\$4,649.00		\$5,066.00
WC8000550	5.5	7.5	725	160M	123	12.5	42mm k6	\$5,919.00		\$6,453.00
WC8000750	7.5	10	731	160L	145	18	42mm k6	\$6,394.00		\$6,971.00
WC8001100	11	15	730	180L	185	23.3	48mm k6	\$8,942.00		\$9,747.00
WC8001500	15	20	730	200L	220	32.5	55mm m6	\$11,261.00		\$12,274.00
WC8001850	18.5	25	735	225S/M	377	36.5	60mm m6	\$18,996.00		\$20,702.00
WC8002200	22	30	735	225S/M	402	44.3	60mm m6	\$20,672.00		\$22,533.00
WC8003000	30	40	730	250S/M	490	57	70mm m6	\$22,063.00		\$24,050.00
WC8003700	37	50	730	250S/M	550	73.5	70mm m6	POA		POA
WC8004500	45	60	740	280S/M	720	89	80mm m6	POA		POA
WC8005500	55	75	740	280S/M	812	111	80mm m6	POA		POA
WC8007500	75	100	740	315S/M	1025	145	85mm m6	POA		POA
WC8009000	90	125	742	315S/M	1100	173	85mm m6	POA		POA
WC8011000	110	150	745	355M/L	1450	214	100mm m6	POA		POA
WC8011000	132	175	745	355M/L	1587	256	100mm m6	POA		POA
WC8013200	150	200	744	355M/L	1540	295	100mm m6	POA		POA
WC8015000	185	250	745	355M/L	1819	361	100mm m6	POA		POA
WC8018500	220	300	744	355M/L	2020	433	100mm m6	POA		POA

W22 INCREASED SAFETY Ex ec (Zone 2)

WEG Increased Safety Exec motors are designed to prevent the occurrence during normal operating and certain specific abnormal conditions of arcs, sparks and excessive overheating of all inner and outer surfaces.



Range 0.12kW to 500kW



2, 4, 6 and 8 Pole



Improved Thermal Performance



IECEX Certification



Highly Reliable



Electrical:

- Class "H" insulation ("B" Temperature Rise: 80 K)
- Ambient temperature: 40 °C 1000 at masl
- Voltages: 220-240/380-415 V - 50 Hz (up to frame 100L) 380-415/660 V - 50 Hz (frame 112M and above)//440-460 V- 60 Hz
- Service Factor (SF): 1.00
- Design: N
- Continuous duty: S1
- Terminal block (6 pins) - (63 up to 100 - Type K1M5 and 355A/B Type HGF Line)
- Thermistors 140 °C (1/phase) all frames
- Dip and baked impregnation (frames 63 up to 200) Resin continuous flow impregnation (frames 225S/M up to 315S/M)

Mechanical:

- Squirrel cage rotor (Aluminium die Cast)
- Enclosure: TEFC (Totally Enclosed Fan Cooled)
- Mounting: B3R(E)
- WSeal (frame 225 and up), Oil Seal Double Lips (frame 63 up to 200)
- Grease nipple system in frame 160 and above
- Metric threaded cable entries
- Solid and Integrated Feet
- Ball bearings
- Shaft material: AISI 1045 (up to frame 315S/M) and AISI 4140 (315L - 355M/L)
- Conductive plastic fan and aluminium fan for 355M/L (2 poles) and 315L, 355M/L and 355A/B (4 poles and up)

Nameplate Marking: Ex ec IIC T3 or T4 Gc

Certification Number: IECEx Bas 10.0099X



2 POLE

3000 RPM Three Phase Cast Iron Frame TEFC, W22 High Efficiency "E3" Ex ec (Zone 2) IP66

Ex ec IIC T3 or T4 Gc with IECEx Certification Multivoltage 380 - 415 Volt 50HZ, 63 to 355 Frame Class "H" Insulation

160 to 200 Frame 1 x PTC Thermistor per Phase, 225 to 355 Frame 2 x PTC Thermistors per Phase

160 Frame & Above Fitted with Grease Nipple & Grease Release Valve

PART NUMBER	KW	HP	RPM	FRAME	WEIGHT KG	FLC AMPS	SHAFT SIZE	TRADE PRICE		
								B3 FOOT	B14, B5, V1 FLANGE ONLY	B34, B35 FT & FLANGE
WN2000012	0.12	0.16	2820	63	7	0.375	11mm j6	\$699.00		\$762.00
WN2000018	0.18	0.25	2860	63	8	0.533	11mm j6	\$699.00		\$762.00
WN2000025	0.25	0.33	2805	63	7.9	0.672	11mm j6	\$741.00		\$808.00
WN2000037	0.37	0.5	2820	71	10.5	0.851	14mm j6	\$853.00	\$885.00	\$926.00
WN2000055	0.55	0.75	2830	71	11	1.19	14mm j6	\$853.00	\$885.00	\$926.00
WN2000075	0.75	1	2860	80	14.1	1.65	19mm j6	\$1,058.00	\$1,098.00	\$1,151.00
WN2000110	1.1	1.5	2835	80	15	2.39	19mm j6	\$1,155.00	\$1,201.00	\$1,259.00
WN2000150	1.5	2	2885	90S	21.5	3.17	24mm j6	\$1,298.00	\$1,349.00	\$1,417.00
WN2000220	2.2	3	2870	90L	24.5	4.43	24mm j6	\$1,457.00	\$1,515.00	\$1,588.00
WN2000300	3	4	2900	100L	35	5.78	28mm j6	\$1,942.00	\$2,018.00	\$2,114.00
WN2000400R	4	5.5	2900	100L	37	7.82	28mm j6	\$2,192.00	\$2,281.00	\$2,391.00
WN2000400	4	5.5	2900	112M	41	7.59	28mm j6	\$2,265.00	\$2,356.00	\$2,469.00
WN2000550R	5.5	7.5	2880	112M	46	10.5	28mm j6	\$2,771.00	\$2,880.00	\$3,020.00
WN2000550	5.5	7.5	2940	132S	62	10.6	38mm k6	\$2,941.00	\$3,059.00	\$3,206.00
WN2000750	7.5	10	2925	132S	70	14.1	38mm k6	\$3,302.00	\$3,435.00	\$3,598.00
WN2001100R	11	15	2925	132M	84	19.6	38mm k6	\$5,026.00	\$5,228.00	\$5,479.00
WN2001100	11	15	2950	160M	115	20.4	42mm k6	\$5,088.00	\$5,292.00	\$5,547.00
WN2001500	15	20	2945	160M	120	27.7	42mm k6	\$6,041.00	\$6,283.00	\$6,585.00
WN2001850	18.5	25	2945	160L	135	33.9	42mm k6	\$7,145.00	\$7,429.00	\$7,785.00
WN2002200	22	30	2960	180M	170	39.8	48mm k6	\$8,922.00	\$9,279.00	\$9,725.00
WN2003000	30	40	2965	200L	235	54.5	55mm m6	\$11,021.00		\$12,011.00
WN2003700	37	50	2960	200L	250	67.8	55mm m6	POA		POA
WN2004500	45	60	2960	225S/M	380	77.5	55mm m6	POA		POA
WN2005500	55	75	2965	250S/M	460	97.8	60mm m6	POA		POA
WN2007500	75	100	2965	250S/M	500	128	60mm m6	POA		POA
WN2009000	90	125	2976	280S/M	710	153	65mm m6	POA		POA
WN2011000	110	150	2976	280S/M	790	187	65mm m6	POA		POA
WN2013200	132	175	2980	315S/M	950	224	65mm m6	POA		POA
WN2015000	150	200	2979	315S/M	1050	254	65mm m6	POA		POA
WN2018500	185	250	2978	315S/M	1110	317	65mm m6	POA		POA
WN2020000	200	270	2975	315S/M	1200	334	65mm m6	POA		POA
WN2022000	220	300	2985	355M/L	1600	363	75mm m6	POA		POA
WN2025000	250	340	2984	355M/L	1750	413	75mm m6	POA		POA
WN2028000	280	380	2985	355M/L	1800	468	75mm m6	POA		POA
WN2031500	315	430	2983	355M/L	1950	520	75mm m6	POA		POA



4 POLE

1500 RPM Three Phase Cast Iron Frame TEFC, W22 High Efficiency "E3" Ex ec (Zone 2) IP66

Ex ec IIC T3 or T4 Gc with IECEx Certification Multivoltage 380 - 415 Volt 50HZ, 63 to 355 Frame Class "H" Insulation

160 to 200 Frame 1 x PTC Thermistor per Phase, 225 to 355 Frame 2 x PTC Thermistors per Phase

160 Frame & Above Fitted with Grease Nipple & Grease Release Valve

PART NUMBER	KW	HP	RPM	FRAME	WEIGHT KG	FLC AMPS	SHAFT SIZE	TRADE PRICE		
								B3 FOOT	B14, B5, V1 FLANGE ONLY	B34, B35 FT & FLANGE
WN4000012	0.12	0.16	1370	63	7	0.366	11mm j6	\$658.00		\$718.00
WN4000018	0.18	0.25	1380	63	8	0.516	11mm j6	\$658.00	\$683.00	\$718.00
WN4000025	0.25	0.33	1410	71	8	0.682	14mm j6	\$687.00	\$717.00	\$748.00
WN4000037	0.37	0.5	1385	71	9.5	0.987	14mm j6	\$699.00	\$727.00	\$762.00
WN4000055	0.55	0.75	1425	80	12.5	1.23	19mm j6	\$842.00	\$877.00	\$920.00
WN4000075	0.75	1	1435	L80	14.5	1.68	19mm j6	\$971.00	\$1,008.00	\$1,059.00
WN4000110	1.1	1.5	1445	90S	19.5	2.35	24mm j6	\$1,182.00	\$1,230.00	\$1,287.00
WN4000150	1.5	2	1445	90L	23	3.21	24mm j6	\$1,327.00	\$1,381.00	\$1,446.00
WN4000220	2.2	3	1435	100L	31.5	4.62	28mm j6	\$1,631.00	\$1,695.00	\$1,779.00
WN4000300	3	4	1440	L100L	37.5	6.15	28mm j6	\$1,890.00	\$1,968.00	\$2,061.00
WN4000400	4	5.5	1450	112M	44	8.34	28mm j6	\$2,358.00	\$2,453.00	\$2,570.00
WN4000550	5.5	7.5	1465	132S	66	10.5	38mm k6	\$3,062.00	\$3,183.00	\$3,335.00
WN4000750	7.5	10	1460	132M	74	14.2	38mm k6	\$3,610.00	\$3,754.00	\$3,933.00
WN4000920	9.2	12.5	1465	132M/L	82	17.8	38mm k6	\$4,541.00		\$4,949.00
WN4001100	11	15	1475	160M	113	20.9	42mm k6	\$5,244.00	\$5,457.00	\$5,718.00
WN4001500	15	20	1470	160L	140	28.3	42mm k6	\$5,993.00		\$6,532.00
WN4001850	18.5	25	1470	180M	188	35.2	48mm k6	\$8,141.00		\$8,872.00
WN4002200	22	30	1470	180L	185	41	48mm k6	\$9,087.00		\$9,906.00
WN4003000	30	40	1480	200L	228	57.1	55mm m6	\$11,297.00		\$12,311.00
WN4003700	37	50	1480	225S/M	365	69.2	60mm m6	POA		POA
WN4004500	45	60	1480	225S/M	400	81.9	60mm m6	POA		POA
WN4005500	55	75	1480	250S/M	500	98.6	70mm m6	POA		POA
WN4007500	75	100	1480	250S/M	530	131	70mm m6	POA		POA
WN4009000	90	125	1485	280S/M	700	160	80mm m6	POA		POA
WN4011000	110	150	1485	280S/M	800	195	80mm m6	POA		POA
WN4013200	132	175	1490	315S/M	1010	231	85mm m6	POA		POA
WN4015000	150	200	1490	315S/M	1030	266	85mm m6	POA		POA
WN4018500	185	250	1491	315S/M	1150	327	85mm m6	POA		POA
WN4020000	200	270	1488	315S/M	1250	346	85mm m6	POA		POA
WN4022000	220	300	1492	355M/L	1510	393	100mm m6	POA		POA
WN4025000	250	340	1490	355M/L	1555	436	100mm m6	POA		POA
WN4028000	280	380	1490	355M/L	1600	488	100mm m6	POA		POA
WN4030000	300	400	1490	355M/L	1650	530	100mm m6	POA		POA
WN4031500	315	430	1491	355M/L	1750	562	100mm m6	POA		POA
WN4033000	330	450	1490	355M/L	1810	583	100mm m6	POA		POA
WN4035500	355	480	1490	355M/L	1878	618	100mm m6	POA		POA



6 POLE

1000 RPM Three Phase Cast Iron Frame TEFC, W22 High Efficiency "E3" Ex ec (Zone 2) IP66

Ex ec IIC T3 or T4 Gc with IECEx Certification Multivoltage 380 - 415 Volt 50HZ, 63 to 355 Frame Class "H" Insulation

160 to 200 Frame 1 x PTC Thermistor per Phase, 225 to 355 Frame 2 x PTC Thermistors per Phase

160 Frame & Above Fitted with Grease Nipple & Grease Release Valve

PART NUMBER	KW	HP	RPM	FRAME	WEIGHT KG	FLC AMPS	SHAFT SIZE	TRADE PRICE		
								B3 FOOT	B14, B5, V1 FLANGE ONLY	B34, B35 FT & FLANGE
WN6000025	0.25	0.33	890	71	12	0.76	14mm j6	\$941.00		\$1,026.00
WN6000037	0.37	0.5	925	80	12.5	0.969	19mm j6	\$957.00		\$1,043.00
WN6000055	0.55	0.75	945	L80	15.5	1.49	19mm j6	\$1,093.00		\$1,189.00
WN6000075	0.75	1	950	L90S	22	1.93	24mm j6	\$1,283.00		\$1,398.00
WN6000110	1.1	1.5	935	90L	25.3	2.78	24mm j6	\$1,510.00		\$1,646.00
WN6000150	1.5	2	955	100L	32	3.7	28mm j6	\$1,779.00		\$1,940.00
WN6000220	2.2	3	960	112M	46	5.29	28mm j6	\$2,123.00		\$2,313.00
WN6000300	3	4	970	132S	65	6.93	38mm k6	\$3,108.00		\$3,389.00
WN6000400	4	5.5	965	132M	70	9.11	38mm k6	\$3,545.00		\$3,864.00
WN6000550	5.5	7.5	970	132M/L	78	12.9	38mm k6	\$4,153.00		\$4,527.00
WN6000750	7.5	10	975	160M	118	15.2	42mm k6	\$4,857.00		\$5,295.00
WN6001100	11	15	978	160L	140	22.8	42mm k6	\$6,758.00		\$7,366.00
WN6001500	15	20	977	180L	185	28.2	48mm k6	\$8,840.00		\$9,633.00
WN6001850	18.5	25	980	200L	215	35.9	55mm m6	\$11,616.00		\$12,661.00
WN6002200	22	30	980	200L	225	42.4	55mm m6	\$13,868.00		\$15,115.00
WN6003000	30	40	980	225S/M	380	56	60mm m6	\$18,680.00		\$20,363.00
WN6003700	37	50	985	250S/M	430	67.2	70mm m6	POA		POA
WN6004500	45	60	985	250S/M	490	79.5	70mm m6	POA		POA
WN6005500	55	75	988	280S/M	665	103	80mm m6	POA		POA
WN6007500	75	100	990	280S/M	725	141	80mm m6	POA		POA
WN6009000	90	125	990	315S/M	990	165	85mm m6	POA		POA
WN6011000	110	150	990	315S/M	1040	201	85mm m6	POA		POA
WN6013200	132	175	992	315S/M	1100	243	85mm m6	POA		POA
WN6015000	150	200	993	355M/L	1440	283	100mm m6	POA		POA
WN6018500	185	250	994	355M/L	1550	362	100mm m6	POA		POA
WN6022000	220	300	994	355M/L	1710	419	100mm m6	POA		POA
WN6025000	250	340	993	355M/L	1830	476	100mm m6	POA		POA
WN6030000	300	400	992	355M/L	2493	564	100mm m6	POA		POA



8 POLE

750 RPM Three Phase Cast Iron Frame TEFC, W22 High Efficiency "E3" Ex ec (Zone 2) IP66

Ex ec IIC T3 or T4 Gc with IECEx Certification Multivoltage 380 - 415 Volt 50HZ, 63 to 355 Frame Class "H" Insulation

160 to 200 Frame 1 x PTC Thermistor per Phase, 225 to 355 Frame 2 x PTC Thermistors per Phase

160 Frame & Above Fitted with Grease Nipple & Grease Release Valve

PART NUMBER	KW	HP	RPM	FRAME	WEIGHT KG	FLC AMPS	SHAFT SIZE	TRADE PRICE		
								B3 FOOT	B14, B5, V1 FLANGE ONLY	B34, B35 FT & FLANGE
WN8000025	0.25	0.33	695	80	14.5	0.894	19mmj6	\$1,311.00		\$1,430.00
WN8000037	0.37	0.5	700	90S	19	1.24	24mm j6	\$1,351.00		\$1,473.00
WN8000055	0.55	0.75	695	90L	23	1.62	24mm j6	\$1,462.00		\$1,592.00
WN8000075	0.75	1	710	100L	30.5	2.31	28mm j6	\$1,915.00		\$2,089.00
WN8000110	1.1	1.5	710	100L	33	3.3	28mm j6	\$2,151.00		\$2,343.00
WN8000150	1.5	2	705	112M	43	3.98	28mm j6	\$2,424.00		\$2,644.00
WN8000220	2.2	3	710	132S	69	5.37	38mm k6	\$3,364.00		\$3,666.00
WN8000300	3	4	710	132M	75	7.2	38mm k6	\$3,909.00		\$4,264.00
WN8000400	4	5.5	730	160M	114	9.87	42mm k6	\$4,649.00		\$5,066.00
WN8000550	5.5	7.5	725	160M	123	12.5	42mm k6	\$5,919.00		\$6,453.00
WN8000750	7.5	10	731	160L	145	18	42mm k6	\$6,394.00		\$6,971.00
WN8001100	11	15	730	180L	185	23.3	48mm k6	\$8,942.00		\$9,747.00
WN8001500	15	20	730	200L	220	32.5	55mm m6	\$11,261.00		\$12,274.00
WN8001850	18.5	25	735	225S/M	377	36.5	60mm m6	\$18,996.00		\$20,702.00
WN8002200	22	30	735	225S/M	402	44.3	60mm m6	\$20,672.00		\$22,533.00
WN8003000	30	40	730	250S/M	490	57	70mm m6	\$22,063.00		\$24,050.00
WN8003700	37	50	730	250S/M	550	73.5	70mm m6	POA		POA
WN8004500	45	60	740	280S/M	720	89	80mm m6	POA		POA
WN8005500	55	75	740	280S/M	812	111	80mm m6	POA		POA
WN8007500	75	100	740	315S/M	1025	145	85mm m6	POA		POA
WN8009000	90	125	742	315S/M	1100	173	85mm m6	POA		POA
WN8011000	110	150	745	355M/L	1450	214	100mm m6	POA		POA
WN8011000	132	175	745	355M/L	1587	256	100mm m6	POA		POA
WN8013200	150	200	744	355M/L	1540	295	100mm m6	POA		POA
WN8015000	185	250	745	355M/L	1819	361	100mm m6	POA		POA
WN8018500	220	300	744	355M/L	2020	433	100mm m6	POA		POA

W21 EXPLOSION PROOF Ex d - (ZONE 1)

Explosion proof motors are designed to maintain the safety of your plant in hazardous areas.



Range 0.37kW to 315kW



2, 4, 6 and 8 Pole



ANZEX Certified



MEPS Compliant



Electrical:

- Class "F" insulation ("B" Temperature Rise: 80 K)
- Ambient temperature: 40 °C at 1000 masl
- Temperature class T4
- Voltages: 220-240/380-415 V (up to 100L) and 380-415/660 V (from 112M and up) - 50 Hz
- Service Factor (SF): 1.00
- Design: N
- Continuous duty: S1
- Terminal block (6 pins) for Ex d motors;
- 2x Thermistors (1/phase) 130 °C and 155 °C
- Space heater (200 – 240Volts)
- Dip and baked impregnation (frames 90 up to 200) Resin continuous flow impregnation (frames 225S/M up to 355M/L)

Mechanical:

- Squirrel cage rotor (Aluminium die Cast)
- Enclosure: TEFC (Totally Enclosed Fan Cooled)
- Degree of protection: IP55 · Mounting: B3R(E)
- Lip seal up to frame 355M/L (Only to 4 Poles and up) Labyrinth seal frame 315S/M and 355M/L (Only to Enclosure IP56/IPW56/IP65/IPW65/IP66/IPW66)
- Grease nipple system in frame 225S/M and above
- Shaft material: AISI 1045 steel (90S up to 250S/M) and AISI 4140 (280S/M up to 355M/L - 4 poles and above)
- Metric thread cable entries · Cast iron fan

Classification: Ex d I/II B T4

Certification: ANZEx 04.3006X



2 POLE

WEG Squirrel Cage Induction Motors, Totally Enclosed Fan Cooled

Cast Iron Construction, IP55, Class "F" Insulation

EEX d Groups 1, IIA AND IIB, T4, Class 1, Zone 1

ANZEx Scheme Compliant - Test Safe Australia Certificate # ANZEx 04.3006X

Designed as suitable for use with Variable Frequency Speed Control

Thermistors Two per Phase

Anti-Condensation Heaters

Supply 400 Volt 50HZ

PART NUMBER	KW	HP	RPM	FRAME	WEIGHT KG	FLC AMPS	SHAFT SIZE	TRADE PRICE		
								B3 FOOT	B14 or B5 FLANGE ONLY	B34 OR B35 FT & FLANGE
E2000037B3	0.37	0.5	2870	90S	23	1	24mm j6	\$2,038.00		\$2,221.00
E2000055B3	0.55	0.75	2830	90S	24	1.3	24mm j6	\$2,065.00		\$2,250.00
E2000075B3	0.75	1	2890	90S	25	1.6	24mm j6	\$2,420.00		\$2,640.00
E2000110B3	1.1	1.5	2880	90S	26	2.3	24mm j6	\$2,707.00		\$2,952.00
E2000150B3	1.5	2	2865	90S	29	2.9	24mm j6	\$2,721.00		\$2,967.00
E2000220B3	2.2	3	2870	100L	36	4.5	28mm j6	\$3,314.00		\$3,613.00
E2000300B3	3	4	2930	100L	44	5.5	28mm j6	\$3,422.00		\$3,729.00
E2000400B3	4	5.5	2910	112M	56	7.5	28mm j6	\$4,214.00		\$4,594.00
E2000550B3	5.5	7.5	2930	132S	84	10	38mm k6	\$4,939.00		\$5,384.00
E2000750B3	7.5	10	2930	132S	91	13	38mm k6	\$5,339.00		\$5,820.00
E2001100B3	11	15	2930	160M	112	19	42mm k6	\$7,276.00		\$7,933.00
E2001500B3	15	20	2920	160M	130	25	42mm k6	\$8,317.00		\$9,066.00
E2001850B3	18.5	25	2930	160L	160	30	42mm k6	\$8,450.00		\$9,210.00
E2002200B3	22	30	2960	180M	206	36	48mm k6	\$11,701.00		\$12,753.00
E2003000B3	30	40	2960	200L	270	49	55mm m6	\$14,812.00		\$16,144.00
E2003700B3	37	50	2970	200L	288	62	55mm m6	POA		POA
E2004500B3	45	60	2960	225S/M	455	73	55mm m6	POA		POA
E2005500B3	55	75	2970	250S/M	490	88	60mm m6	POA		POA
E2007500B3	75	100	2980	250S/M	530	131	60mm m6	POA		POA
E2009000B3	90	125	2960	280S/M	790	145	65mm m6	POA		POA
E2011000B3	110	150	2970	280S/M	950	185	65mm m6	POA		POA
E2013000B3	130	175	2950	315S/M	970	219	65mm m6	POA		POA
E2016000B3	160	220	2950	315S/M	1230	268	65mm m6	POA		POA
E2018500B3	185	250	2950	315S/M	1230	341	65mm m6	POA		POA
E2020000B3	200	270	2970	355M/L	1500	416	75mm m6	POA		POA
E2022000B3	220	300	2970	355M/L	1800	416	75mm m6	POA		POA



4 POLE WEG Squirrel Cage Induction Motors, Totally Enclosed Fan Cooled

Cast Iron Construction, IP55, Class "F" Insulation

EEX d Groups 1, IIA AND IIB, T4, Class 1, Zone 1

ANZEx Scheme Compliant - Test Safe Australia Certificate # ANZEx 04.3006X

Designed as suitable for use with Variable Frequency Speed Control

Thermistors Two per Phase

Anti-Condensation Heaters

Supply 400 Volt 50HZ

PART NUMBER	KW	HP	RPM	FRAME	WEIGHT KG	FLC AMPS	SHAFT SIZE	TRADE PRICE		
								B3 FOOT	B14 or B5 FLANGE ONLY	B34 OR B35 FT & FLANGE
E4000037B3	0.37	0.5	1410	90S	25	1	24mm j6	\$2,076.00		\$2,263.00
E4000055B3	0.55	0.75	1430	90S	25	1.6	24mm j6	\$2,092.00		\$2,281.00
E4000075B3	0.75	1	1430	90L	27	1.9	24mm j6	\$2,528.00		\$2,756.00
E4000110B3	1.1	1.5	1430	90L	27	2.7	24mm j6	\$2,632.00		\$2,871.00
E4000150B3	1.5	2	1410	100L	35	3.1	28mm j6	\$2,993.00		\$3,265.00
E4000220B3	2.2	3	1430	100L	41	4.6	28mm j6	\$3,293.00		\$3,590.00
E4000300B3	3	4	1430	112M	44	6.2	28mm j6	\$3,745.00		\$4,084.00
TEXD-19-4	4	5.5	1440	112M	45	8	28mm j6	\$4,214.00		\$4,594.00
E4000550B3	5.5	7.5	1450	132S	78	10	38mm k6	\$5,390.00		\$5,878.00
E4000750B3	7.5	10	1450	132M	95	14	38mm k6	\$5,889.00		\$6,417.00
E4001100B3	11	15	1450	160M	126	20	42mm k6	\$7,841.00		\$8,547.00
E4001500B3	15	20	1460	160L	170	27	42mm k6	\$8,909.00		\$9,710.00
E4001850B3	18.5	25	1460	180M	210	33	48mm k6	\$11,610.00		\$12,654.00
E4002200B3	22	30	1470	180L	240	39	48mm k6	\$12,457.00		\$13,578.00
E4003000B3	30	40	1460	200L	290	52	55mm m6	\$15,713.00		\$17,127.00
E4003700B3	37	50	1470	225S/M	415	63	60mm m6	POA		POA
E4004500B3	45	60	1470	225S/M	455	75	60mm m6	POA		POA
E4005500B3	55	75	1480	250S/M	490	92	70mm m6	POA		POA
E4007500B3	75	100	1470	280S/M	520	126	80mm m6	POA		POA
E4009200B3	90	125	1480	280S/M	830	152	80mm m6	POA		POA
E4011000B3	110	150	1480	280S/M	910	194	80mm m6	POA		POA
E4013000B3	130	175	1480	315S/M	1025	229	85mm m6	POA		POA
E4016000B3	160	220	1480	315S/M	1170	292	85mm m6	POA		POA
E4018500B3	185	250	1480	315S/M	1210	320	85mm m6	POA		POA
E4020000B3	200	270	1480	355M/L	1350	341	100mm m6	POA		POA
E4022000B3	220	300	1480	355M/L	1490	370	100mm m6	POA		POA
E4025000B3	250	350	1490	355M/L	1490	421	100mm m6	POA		POA
E4030000B3	300	400	1490	355M/L	1630	505	100mm m6	POA		POA
E4031500B3	315	430	1490	355M/L	1630	529	100mm m6	POA		POA



6 POLE

WEG Squirrel Cage Induction Motors, Totally Enclosed Fan Cooled

Cast Iron Construction, IP55, Class "F" Insulation

EEX d Groups 1, IIA AND IIB, T4, Class 1, Zone 1

ANZEx Scheme Compliant - Test Safe Australia Certificate # ANZEx 04.3006X

Designed as suitable for use with Variable Frequency Speed Control

Thermistors Two per Phase

Anti-Condensation Heaters

Supply 400 Volt 50HZ

PART NUMBER	KW	HP	RPM	FRAME	WEIGHT KG	FLC AMPS	SHAFT SIZE	TRADE PRICE		
								B3 FOOT	B14 or B5 FLANGE ONLY	B34 OR B35 FT & FLANGE
E6000037B3	0.37	0.5	910	90S	25	0.82	24mm j6	\$2,065.00		\$2,250.00
E6000055B3	0.55	0.75	920	90L	30	1.2	24mm j6	\$2,170.00		\$2,368.00
E6000075B3	0.75	1	950	90L	30	2.1	24mm j6	\$2,602.00		\$2,834.00
E6000110B3	1.1	1.5	950	90L	32	2.8	24mm j6	\$3,103.00		\$3,381.00
E6000150B3	1.5	2	950	100L	41	3.6	28mm j6	\$3,260.00		\$3,554.00
E6000220B3	2.2	3	950	112M	60	4.7	28mm j6	\$3,707.00		\$4,042.00
E6000300B3	3	4	950	132S	73	6.2	38mm k6	\$4,875.00		\$5,314.00
E6000400B3	4	5.5	950	132M	85	8	38mm k6	\$5,377.00		\$5,859.00
E6000550B3	5.5	7.5	960	132M	105	11	38mm k6	\$6,266.00		\$6,830.00
E6000750B3	7.5	10	970	160M	137	14	42mm k6	\$7,865.00		\$8,570.00
E6001100B3	11	15	960	160L	185	20	42mm k6	\$9,020.00		\$9,830.00
E6001500B3	15	20	970	180L	215	25	48mm k6	\$12,213.00		\$13,312.00
E6001850B3	18.5	25	980	200L	245	32	55mm m6	\$15,195.00		\$16,563.00
E6002200B3	22	30	980	200L	267	38	55mm m6	\$16,021.00		\$17,464.00
E6003000B3	30	40	980	225S/M	440	54	60mm m6	\$23,039.00		\$25,111.00
E6003700B3	37	50	980	250S/M	515	65	70mm m6	POA		POA
E6004500B3	45	60	980	280S/M	595	77	80mm m6	POA		POA
E6005500B3	55	75	990	280S/M	770	98	80mm m6	POA		POA
E6007500B3	75	100	980	280S/M	800	133	80mm m6	POA		POA
E6009000B3	90	125	980	315S/M	1060	159	85mm m6	POA		POA
E6011000B3	110	150	990	315S/M	1260	190	85mm m6	POA		POA
E6013000B3	130	175	990	355M/L	1620	243	100mm m6	POA		POA
E6016000B3	160	220	990	355M/L	1620	310	100mm m6	POA		POA
E6018500B3	185	250	990	355M/L	1780	310	100mm m6	POA		POA
E6020000B3	200	270	990	355M/L	1780	385	100mm m6	POA		POA
E6025000B3	250	350	990	355M/L	1880	470	100mm m6	POA		POA



8 POLE

WEG Squirrel Cage Induction Motors, Totally Enclosed Fan Cooled

Cast Iron Construction, IP55, Class "F" Insulation

EEX d Groups 1, IIA AND IIB, T4, Class 1, Zone 1

ANZEx Scheme Compliant - Test Safe Australia Certificate # ANZEx 04.3006X

Designed as suitable for use with Variable Frequency Speed Control

Thermistors Two per Phase

Anti-Condensation Heaters

Supply 400 Volt 50HZ

PART NUMBER	KW	HP	RPM	FRAME	WEIGHT KG	FLC AMPS	SHAFT SIZE	TRADE PRICE		
								B3 FOOT	B14 or B5 FLANGE ONLY	B34 OR B35 FT & FLANGE
E8000037B3	0.37	0.5	700	90L	30	1.3	24mm j6	\$2,251.00		\$2,455.00
E8000055B3	0.55	0.75	700	90L	34	1.5	24mm j6	\$2,265.00		\$2,469.00
E8000075B3	0.75	1	700	100L	41	2	28mm j6	\$3,160.00		\$3,446.00
E8000110B3	1.1	1.5	700	100L	45	3	28mm j6	\$3,752.00		\$4,088.00
E8000150B3	1.5	2	700	112M	68	3.3	28mm j6	\$4,402.00		\$4,798.00
E8000220B3	2.2	3	720	132S	93	5.3	38mm k6	\$4,917.00		\$5,360.00
E8000300B3	3	4	720	132M	105	6.6	38mm k6	\$5,152.00		\$5,616.00
E8000400B3	4	5.5	720	160M	137	10	42mm k6	\$6,873.00		\$7,492.00
E8000550B3	5.5	7.5	730	160M	144	13	42mm k6	\$7,198.00		\$7,846.00
E8000750B3	7.5	10	720	160L	172	17	42mm k6	\$8,295.00		\$9,042.00
E8001100B3	11	15	730	180L	228	23	48mm k6	\$10,310.00		\$11,236.00
E8001500B3	15	20	730	200L	250	30	55mm m6	\$12,888.00		\$14,048.00
E8001850B3	18.5	25	740	225S/M	415	34	60mm m6	\$21,525.00		\$23,462.00
E8002200B3	22	30	740	225S/M	442	43	60mm m6	\$23,812.00		\$25,955.00
E8003000B3	30	40	730	250S/M	523	53	70mm m6	\$25,244.00		\$27,516.00
E8003700B3	37	50	730	280S/M	590	70	80mm m6	POA		POA
E8004500B3	45	60	730	280S/M	765	86	80mm m6	POA		POA
E8005500B3	55	75	740	280S/M	820	100	80mm m6	POA		POA
E8007500B3	75	100	730	315S/M	1018	132	85mm m6	POA		POA
E8009000B3	90	125	730	315S/M	1132	165	85mm m6	POA		POA
E8011000B3	110	150	730	355M/L	1390	210	100mm m6	POA		POA
E8013200B3	132	175	730	355M/L	1520	248	100mm m6	POA		POA
E8016000B3	160	220	730	355M/L	1710	300	100mm m6	POA		POA
E8018500B3	185	250	730	355M/L	1820	384	100mm m6	POA		POA
E8020000B3	200	260	730	355M/L	1820	384	100mm m6	POA		POA

W22 IEC CAST IRON

Single-Phase motor with cast iron frame. Ideal for many different applications, such as fans, compressors, pumps, cranes, among other general applications.



Range 0.25kW to 7.5kW



2 and 4 poles



Electrical:

- Class "F" insulation ("B" Temperature Rise: 80 K) **Unless otherwise indicated at FDC**
- Ambient temperature: 40 °C 1000 at masl
- Voltages: 230/460 V - 50 Hz
- Service Factor (SF): 1.00
- Design: N
- Continuous duty: S1
- Terminal block (6 pins)
- Dip and baked impregnation (frames 63 up to 132)

Mechanical:

- Squirrel cage rotor (Aluminium die Cast)
- Enclosure: TEFC (Totally Enclosed Fan Cooled)
- Mounting: B3T
- V'ring seals
- Ball bearings
- Shaft material: AISI 1040/45 steel
- Automatic drain plug
- Metric thread cable entries



2 POLE

3000 RPM SINGLE PHASE IEC FRAME IP55 TEFC

CLASS "F" INSULATION 230 VOLT 50HZ COMPLETE WITH MANUAL RESET THERMAL OVERLOAD

PART NUMBER	KW	HP	RPM	FRAME	WEIGHT KG	FLC AMPS	SHAFT SIZE	TRADE PRICE		
								B3 FOOT	B5 FLANGE ONLY	B34, B35 FT & FLANGE
WL2000150	1.5	2	2900	90S	24	8.67	24mm j6	\$890.00		\$972.00
WL2000220	2.2	3	2895	90L	27	12.5	24mm j6	\$1,036.00		\$1,132.00
WL2000300	3	4	2895	100L	40	16.8	28mm j6	\$1,328.00		\$1,449.00

4 POLE

1500 RPM SINGLE PHASE IEC FRAME IP55 TEFC

CLASS "F" INSULATION 230 VOLT 50HZ COMPLETE WITH MANUAL RESET THERMAL OVERLOAD

PART NUMBER	KW	HP	RPM	FRAME	WEIGHT KG	FLC AMPS	SHAFT SIZE	TRADE PRICE		
								B3 FOOT	B5 FLANGE ONLY	B34, B35 FT & FLANGE
WL4000037	0.37	0.5	1440	71	12	2.87	14mm j6	\$597.00		\$651.00
WL4000055	0.55	0.75	1450	80	16	4.2	19mm j6	\$611.00		\$668.00
WL4000075	0.75	1	1450	80	16.5	5.26	19mm j6	\$650.00		\$707.00
WL4000110	1.1	1.5	1430	90S	19	7.32	24mm j6	\$720.00		\$784.00
WL4000150	1.5	2	1440	90L	29	10.42	24mm j6	\$953.00		\$1,039.00
WL4000220	2.2	3	1450	100L	34	14.17	28mm j6	\$1,125.00		\$1,226.00

W01 NEMA FRAME (IP21)

The W01 motor is the perfect option for applications that require robustness, low weight, and high performance in a single product. The W01 Rolled Steel Single Phase motor has good thermal performance and easy installation and maintenance. Because of their high starting torque, they are particularly well-suited for heavy starting loads.



Range 0.18kW to 2.2kW



2 and 4 poles



Electrical:

- Class "F" insulation ("B" Temperature Rise: 80 K) **Unless otherwise indicated**
- Ambient temperature: 40 °C 1000 at masl
- Voltages: 230 V - 50 Hz
- Service Factor (SF): 1.00
- Design: N
- Continuous duty: S1
- Dip and baked impregnation

Mechanical:

- Squirrel cage rotor (Aluminium die Cast)
- Enclosure: ODP (Open Drip Proof)
- Mounting: B3R(E)
- V'ring seals
- Ball bearings
- Shaft material: AISI 1040/45 steel
- Automatic drain plug
- Metric thread cable entries



COMPRESSOR RATED SINGLE PHASE

2 POLE DESIGNED TO SUIT BELT DRIVE COMPRESSORS UP TO 16CFM.

HIGH TORQUE CAPACITOR START & RUN. MANUAL RESET THERMAL OVERLOAD PROTECTION.

HIGH EFFICIENCY & POWER FACTOR FOR LOWER RUNNING COSTS.

240 VOLTS 50HZ CLASS "F" INSULATION.

OPEN DRIP PROOF (IP21) IN ACCORDANCE WITH AS1359.

PART NUMBER	KW	HP	RPM	FRAME	WEIGHT KG	FLC AMPS	SHAFT SIZE	TRADE PRICE		
								B3 FOOT	B5 FLANGE ONLY	B34, B35 FT & FLANGE
U2000170C	1.7	2.2	2900	56H	20	10	19.05	\$521.00		
U2000220C	2.2	3	2880	56H	21	14	19.05	\$623.00		

STANDARD NEMA FRAME SINGLE PHASE

4 POLE 1500 RPM SINGLE PHASE NEMA 56 FRAME IP21 DRIPPROOF

CLASS "F" INSULATION 230 VOLT 50HZ COMPLETE WITH MANUAL RESET

THERMAL OVERLOAD & 1.5 METRES OF FLEX

PART NUMBER	KW	HP	RPM	FRAME	WEIGHT KG	FLC AMPS	SHAFT SIZE	TRADE PRICE		
								B3 FOOT	B5 FLANGE ONLY	B34, B35 FT & FLANGE
U4000018	0.18	<i>0.25</i>	1430	W56	9	2.3	15.87mm	\$308.00		
U4000025	0.25	<i>0.33</i>	1430	W56	10	3.1	15.87mm	\$351.00		
U4000037	0.37	<i>0.5</i>	1430	W56	11.5	4.3	15.87mm	\$376.00		

W01 NEMA FRAME (IP55)

The W01 motor is the perfect option for applications that require robustness, low weight, and high performance in a single product. The W01 Rolled Steel Single Phase motor has good thermal performance and easy installation and maintenance. Because of their high starting torque, they are particularly well-suited for heavy starting loads.



Range 0.18kW to 2.2kW



2 and 4 poles



Electrical:

- Class "F" insulation ("B" Temperature Rise: 80 K) **Unless otherwise indicated**
- Ambient temperature: 40 °C 1000 at masl
- Voltages: 230 V - 50 Hz
- Service Factor (SF): 1.00
- Design: N
- Continuous duty: S1
- Dip and baked impregnation

Mechanical:

- Squirrel cage rotor (Aluminium die Cast)
- Enclosure: TEFC (Totally Enclosed Fan Cooled)
- Mounting: B3R(E)
- V'ring seals
- Ball bearings
- Shaft material: AISI 1040/45 steel
- Automatic drain plug
- Metric thread cable entries



2 POLE

3000 RPM SINGLE PHASE NEMA 56 FRAME IP55 TEFC

CLASS "F" INSULATION 230 VOLT 50HZ COMPLETE WITH MANUAL RESET
THERMAL OVERLOAD & 1.5 METRES OF FLEX

PART NUMBER	KW	HP	RPM	FRAME	WEIGHT KG	FLC AMPS	SHAFT SIZE	TRADE PRICE		
								B3 FOOT	B5 FLANGE ONLY	B34, B35 FT & FLANGE
V2000075	0.75	1	2850	56	14.6	5.3	15.87mm	\$514.00		\$561.00
V2000150	1.5	2	2900	56H	20	9.5	19.05mm	\$642.00		\$699.00

4 POLE

1500 RPM SINGLE PHASE NEMA 56 FRAME IP55 TEFC

CLASS "F" INSULATION 230 VOLT 50HZ COMPLETE WITH MANUAL RESET
THERMAL OVERLOAD & 1.5 METRES OF FLEX

PART NUMBER	KW	HP	RPM	FRAME	WEIGHT KG	FLC AMPS	SHAFT SIZE	TRADE PRICE		
								B3 FOOT	B5 FLANGE ONLY	B34, B35 FT & FLANGE
V4000018	0.18	0.25	1450	W56	10	2.2	15.87mm	\$377.00		\$413.00
V4000025	0.25	0.33	1470	W56	11	2.77	15.87mm	\$387.00		\$420.00
V4000037	0.37	0.5	1440	W56	12	3.73	15.87mm	\$462.00		\$505.00
V4000055	0.55	0.75	1450	56	13.5	4.49	15.87mm	\$496.00		\$540.00
V4000075	0.75	1	1440	56H	15	5.74	15.87mm	\$553.00		\$602.00
V4000110	1.1	1.5	1440	56H	21	7.5	19.05mm	\$705.00		\$767.00
V4000150	1.5	2	1440	56HZ	24.8	8.9	19.05mm	\$767.00		\$834.00

IEC DUAL VOLTAGE

IEC Dual Voltage motor with cast iron frame. Ideal for many different applications, such as fans, compressors, pumps, cranes, among other general applications.



Range 1.5kW to 7.5kW



2 and 4 poles



Electrical:

- Class "F" insulation ("B" Temperature Rise: 80 K) **Unless otherwise indicated at FDC**
- Ambient temperature: 40 °C 1000 at masl
- Voltages: Dual Voltage
- Service Factor (SF): 1.00
- Design: N
- Continuous duty: S1
- Terminal block (6 pins)
- Dip and baked impregnation (frames 100 up to 132)

Mechanical:

- Squirrel cage rotor (Aluminium die Cast)
- Enclosure: TEFC (Totally Enclosed Fan Cooled)
- Mounting: B3T
- V'ring seals
- Ball bearings
- Shaft material: AISI 1040/45 steel
- Automatic drain plug
- Metric thread cable entries



2 POLE

3000 RPM DUAL VOLTAGE CAST IRON FRAME IP55 TEFC

CLASS "B" INSULATION 230/460/400 VOLT 50HZ

PART NUMBER	KW	HP	RPM	FRAME	WEIGHT KG	FLC AMPS	SHAFT SIZE	TRADE PRICE		
								B3 FOOT	B5 FLANGE ONLY	B34 OR B35 FT & FLANGE
ME-17	3.7	5	2910	112M	49	22/11	28mm	\$1,373.00		\$1,496.00
ME-20	5.5	7.5	2970	132M	80	31.2/15.6	38mm	\$1,601.00		\$1,744.00
ME-24	7.5	10	2920	132M/L	89	40.2/20.1	38mm	\$1,775.00		\$1,934.00

4 POLE

1500 RPM DUAL VOLTAGE CAST IRON FRAME IP55 TEFC

CLASS "B" INSULATION 230/460/400 VOLT 50HZ

PART NUMBER	KW	HP	RPM	FRAME	WEIGHT KG	FLC AMPS	SHAFT SIZE	TRADE PRICE		
								B3 FOOT	B5 FLANGE ONLY	B34 OR B35 FT & FLANGE
ME-14	1.5	2	1440	90L	30	10.4/5.2	24mm	\$857.00		\$935.00
ME-16	2.2	3	1450	100L	39	14.2/7.1	28mm	\$1,243.00		\$1,355.00
ME-18	3.7	5	1430	112M	51	20/10	28mm	\$1,547.00		\$1,686.00
ME-21	5.5	7.5	1440	132M	70	30.7/15.4	38mm	\$1,849.00		\$2,016.00
ME-25	7.5	10	1440	132M/L	93	46/23	38mm	\$1,961.00		\$2,138.00

DRIVES

VARIABLE SPEED DRIVES

CFW100

CFW300

CFW500

CFW900

CFW11

SOFT STARTERS

SSW07

SSW900

CFW100

The smallest heavy-duty VSD on the market. Many simple applications at your fingertips.



Range 0.37kW to 1.1kW



230V Single Phase



IP20



Easy to Program



SoftPLC Built-In



Scalar (V/F) or Vector VVW Control

MINI DRIVE CFW100 G2



- **Sizes:** 230V single phase
0.37kW (1.6A) up to 2.2Kw (4.2A)
- Heavy Duty drive - Withstands an overload of 150% for one minute every 10 minutes
- Scalar (V/F) or Vector VVW control
- SoftPLC build-in
- Extractable fan (sizes B and C)
- Free WPS monitoring and programming software
- Flash Memory Module
Program the drive without having to power it up.
- Remote HMI (optional)
- Potentiometer Plug-In Module

PLUG-IN MODULES AND ACCESSORIES

Reference	Description	Illustrative figures
Control accessories		
CFW100-CRS485	RS485 communication module, with Modbus Master function	
CFW100-CUSB	USB communication module with 2 m cable	
CFW100-IOA	I/O expansion module with 1 analog input and 1 analog output	
CFW100-IOADR	I/O expansion and infrared remote control module ¹⁾	
CFW100-IOAR	I/O expansion module with 1 analog input and 1 relay output	
CFW100-IOD	I/O expansion module with 4 isolated (configurable) NPN or PNP digital inputs	
CFW100-CCAN	CANopen communication module	
CFW100-IOP	Potentiometer plug-in module	
Flash memory		
CFW100-MMF	Flash memory module (3 m cable included)	
External HMI		
CFW100-KHMIR	CFW100 remote interface kit (CFW100-CRS485 + 3 m cable included)	
RFI filter		
CFW100-KFABC-S1	Footprint radiofrequency filter kit ²⁾ , category C2, for frames A, B or C single-phase at 110V	
CFW100-KFABC-S2	Footprint radiofrequency filter kit ²⁾ , category C2, for frames A, B or C single-phase at 220V	
Others		
PLMP	Adapter kit for surface mounting, fastening with screws, set with two units	

Reference	Function								
	Inputs		Output		USB	Potentiometer	Infrared	Network communication	
	Analog	Digital ¹⁾	Analog	Relay digital				RS485	CANopen
CFW100-CRS485	-	-	-	-	-	-	-	1	-
CFW100-CCAN	-	-	-	-	-	-	-	-	1
CFW100-IOP	-	-	-	-	-	1	-	-	-
CFW100-CUSB	-	-	-	-	1	-	-	-	-
CFW100-IOA	1	-	1	-	-	-	-	-	-
CFW100-IOADR	1	-	-	3	-	-	1	-	-
CFW100-IOAR	1	-	-	1	-	-	-	-	-
CFW100-IOD ²⁾	-	4	-	-	-	-	-	-	-

MINI DRIVE CFW100 G2



Compact and innovative design. Flexible selection.

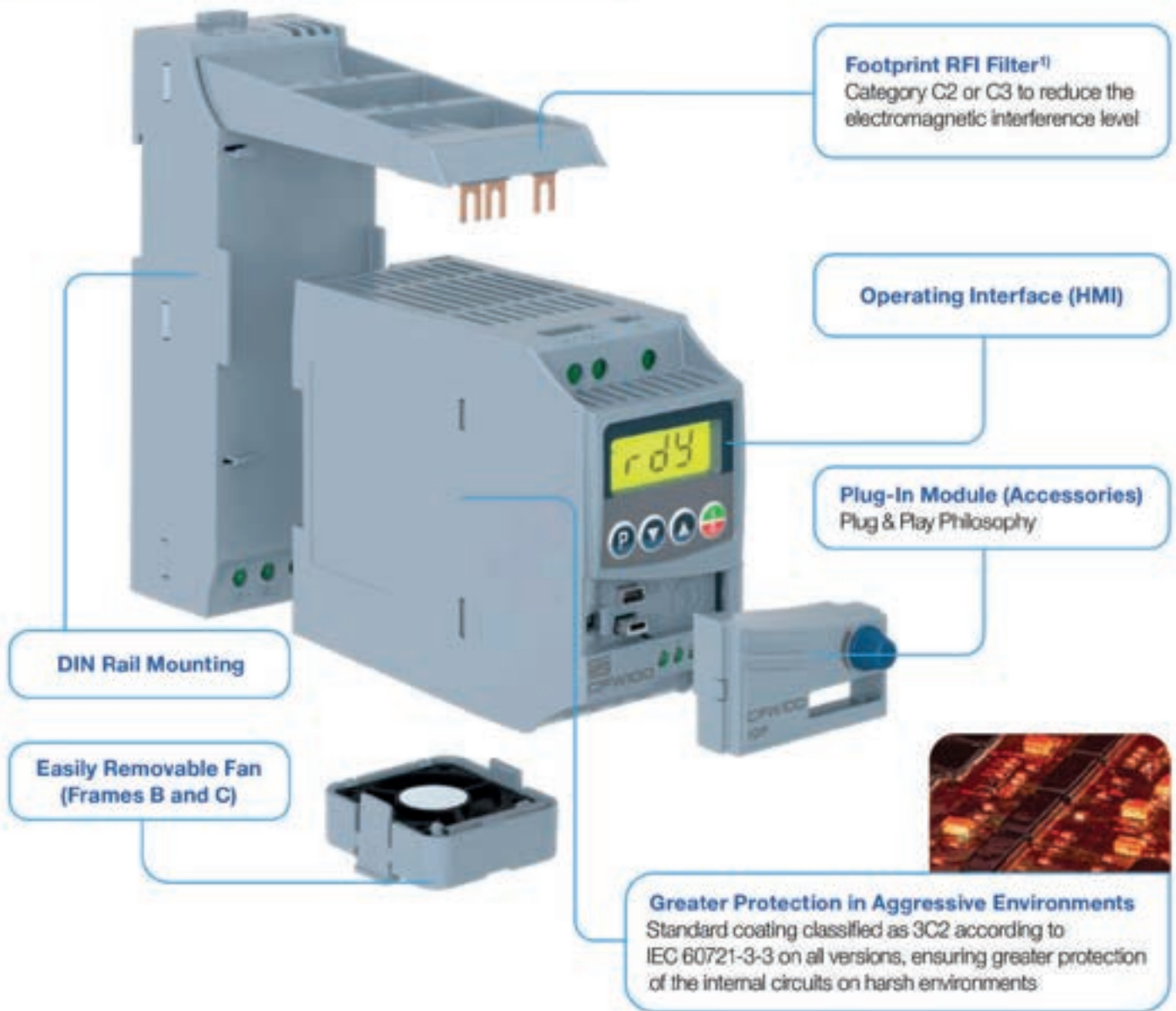

Flash Memory Module
Download/Upload of the programming from/to other CFW100 units without having to power them up

CFW100/CFW300-MMF Accessory



Remote HMI²⁾

CFW100-RHMR Accessory







CFW100 MINI DRIVE G2 - IP20

SINGLE-PHASE INPUT 230V, THREE-PHASE OUTPUT 240V						
Product code / Description	Current	Motor	Frame Size	Weight	Dimensions (1) H x W x D	Price NZ\$
230V - 1AC	(A)	(kW)		Kg	(mm)	
CFW100A01P6S220G2RFikit CFW100 0.37kW WEG MINI VSDRIVE 1.6AMP 240V G2 & RFI Kit	1.6	0.37	A	0.48	176 x 55 x 171	702.00
CFW100B02P6S220G2RFikit CFW100 0.75kW WEG MINI VSDRIVE 2.6AMP 240V G2 & RFI Kit	2.6	0.75	B	0.57	176 x 55 x 171	756.00
CFW100C04P2S220G2RFikit CFW100 1.1kW WEG MINI VSDRIVE 4.2AMP 240V G2 & RFI Kit	4.2	1.1	C	0.61	176 x 55 x 171	783.00



CFW100 MINI DRIVE ACCESSORIES

Part Number	Description	Price NZ\$
Expansion Modules 		
CFW100-IOAR	CFW100 Expansion Module (1 AI and 1 DO)	131.00
CFW100-IOA	CFW100 Expansion Module (1 AI and 1 AO)	166.00
CFW100-IOD	CFW100 Expansion Module (4 DI - PNP or NPN)	131.00
CFW100-IOP	CFW100 Expansion Module (Potentiometer) (1)	141.00
Communication Modules 		
CFW100-CRS485	CFW100 RS485 Communication Module	141.00
CFW100-CUSB	CFW100 USB Communication Module (with 2m cable)	229.00
CFW100-CCAN	CFW100 CANopen and DeviceNet Communication Module	242.00
CFW100-IOADR	CFW100 InfraRed Communication Module + IR remote control	449.00
Memory flash Module 		
CFW100-MMF	CFW100 Memory Flash Module (with 3m cable)	369.00
Remote Keypad 		
CFW100-KHMIR	CFW100 Kit for remote keypad (with CFW100-CRS485 + 3m cable)	498.00

(1) Only for G2 drives

CFW300

High performance VSD ideal for applications in small machines or other equipment. Suited for more complex applications.



Range 0.37kW to 7.5kW



230V Single Phase



415V Three Phase



IP20



SoftPLC Built-In



Scalar (V/F) or Vector VVW Control

EASY DRIVE CFW300



- **Sizes:** 230V single phase
0.37kW (1.6A) up to 2.2Kw (10A)
415V three phase
0.37kW (1.1A) up to 7.5kW (15A)
- V/F, quadratic V/F or VVW vector control
- Heavy Duty drive - withstands an overload of 150% for one minute every 10 minutes
- Engineering units (V, A, Hz, rpm, s, °C, %, etc.)
- Switching frequency selecting according to the application requirements
- Speed reference by frequency input signal
- Slip compensation or automatic torque boost (V/F scalar mode) or self-tuning (VVW vector mode)
- Internal dynamic braking (frame sizes B and C)
- PID controller to control processes in closed loop (via software WPS)
- Flying start / ride through



- Skip frequency or frequency ranges
- SoftPLC programming via free WLP software
- Fan control
- Energy saving function
- Fire mode
- Modbus master function

PLUG-IN MODULES AND ACCESSORIES

Reference	Description	Illustrative images
Upper slot - network communication and accessibility		
CFW300-CRS485	RS485 communication module	
CFW300-CUSB	USB communication module (2 m cable included)	
CFW300-CRS232	RS232 communication module	
CFW300-CCAN	CANopen or DeviceNet communication module	
CFW300-CPDP	Profibus-DP communication module	
CFW300-IOP	Potentiometer reference module	
CFW300-CETH	Ethernet communication module	
Lower slot - input and output (I/O) expansion		
CFW300-IOAR	1 analog input, 1 analog output and 3 relay outputs	
CFW300-IODR	4 digital inputs and 3 relay outputs	
CFW300-IOAENC	1 analog input, 2 analog outputs and input for incremental encoder	
CFW300-IOADR	1 NTC input, 3 relay outputs and 1 input for infrared sensor (infrared sensor, NTC and remote control with battery included)	
CFW300-IODF	3 frequency digital inputs, 3 frequency digital outputs, for multipump application	
Remote operating interface (HMI)		
CFW300-KHMIR	Kit with remote HMI (CFW300-CRS485 + 3 m cable included)	
Flash memory		
CFW300-MMF	Flash memory module (1 m cable included)	

EASY DRIVE CFW300



Flash Memory Module (CFW300-MMF Accessory)
Downloads the original parameter setting to several other CFW300 variable speed drives, even when they are turned off



2 Slots for Function Expansion with Accessories

Slot for network communication and potentiometer module

Slot for input and output (I/O) expansion modules



Easily Removable Fan



RFI Filter (CFW300-KFA / B / C Accessory)
Category C2 or C3 to reduce the electromagnetic interference level

Remote Operating Interface (HMI) (CFW300-KHMIR Accessory)



Greater Protection for Aggressive Environments
Standard Class 3C2 coating on the internal circuits of all versions, according to IEC 60721-3-3, ensures greater protection for environments with corrosive chemicals

Reference	Slots ⁵⁾	Inputs			Outputs			Potentiometer	USB ⁴⁾	Infrared sensors and NTC ³⁾	Encoder ²⁾	Network communication		
		Analog	Digital	Frequency	Analog	Digital / relay	Frequency					RS485	RS232	Other
CFW300-CRS485	Upper slot	-	-	-	-	-	-	-	-	-	-	1	-	-
CFW300-CRS232		-	-	-	-	-	-	-	-	-	-	-	1	-
CFW300-CCAN		-	-	-	-	-	-	-	-	-	-	-	-	CANopen or DeviceNet
CFW300-CPDP		-	-	-	-	-	-	-	-	-	-	-	-	Profibus-DP
CFW300-CUSB		-	-	-	-	-	-	-	1	-	-	-	-	-
CFW300-IOP		-	-	-	-	-	-	-	1	-	-	-	-	-
CFW300-CETH		-	-	-	-	-	-	-	-	-	-	-	-	Modbus-TCP
CFW300-IOAR	Lower slot	1	-	-	1	3	-	-	-	-	-	-	-	-
CFW300-IODR ¹⁾		-	4	-	-	3	-	-	-	-	-	-	-	-
CFW300-IOAENC		1	-	-	-	2	-	-	-	-	-	1	-	-
CFW300-IOADR		1	-	-	-	-	3	-	-	-	1	-	-	-
CFW300-IOADR-D		-	-	-	-	-	3	-	-	-	1	-	-	-
CFW300-IODF		-	-	3	-	-	-	3	-	-	-	-	-	-







CFW300 EASY DRIVE - IP20

SINGLE-PHASE INPUT 230V, THREE-PHASE OUTPUT 240V							
Product code / Description	Current (A)	Motor (kW)	Frame Size	Brake Chopper	Weight (Kg)	Dimensions H x W x D (mm)	Price NZ\$
230V - 1AC							
CFW300A01P6S2NB20RFIkit 0.37kW WEG CFW300 VSDRIVE 1.6AMP 240V incl RFI	1.6	0.37	A	N	0.9	157.9 x 70 x 148.4	830.00
CFW300A02P6S2NB20RFIkit 0.75kW WEG CFW300 VSDRIVE 2.6AMP 240V incl RFI	2.6	0.75	A	N	0.9	157.9 x 70 x 148.4	881.00
CFW300A04P2S2NB20RFIkit 1.1kW WEG CFW300 VSDRIVE 4.2AMP 240V incl RFI	4.2	1.1	A	N	0.9	157.9 x 70 x 148.4	928.00
CFW300A07P3S2NB20RFIkit 2.2kW WEG CFW300 VSDRIVE 7.3AMP 240V incl RFI	7.3	2.2	A	N	0.9	157.9 x 70 x 148.4	1,298.00
CFW300B10P0B2DB20RFIkit 3kW WEG CFW300 VSDRIVE 10AMP 240V incl RFI	10	3	B	Y	1.34	198.9 x 70 x 158.4	1,544.00
380,,480 V - 3AC - With Brake Chopper							
CFW300B01P1T4DB20RFIkit 0.37kW WEG CFW300 VSDRIVE 1.1AMP 415V incl RFI	1.1	0.37	B	Y	1.34	198.9 x 70 x 158.4	1,582.00
CFW300B01P8T4DB20RFIkit 0.75kW WEG CFW300 VSDRIVE 1.8AMP 415V incl RFI	1.8	0.75	B	Y	1.34	198.9 x 70 x 158.4	1,651.00
CFW300B02P6T4DB20RFIkit 1.1kW WEG CFW300 VSDRIVE 2.6AMP 415V incl RFI	2.6	1.1	B	Y	1.34	198.9 x 70 x 158.4	1,814.00
CFW300B03P5T4DB20RFIkit 1.5kW WEG CFW300 VSDRIVE 3.5AMP 415V incl RFI	3.5	1.5	B	Y	1.34	198.9 x 70 x 158.4	1,944.00
CFW300B04P8T4DB20RFIkit 2.2kW WEG CFW300 VSDRIVE 4.8AMP 415V incl RFI	4.8	2.2	B	Y	1.34	198.9 x 70 x 158.4	2,163.00
CFW300B06P5T4DB20RFIkit 3kW WEG CFW300 VSDRIVE 6.5AMP 415V incl RFI	6.5	3	B	Y	1.34	198.9 x 70 x 158.4	2,786.00
CFW300B08P2T4DB20RFIkit 4kW WEG CFW300 VSDRIVE 8.2AMP 415V incl RFI	8.2	4	B	Y	1.34	198.9 x 70 x 158.4	2,849.00
CFW300C10P0T4DB20RFIkit 4kW WEG CFW300 VSDRIVE 10AMP 415V incl RFI	10	4	C	Y	1.5	214 x 89 x 164	3,045.00
CFW300C12P0T4DB20RFIkit 5.5kW WEG CFW300 VSDRIVE 12AMP 415V incl RFI	12	5.5	C	Y	1.5	214 x 89 x 164	3,229.00
CFW300C15P0T4DB20RFIkit 7.5kW WEG CFW300 VSDRIVE 15AMP 415V incl RFI	15	7.5	C	Y	1.5	214 x 89 x 164	3,980.00



CFW300 EASY DRIVE ACCESSORIES

Part Number	Item Name	Price NZ\$
		
Communication Modules		
CFW300-CRS232	CFW300 RS-232 serial communication module (Modbus-RTU)	141.00
CFW300-CRS485	CFW300 RS-485 serial communication module (Modbus-RTU)	141.00
CFW300-CCAN	CFW300 CAN interface module (CANopen/DeviceNet)	193.00
CFW300-CPDP	CFW300 Profibus DP & DP-V1 interface module	526.00
CFW300-CUSB	CFW300 USB communication module + 2m cable	178.00
CFW300-CETH	CFW300 Ethernet communication module	733.00
		
Expansion Modules		
CFW300-IODR	CFW300 IODR expansion module - Insulated inputs (NPN or PNP)	238.00
CFW300-IOAR	CFW300 IOAR expansion module (1AI, 1AO and 3RO)	262.00
CFW300-IOADR	CFW300 IOADR expansion module (1 PTC, 3RO and 1 infrared input) Remote control with battery, infrared sensor and NTC sensor included	371.00
CFW300-IOAENC	CFW300 Encoder module - Incremental Encoder (A/A - B/B) +5Vdc@100 mA power supply, max frequency 400 kHz	309.00
		
Flash Memory		
CFW300-MMF	CFW300 Flash memory module (1m cable)	351.00
		
Remote Keypad		
CFW300-KHMIR	CFW300 Kit for remote keypad (with CFW300-CRS485 + 3m cable)	498.00

CFW500

This VSD is extremely compact and cost-effective. The robust flexible design fulfils the need of a wide range of applications.



Range 0.37kW to 110kW



230V Single Phase



415V Three Phase



SoftPLC Built-In



High Overload Capacity - 150% for 60s, every 10min



Solar Plug-In Module

MACHINERY DRIVE CFW500



- **Sizes:** 230V single phase
0.37kW (1.6A) up to 2.2Kw (10A)
415V three phase
0.55kW (1.6A) to 110kW (211A)
- Special engineering units (RPM, °C, Nm, mA, %, kW, kWh, among others)
- Heavy Duty drive - withstands an overload of 150% for one minute every 10 minutes
- Setting of the switching frequency according to the application requirements
- Internal dynamic braking (except frame size A)
- Pump Genius Multipump able
- Safety functions: STO and SS1
- IP66 version available



PLUG-IN MODULES AND ACCESSORIES

Reference	Description	Illustrative figures
	Input and output (I/O) expansion	
CFW500-IOS ¹⁾	Standard plug-in module (included in the version with plug-in module)	
CFW500-IOD	Digital input and output (I/O) expansion plug-in module	
CFW500-IOAD	Digital and analog input and output (I/O) expansion plug-in module	
CFW500-IOR-B	Relay output expansion plug-in module	
Functionality expansion		
CFW500-ENC	Plug-in module with encoder input	
CFW500-CUSB	Plug-in module with USB port	
Communication on Fieldbus network		
CFW500-CCAN	CAN communication plug-in module (CANopen/DeviceNet)	
CFW500-CRS232	RS232 communication plug-in module	
CFW500-CRS485-B	RS485 communication plug-in module	
CFW500-CPDP	Profibus-DP communication plug-in module	
CFW500-CETH-IP	EtherNet/IP communication plug-in module	
CFW500-CEMB-TCP	Modbus-TCP communication plug-in module	
CFW500-CEPN-IO	PROFINET IO communication plug-in module	
Reference	Description	Illustrative figures
	Memory	
CFW500-MMF	Flash memory module	
Interfaces		
CFW500-HMIR	Remote operating interface (HMI)	
CFW500-CCHMIR1M	1-meter cable set for remote operating interface (HMI)	
CFW500-CCHMIR2M	2-meter cable set for remote operating interface (HMI)	
CFW500-CCHMIR3M	3-meter cable set for remote operating interface (HMI)	
CFW500-CCHMIR5M	5-meter cable set for remote operating interface (HMI)	
CFW500-CCHMIR75M	7.5-meter cable set for remote operating interface (HMI)	
CFW500-CCHMIR10M	10-meter cable set for remote operating interface (HMI)	
Description		
CFW500-KN1A	NEMA 1 Kit - size A (standard for option N1)	
CFW500-KN1B	NEMA 1 Kit - size B (standard for option N1)	
CFW500-KN1C	NEMA 1 Kit - size C (standard for option N1)	
CFW500-KN1D	NEMA 1 Kit - size D (standard for option N1)	
CFW500-KN1E	NEMA 1 Kit - size E (standard for option N1)	
CFW500-KPCSA	Shielding kit for the power cables - size A (standard for option C2 and C3)	
CFW500-KPCSB	Shielding kit for the power cables - size B (standard for option C2 and C3)	
CFW500-KPCSC	Shielding kit for the power cables - size C (standard for option C2 and C3)	
CFW500-KPCSD	Shielding kit for the power cables - size D (standard for option C2 and C3)	
CFW500-KPCSE	Shielding kit for the power cables - size E (standard for option C2 and C3)	



ACCESSORIES

Configuration of the Plug-In Modules¹

Plug-in module	Functions																
	Inputs		Outputs			USB port	Input for Encoder ³⁾	Fieldbus networks							Supply		
	Digital	Analog	Analog	Digital relay	Digital transistor			CANopen DeviceNet	RS232	RS485	Profibus-DP	EtherNet/IP	Modbus-TCP	PROFINET IO	10 V	24 V	
CFW500-IOS	4	1	1	1	1	-	-	-	-	1	-	-	-	-	-	1	1
CFW500-IOD	8	1	1	1	4	-	-	-	-	1	-	-	-	-	-	1	1
CFW500-IOAD	6	3	2	1	3	-	-	-	-	1	-	-	-	-	-	1	1
CFW500-IOR-B	5 ²⁾	1	1	4	1	-	-	-	-	1	-	-	-	-	-	1	1
CFW500-ENC	5 ²⁾	1	1	4	1	-	1	-	-	1	-	-	-	-	-	1	1
CFW500-CUSB	4	1	1	1	1	1	-	-	-	1	-	-	-	-	-	1	1
CFW500-CCAN	2	1	1	1	1	-	-	1	-	1	-	-	-	-	-	1	-
CFW500-CRS232	2	1	1	1	1	-	-	-	1	1	-	-	-	-	-	-	1
CFW500-CRS485-B	4	2	1	2	1	-	-	-	-	2	-	-	-	-	-	1	1
CFW500-CPDP	2	1	1	1	1	-	-	-	-	1	1	-	-	-	-	-	1
CFW500-CETH-IP	2	1	1	1	1	-	-	-	-	1	-	1	-	-	-	-	1
CFW500-CEMB-TCP	2	1	1	1	1	-	-	-	-	1	-	-	1	-	-	-	1
CFW500-CEPN-IO	2	1	1	1	1	-	-	-	-	1	-	-	-	1	-	-	1



CFW500 G2 MACHINERY DRIVE - IP20

Part Number / Item Name	Duty	Amps	Motor (1) kW	Frame	Braking Chopper	Dimensions H x W x D mm	Weight Kg	Price NZ\$
230 V - 1 AC								
CFW500A01P6S2NB20C2G2 CFW500 G2 0,37kW WEG VSDrive 1,6AMP 230V IOS & Filter	HD	1,6	0,37	A	N	189 x 76 x 150	0,8	\$1,171.00
CFW500A02P6S2NB20C2G2 CFW500 G2 0,75kW WEG VSDrive 2,6AMP 230V IOS & Filter	HD	2,6	0,75	A	N	189 x 76 x 150	0,8	\$1,183.00
CFW500A04P3S2NB20C2G2 CFW500 G2 1,1kW WEG VSDrive 4,3AMP 230V IOS & Filter	HD	4,3	1,1	A	N	189 x 76 x 150	0,8	\$1,293.00
CFW500A07P0S2NB20C3G2 CFW500 G2 1,5kW WEG VSDrive 7AMP 230V IOS & Filter	HD	7	1,5	A	N	189 x 76 x 150	0,8	\$1,802.00
CFW500B10P0S2DB20C2G2 CFW500 G2 3kW WEG VSDrive 10AMP 230V IOS & Filter	HD	10	3	B	Y	199 x 100 x 160	1,2	\$2,221.00
380,,,480 V - 3AC - No Brake Chopper								
CFW500A01P6T4NB20C2G2 CFW500 G2 0,75kW WEG VSDrive 1,6AMP 415V IOS & Filter	HD	1,6	0,55	A	N	190 x 76 x 150	0,8	\$1,534.00
CFW500A02P6T4NB20C2G2 CFW500 G2 1,1kW WEG VSDrive 2,6AMP 415V IOS & Filter	HD	2,6	1,1	A	N	190 x 76 x 150	0,8	\$1,680.00
CFW500A04P3T4NB20C2G2 CFW500 G2 1,5kW WEG VSDrive 4,3AMP 415V IOS & Filter	HD	4,3	1,5	A	N	190 x 76 x 150	0,8	\$1,868.00
CFW500A06P1T4NB20C3G2 CFW500 G2 3kW WEG VSDrive 6,1AMP 415V IOS & Filter	HD	6,1	3	A	N	190 x 76 x 150	0,8	\$2,274.00
380,,,480 V - 3AC - With Brake Chopper								
CFW500B06P5T4DB20C2G2 CFW500 G2 2,2kW WEG VSDrive 6,5AMP 415V IOS & Filter	HD	6,5	3	B	Y	199 x 100 x 160	1,2	\$2,383.00
CFW500B10P0T4DB20C3G2 CFW500 G2 4kW WEG VSDrive 10AMP 415V IOS & Filter	HD	10	4	B	Y	199 x 100 x 160	1,2	\$2,722.00
CFW500C14P0T4DB20C2G2 CFW500 G2 5,5kW WEG VSDrive 14AMP 415V IOS & Filter	HD	14	5,5	C	Y	210 x 135 x 165	2,0	\$3,289.00
CFW500C16P0T4DB20C2G2 CFW500 G2 7,5kW WEG VSDrive 16AMP 415V IOS & Filter	HD	16	7,5	C	Y	210 x 135 x 165	2,0	\$3,682.00
CFW500D24P0T4DB20C3G2 CFW500 G2 11kW WEG VSDrive 24AMP 415V IOS & Filter	HD	24	11	D	Y	306.6 x 180 x 166.5	4,3	\$3,981.00
CFW500D31P0T4DB20C3G2 CFW500 G2 15kW WEG VSDrive 31AMP 415V IOS & Filter	HD	31	15	D	Y	306.6 x 180 x 166.5	4,3	\$4,658.00
CFW500E39P0T4DB20C3G2 CFW500 G2 18.5kW WEG VSDrive 39AMP 415V IOS & Filter	HD	39	18.5	E	Y	350 x 220 x 191.5	10	\$6,173.00
CFW500E49P0T4DB20C3G2 CFW500 G2 22kW WEG VSDrive 49AMP 415V IOS & Filter	HD	49	22	E	Y	350 x 220 x 191.5	10	\$6,841.00
CFW500F77P0T4DB20C3G2 CFW500 G2 37kW WEG VSDrive 77AMP 415V IOS & Filter	ND	77	37	F	Y	550 x 300 x 254	26	\$9,277.00
CFW500F88P0T4DB20C3G2 CFW500 G2 45kW WEG VSDrive 88AMP 415V IOS & Filter	ND	88	45	F	Y	550 x 300 x 254	26	\$12,534.00
CFW500F105T4DB20C3G2 CFW500 G2 55kW WEG VSDrive 105AMP 415V IOS & Filter	ND	105	55	F	Y	550 x 300 x 254	26	\$16,607.00
CFW500G0142T4DB20C3G2 CFW500 G2 75kW WEG VSDrive 142AMP 415V IOS & Filter	ND	142	75	G	Y	675 x 335.3 x 314	52	\$19,236.00
CFW500G0180T4DB20C3G2 CFW500 G2 90kW WEG VSDrive 180AMP 415V IOS & Filter	ND	180	90	G	Y	675 x 335.3 x 314	52	\$21,115.00
CFW500G0211T4DB20C3G2 CFW500 G2 110kW WEG VSDrive 211AMP 415V IOS & Filter	ND	211	110	G	Y	675 x 335.3 x 314	52	\$26,174.00











CFW500 G2 MACHINERY DRIVE - IP66

Part Number / Item Name	Duty	Motor (1)		Frame	Braking Chopper	Dimensions H x W x D mm	Weight Kg	Price NZ\$
		Amps	kW					
230 V - 1 AC								
CFW500A01P6S2DB66C3DSG2	HD	1,6	0,37	A	Y	265 x 165 x 252,5	10	\$1,697.00
CFW500 G2 0,37kW WEG VSDrive 1,6AMP 230V 1PH IP66 + Switch + IOS & Filte								
CFW500A02P6S2DB66C3DSG2	HD	2,6	0,75	A	Y	265 x 165 x 252,5	10	\$1,712.00
CFW500 G2 0,75kW WEG VSDrive 2,6AMP 230V 1PH IP66 + Switch + IOS & Filte								
CFW500A04P3S2DB66C3DSG2	HD	4,3	1,1	A	Y	265 x 165 x 252,5	10	\$1,873.00
CFW500 G2 1,1kW WEG VSDrive 4,3AMP 230V 1PH IP66 + Switch + IOS & Filter								
CFW500A07P3S2DB66C3DSG2	HD	7,3	2,2	A	Y	265 x 165 x 252,5	10	\$2,949.00
CFW500 G2 1,5kW WEG VSDrive 7,3AMP 230V 1PH IP66 + Switch + IOS & Filter								
CFW500A10P0S2DB66C3DSG2	HD	10	3	A	Y	265 x 165 x 252,5	10	\$3,221.00
CFW500 G2 3kW WEG VSDrive 10AMP 230V 1PH IP66 + Switch + IOS & Filter								
380,,480 V - 3AC - With Brake Chopper								
CFW500A01P6T4DB66C3DSG2	HD	1,6	0,55	A	Y	265 x 165 x 252,5	10	\$2,245.00
CFW500 G2 0,75kW WEG VSDrive 1,6AMP 415V 3PH IP66 + Switch + IOS & Filte								
CFW500A02P6T4DB66C3DSG2	HD	2,6	1,1	A	Y	265 x 165 x 252,5	10	\$2,576.00
CFW500 G2 1,1kW WEG VSDrive 2,6AMP 415V 3PH IP66 + Switch + IOS & Filter								
CFW500A04P3T4DB66C3DSG2	HD	4,3	1,5	A	Y	265 x 165 x 252,5	10	\$3,134.00
CFW500 G2 1,5kW WEG VSDrive 4,3AMP 415V 3PH IP66 + Switch + IOS & Filter								
CFW500A06P5T4DB66C3DSG2	HD	6,5	3	A	Y	265 x 165 x 252,5	10	\$3,462.00
CFW500 G2 2,2kW WEG VSDrive 6,5AMP 415V 3PH IP66 + Switch + IOS & Filter								
CFW500A10P0T4DB66C3DSG2	HD	10	4	A	Y	265 x 165 x 252,5	10	\$3,953.00
CFW500 G2 4kW WEG VSDrive 10AMP 415V 3PH IP66 + Switch + IOS & Filter								
CFW500B14P0T4DB66C3DSG2	HD	14	5,5	B	Y	340 x 215 x 252,9	12	\$4,699.00
CFW500 G2 5,5kW WEG VSDrive 14AMP 415V 3PH IP66 + Switch + IOS & Filter								
CFW500B16P0T4DB66C3DSG2	HD	16	7,5	B	Y	340 x 215 x 252,9	12	\$5,264.00
CFW500 G2 7,5kW WEG VSDrive 16AMP 415V 3PH IP66 + Switch + IOS & Filter								
CFW500B24P0T4DB66C3DSG2	HD	24	11	B	Y	340 x 215 x 252,9	12	\$5,693.00
CFW500 G2 11kW WEG VSDrive 24AMP 415V 3PH IP66 + Switch + IOS & Filter								
CFW500B31P0T4DB66C3DSG2	HD	31	15	B	Y	340 x 215 x 252,9	12	\$6,657.00
CFW500 G2 15kW WEG VSDrive 31AMP 415V 3PH IP66 + Switch + IOS & Filter								

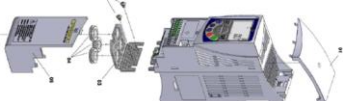

CFW500 MACHINERY DRIVE ACCESSORIES

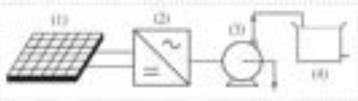
Part Number	Item Name	Price NZ\$
	 	
CFW500-IOS	CFW500 IOS standard I/O expansion module	189.00
CFW500-IOD	CFW500 IOD expansion module	242.00
CFW500-IOAD	CFW500 IOAD expansion module	312.00
CFW500-IOR	CFW500 IOR expansion module	214.00
CFW500G2-SFY2	CFW500 G2 Plug-in module with STO and SS1 safety functions	223.00
CFW500-CUSB	CFW500 USB communication module + Cable	360.00
CFW500-CCAN	CFW500 CAN interface module (CANopen/DeviceNet)	198.00
CFW500-CRS232	CFW500 RS-232 serial communication module (Modbus-RTU)	198.00
CFW500-CRS485-B	CFW500 RS-485 serial communication module (Modbus-RTU)	201.00
CFW500-CPDP	CFW500 Profibus DP & DP-V1 interface module (DB9 connector)	670.00
CFW500-CPDP2	CFW500 Profibus DP & DP-V1 interface module (terminal block connector)	670.00
CFW500-CEMB-TCP	CFW500 Modbus TCP communication module	826.00
CFW500-CEPN-IO	CFW500 Profinet/IO communication module	826.00
CFW500-CETH-IP	CFW500 Ethernet/IP communication module	826.00
CFW500-ENC	CFW500 Encoder module	359.00
	 	
Memory		
CFW500-MMF	CFW500 Flash memory module	300.00
	 	
Remote		
CFW500-HMIR	CFW500 Remote keypad	377.00
CFW500G2-HMI-01	CFW500 G2 Alphanumeric HMI	377.00
CFW500G2-RHMIF	CFW500 G2 HMI Frame	48.00
CFW500-CCHMIR01M	CFW500 1m (3.3ft) remote keypad cable	51.00
CFW500-CCHMIR02M	CFW500 2m (6.6ft) remote keypad cable	64.00
CFW500-CCHMIR03M	CFW500 3m (10ft) remote keypad cable	81.00
CFW500-CCHMIR05M	CFW500 5m (16ft) remote keypad cable	107.00
CFW500-CCHMIR075M	CFW500 7.5m (25ft) remote keypad cable	124.00
CFW500-CCHMIR010M	CFW500 10m (33ft) remote keypad cable	145.00
		
Conduit Kit		
CFW500-KN1A	CFW500 NEMA 1 kit for frame A (1,6 - 6,2)Amp)	54.00
CFW500-KN1B	CFW500 NEMA 1 kit for frame B (6,5 - 10)Amp)	60.00
CFW500-KN1C	CFW500 NEMA 1 kit for frame C (14 - 16)Amp)	62.00
CFW500-KN1D	CFW500 NEMA 1 kit for frame D (24 - 31)Amp)	81.00
CFW500-KN1E	CFW500 NEMA 1 kit for frame E (39 - 49)Amp)	98.00
CFW500-KN1F	CFW500 NEMA 1 kit for frame F (77 - 105)Amp)	192.00
CFW500-KN1G	CFW500 NEMA 1 kit for frame G (142 - 211)Amp)	293.00
	 	
Solar Module		
CFW500-KPSA	CFW500 Frame Size A Solar Plug-in Module	311.00
CFW500-KPSB	CFW500 Frame Size B Solar Plug-in Module	321.00
CFW500-KPSC	CFW500 Frame Size C Solar Plug-in Module	328.00
CFW500-KPSD	CFW500 Frame Size D Solar Plug-in Module	337.00
CFW500-KPSE	CFW500 Frame Size E Solar Plug-in Module	343.00
CFW500-KDS	Voltage divider kit for connection of the solar radiation detector panel	500.00
CFW500-KPSA-KDS	CFW500 Frame Size A Solar Plug-in Module with Voltage divider kit	811.00
CFW500-KPSB-KDS	CFW500 Frame Size B Solar Plug-in Module with Voltage divider kit	821.00
CFW500-KPSC-KDS	CFW500 Frame Size C Solar Plug-in Module with Voltage divider kit	828.00
CFW500-KPSD-KDS	CFW500 Frame Size D Solar Plug-in Module with Voltage divider kit	837.00
CFW500-KPSE-KDS	CFW500 Frame Size E Solar Plug-in Module with Voltage divider kit	843.00

Prices Exclude GST and are subject to change at any time Ref: V24

CFW900

Complete solution with high performance and safety combined with maximum flexibility and connectivity



Range from 1.1kW



415V Three Phase (also 240V Single Phase)



IP20



SoftPLC Built-In



Scalar, VVW, Vector control: sensorless and with encoder and PM Motor VVW PM Control



Standard vast range of communication options



- **Sizes:** 230V single phase
1.1kW (4.6A) up to 3kW (10A)
415V three phase
From 1.1kW (2.8A)
- Advanced Energy Saving Function
- Intelligent Thermal Management
- Built-in RFI Suppressor Filter
- STO (Safe Torque Off) and SS1 (Safe Stop) - SIL 3/PL e safety level
- Inductor on DC Link Reduces Harmonic Distortion
- USB port
- Bluetooth
- Standard Dual RJ45 for Ethernet, EtherNet/IP, Modbus-TCP and MQTT communication
- Standard RS485 for Modbus-RTU communication
- Up to 16 Analog In/Outputs, 56 Digital In/Outputs
- Normal Duty (ND)
110% for 60 seconds every 5 minutes
150% for 3 seconds every 5 minutes
- Heavy Duty (HD)
150% for 60 seconds every 5 minutes
200% for 3 seconds every 5 minutes

ACCESSORIES

Name	Description
Communication accessories and functionality expansion	
CFW900-CCAN-W	CAN interface module (CANOpen/DeviceNet)
CFW900-ENC-01	Module for connecting an incremental encoder with a signal of up to 310kHz
CFW900-IOAI-01	Module with 3 analog inputs and 2 isolated analog outputs
CFW900-IOD-01	Module with 8 isolated digital inputs and 8 isolated digital outputs
CFW900-REL-01	Module with 3 digital relay outputs
CFW900-TEMP-01	Module with 6 isolated inputs for PTC/Pt-100/PT1000 sensors
Individual HMI, frame and cables for external HMI	
CFW900-HMI-BLT	HMI with Bluetooth interface (Individual item) (standard for option B)
CFW900-HMI	HMI (Individual)
CFW900-RHMIF	Frame kit for HMI (IP66 protection rating)
CFW900-CCHMIR01M	1 m serial cable for remote HMI
CFW900-CCHMIR02M	2 m serial cable for remote HMI
CFW900-CCHMIR03M	3 m serial cable for remote HMI
CFW900-CCHMIR05M	5 m serial cable for remote HMI
CFW900-CCHMIR07M	7.5 m serial cable for remote HMI
CFW900-CCHMIR10M	10 m serial cable for remote HMI
Others	
CFW900-4SLOTS	Backplane with 4 slots (A through D) to connect accessories (supplied as standard)
CFW900-7SLOTS	Backplane with 7 slots (A through G) to connect accessories
CFW900-KN1A	NEMA1 kit for frame A (standard for option N1)
CFW900-KN1B	NEMA1 kit for frame B (standard for option N1)
CFW900-KN1C	NEMA1 kit for frame C (standard for option N1)
CFW900-KN1D	NEMA1 kit for frame D (standard for option N1)
CFW900-KN1E	NEMA1 kit for frame E (standard for option N1)
CFW900-IP21A	IP21 hit for frame A
CFW900-IP21B	IP21 hit for frame B
CFW900-IP21C	IP21 hit for frame C
CFW900-IP21D	IP21 hit for frame E
CFW900-IP21E	IP21 hit for frame D
CFW900-SDC	8GB industrial temperature microSD card



CFW900 SYSTEM DRIVE - IP21 + STO + 2 ModBus TCP/IP ports + Bluetooth + 1 ModBus RTU + MQTT (IoT Ready)

6 DI + 2 DO + 2 AI + 2 AO + 3 RLO (1xCFW900-REL-01 accessory supplied as standard)

Product code / Description	Duty	Current A	Motor (2) kW	Frame Size	Weight (1) kg	Dimensions H x W x D	Price NZ\$
200...240 V - 1AC or 3AC							
CFW900A04P6B2DB20Y2B	ND HD	4.6 4.6	1.1 1.1	A	4.5	269.3 x 145 x 221.8	3,772.00
CFW900 1.1kW WEG VSDRIVE 4.6AMP 230V 1/3PH IP20 N Duty							
CFW900A06P0B2DB20Y2B	ND HD	6 6	1.5 1.5	A	4.5	269.3 x 145 x 221.8	3,903.00
CFW900 1.5kW WEG VSDRIVE 6AMP 230V 1/3PH IP20 N Duty							
CFW900A07P5B2DB20Y2B	ND HD	7.5 7.5	2.2 2.2	A	4.5	269.3 x 145 x 221.8	4,025.00
CFW900 2.2kW WEG VSDRIVE 7.5AMP 230V 1/3PH IP20 N Duty							
CFW900A10P0B2DB20Y2B	ND HD	10 10	3 3	A	4.5	269.3 x 145 x 221.8	4,240.00
CFW900 3kW WEG VSDRIVE 10AMP 230V 1/3PH IP20 N Duty							
380...480 V - 3AC							
CFW900A02P8T4DB20Y2B	ND HD	2.8 2.4	1.1 1.1	A	4.5	269.3 x 145 x 221.8	3,305.00
CFW900 1.1kW WEG VSDRIVE 2.8AMP 415V 3PH IP20 N Duty							
CFW900A03P6T4DB20Y2B	ND HD	3.6 2.8	1.5 1.1	A	4.5	269.3 x 145 x 221.8	3,559.00
CFW900 1.5kW WEG VSDRIVE 3.6AMP 415V 3PH IP20 N Duty							
CFW900A04P8T4DB20Y2B	ND HD	4.8 3.9	2.2 1.5	A	4.5	269.3 x 145 x 221.8	3,631.00
CFW900 2.2kW WEG VSDRIVE 4.8AMP 415V 3PH IP20 N Duty							
CFW900A06P5T4DB20Y2B	ND HD	6.5 5.3	3 2.2	A	4.5	269.3 x 145 x 221.8	3,670.00
CFW900 3kW WEG VSDRIVE 6.5AMP 415V 3PH IP20 N Duty							
CFW900A09P6T4DB20Y2B	ND HD	9.6 8	4 3	A	4.5	269.3 x 145 x 221.8	3,778.00
CFW900 4kW WEG VSDRIVE 9.6AMP 415V 3PH IP20 N Duty							
CFW900A14P0T4DB20Y2B	ND HD	14 12	5.5 5.5	A	4.5	269.3 x 145 x 221.8	4,513.00
CFW900 5.5kW WEG VSDRIVE 14AMP 415V 3PH IP20 N Duty							
CFW900A17P0T4DB20Y2B	ND HD	17 17	7.5 7.5	A	4.5	269.3 x 145 x 221.8	5,121.00
CFW900 7.5kW WEG VSDRIVE 17AMP 415V 3PH IP20 N Duty							
CFW900B26P0T4DB20Y2B	ND HD	26 21	11 11	B	10	385 x 165.3 x 226.8	5,787.00
CFW900 11kW WEG VSDRIVE 26AMP 415V 3PH IP20 N Duty							
CFW900B33P0T4DB20Y2B	ND HD	33 28	15 11	B	10	385 x 165.3 x 226.8	7,837.00
CFW900 15kW WEG VSDRIVE 33AMP 415V 3PH IP20 N Duty							
CFW900B39P0T4DB20Y2B	ND HD	39 33	18.5 15	B	10	385 x 165.3 x 226.8	8,941.00
CFW900 18.5kW WEG VSDRIVE 39AMP 415V 3PH IP20 N Duty							
CFW900C50P0T4DB20Y2B	ND HD	50 40	22 22	C	20.5	460 x 200 x 296.1	10,803.00
CFW900 22kW WEG VSDRIVE 50AMP 415V 3PH IP20 N Duty							
CFW900C62P0T4DB20Y2B	ND HD	62 50	30 22	C	20.5	460 x 200 x 296.1	13,001.00
CFW900 30kW WEG VSDRIVE 62AMP 415V 3PH IP20 N Duty							
CFW900C74P0T4DB20Y2B	ND HD	74 62	37 30	C	20.5	460 x 200 x 296.1	16,250.00
CFW900 37kW WEG VSDRIVE 74AMP 415V 3PH IP20 N Duty							
CFW900D96P0T4DB20Y2B	ND HD	96 75	45 37	D	33.5	625 x 250 x 294	20,241.00
CFW900 45kW WEG VSDRIVE 96AMP 415V 3PH IP20 N Duty							
CFW900D124T4DB20Y2B	ND HD	124 103	55 55	D	33.5	625 x 250 x 294	24,694.00
CFW900 55kW WEG VSDRIVE 124AMP 415V 3PH IP20 N Duty							
CFW900D146T4DB20Y2B	ND HD	146 124	75 55	D	33.5	625 x 250 x 294	27,107.00
CFW900 75kW WEG VSDRIVE 146AMP 415V 3PH IP20 N Duty							
CFW900E0172T4DB20Y2B	ND HD	172 146	90 75	E	63.5	675 x 335 x 358.1	POA
CFW900 90kW WEG VSDRIVE 172AMP 415V 3PH IP20 N Duty							
CFW900E0203T4DB20Y2B	ND HD	203 161	110 75	E	63.5	675 x 335 x 358.1	POA
CFW900 110kW WEG VSDRIVE 203AMP 415V 3PH IP20 N Duty							
CFW900E0242T4DB20Y2B	ND HD	242 190	132 90	E	63.5	675 x 335 x 358.1	POA
CFW900 132kW WEG VSDRIVE 242AMP 415V 3PH IP20 N Duty							



CFW900 SYSTEM DRIVE ACCESSORIES

Part Number	Description	Price NZ\$
I/O Expansion Modules		
CFW900-IOAI-01	CFW900 3 analog inputs and 2 isolated analog outputs	1,078.00
CFW900-IOD-01	CFW900 8 isolated digital inputs and 8 isolated digital outputs	792.00
CFW900-REL-01	CFW900 3 digital relay outputs (one module supplied with standard version)	353.00
Temperature Transducers Modules		
CFW900-TEMP-01	CFW900 6 isolated inputs for PTC, PT100 or PT1000 sensors	607.00
Encoder Modules		
CFW900-ENC-01	CFW900 Incremental encoder with a signal up to 310 kHz and repeater	682.00
Communication Modules		
CFW900-CCAN-W	CAN interface module (CANopen / DeviceNet)	424.00
CFW900-CPDP-N	CFW900 Profibus DP-V1 interface module	1,673.00
CFW900-CPN-IRT-N	CFW900 Profinet IRT interface module - 2 Ports	3,223.00
CFW900-CECAT-N	CFW900 EtherCAT interface module - 2 Ports	2,366.00
CFW900-CETH-IP-N	CFW900 Ethernet/IP interface module - 2 Ports	1,972.00
Backplane - Slot for Accessories		
CFW900-4SLOTS	CFW900 Backplane with 4 Slots (available in the standard version)	353.00
CFW900-7SLOTS	CFW900 Backplane with 7 Slots	443.00
Keypad Accessories		
CFW900-HMI-BLT	CFW900 CFW900 HMI with Bluetooth (available in the version B)	918.00
CFW900-HMI	CFW900 CFW900 HMI without Bluetooth	789.00
CFW900-RHMIF	CFW900 Frame for keypad remote assembly, IP66	114.00
Cables for HMI		
CFW900-CCHMIR01M	CFW900 1m (3.3ft) Remote Keypad Cable	122.00
CFW900-CCHMIR02M	CFW900 2m (6.6ft) Remote Keypad Cable	136.00
CFW900-CCHMIR03M	CFW900 3m (10ft) Remote Keypad Cable	146.00
CFW900-CCHMIR05M	CFW900 5m (16ft) Remote Keypad Cable	168.00
CFW900-CCHMIR07M	CFW900 7.5m (25ft) Remote Keypad Cable	200.00
CFW900-CCHMIR10M	CFW900 10m (33ft) Remote Keypad Cable	229.00
Conduit Kit		
CFW900-KN1A	CFW900 UL Type 1 - Conduit kit for frame size A	139.00
CFW900-KN1B	CFW900 UL Type 1 - Conduit kit for frame size B	161.00
CFW900-KN1C	CFW900 UL Type 1 - Conduit kit for frame size C	182.00
CFW900-KN1D	CFW900 UL Type 1 - Conduit kit for frame size D	324.00
CFW900-KN1E	CFW900 UL Type 1 - Conduit kit for frame size E	468.00
CFW900-IP21A	CFW900 IP21 - Kit for frame size A (top cover)	185.00
CFW900-IP21B	CFW900 IP21 - Kit for frame size B (top cover)	193.00
CFW900-IP21C	CFW900 IP21 - Kit for frame size C (top cover)	200.00
CFW900-IP21D	CFW900 IP21 - Kit for frame size D (top cover)	229.00
CFW900-IP21E	CFW900 IP21 - Kit for frame size E (top cover)	256.00

Prices Exclude GST and are subject to change at any time Ref: V24



AFW900 SYSTEM DRIVE PANEL - IP55 SELF SUPPORTED PANEL + STO + 2 EtherNet IP ports + Bluetooth

Product code / Description	Duty	Current A	Motor (2) kW	Frame Size	Weight (1) kg	Dimensions H x W x D	Price NZ\$
380...480 V - 3AC							
AFW900 A 02P8 T4 DB 55 Y2 B CB	ND	2.8	1.1				
AFW900 1.1kW WEG VSDRIVE SELF SUPORTED PANEL 2.8AMP 415V 3PH IP55 N Duty	HD	2.4	1.1	A	60	1000 x 400 x 300	POA
AFW900 A 03P6 T4 DB 55 Y2 B CB	ND	3.6	1.5				
AFW900 1.5kW WEG VSDRIVE SELF SUPORTED PANEL 3.6AMP 415V 3PH IP55 N Duty	HD	2.8	1.1	A	60	1000 x 400 x 300	POA
AFW900 A 04P8 T4 DB 55 Y2 B CB	ND	4.8	2.2				
AFW900 2.2kW WEG VSDRIVE SELF SUPORTED PANEL 4.8AMP 415V 3PH IP55 N Duty	HD	3.9	1.5	A	60	1000 x 400 x 300	POA
AFW900 A 06P5 T4 DB 55 Y2 B CB	ND	6.5	3				
AFW900 3kW WEG VSDRIVE SELF SUPORTED PANEL 6.5AMP 415V 3PH IP55 N Duty	HD	5.3	2.2	A	60	1000 x 400 x 300	POA
AFW900 A 09P6 T4 DB 55 Y2 B CB	ND	9.6	4				
AFW900 4kW WEG VSDRIVE SELF SUPORTED PANEL 9.6AMP 415V 3PH IP55 N Duty	HD	8	3	A	60	1000 x 400 x 300	POA
AFW900 A 14P0 T4 DB 55 Y2 B CB	ND	14	5.5				
AFW900 5.5kW WEG VSDRIVE SELF SUPORTED PANEL 14AMP 415V 3PH IP55 N Duty	HD	12	5.5	A	60	1000 x 400 x 300	POA
AFW900 A 17P0 T4 DB 55 Y2 B CB	ND	17	7.5				
AFW900 7.5kW WEG VSDRIVE SELF SUPORTED PANEL 17AMP 415V 3PH IP55 N Duty	HD	17	7.5	A	60	1000 x 400 x 300	POA
AFW900 B 26P0 T4 DB 55 Y2 B CB	ND	26	11				
AFW900 11kW WEG VSDRIVE SELF SUPORTED PANEL 26AMP 415V 3PH IP55 N Duty	HD	21	11	B	140	1620 x 400 x 600	POA
AFW900 B 33P0 T4 DB 55 Y2 B CB	ND	33	15				
AFW900 15kW WEG VSDRIVE SELF SUPORTED PANEL 33AMP 415V 3PH IP55 N Duty	HD	28	11	B	140	1620 x 400 x 600	POA
AFW900 B 39P0 T4 DB 55 Y2 B CB	ND	39	18.5				
AFW900 18.5kW WEG VSDRIVE SELF SUPORTED PANEL 39AMP 415V 3PH IP55 N Duty	HD	33	15	B	140	1620 x 400 x 600	POA
AFW900 C 50P0 T4 DB 55 Y2 B CB	ND	50	22				
AFW900 22kW WEG VSDRIVE SELF SUPORTED PANEL 50AMP 415V 3PH IP55 N Duty	HD	40	22	C	150	1620 x 400 x 600	POA
AFW900 C 62P0 T4 NB 55 Y2 B CB	ND	62	30				
AFW900 30kW WEG VSDRIVE SELF SUPORTED PANEL 62AMP 415V 3PH IP55 N Duty	HD	50	22	C	150	1620 x 400 x 600	POA
AFW900 C 74P0 T4 NB 55 Y2 B CB	ND	74	37				
AFW900 37kW WEG VSDRIVE SELF SUPORTED PANEL 74AMP 415V 3PH IP55 N Duty	HD	62	30	C	150	1620 x 400 x 600	POA
AFW900 D 96P0 T4 NB 55 Y2 B CB	ND	96	45				
AFW900 45kW WEG VSDRIVE SELF SUPORTED PANEL 96AMP 415V 3PH IP55 N Duty	HD	75	37	D	200	2020 x 400 x 600	POA
AFW900 D 0124 T4 NB 55 Y2 B CB	ND	124	55				
AFW900 55kW WEG VSDRIVE SELF SUPORTED PANEL 124AMP 415V 3PH IP55 N Duty	HD	103	55	D	200	2020 x 400 x 600	POA
AFW900 D 0146 T4 NB 55 Y2 B CB	ND	146	75				
AFW900 75kW WEG VSDRIVE SELF SUPORTED PANEL 146AMP 415V 3PH IP55 N Duty	HD	124	55	D	200	2020 x 400 x 600	POA
AFW900 E 0172 T4 NB 55 Y2 B CB	ND	172	90				
AFW900 90kW WEG VSDRIVE SELF SUPORTED PANEL 172AMP 415V 3PH IP55 N Duty	HD	146	75	E	250	2020 x 400 x 600	POA
AFW900 E 0203 T4 NB 55 Y2 B CB	ND	203	110				
AFW900 110kW WEG VSDRIVE SELF SUPORTED PANEL 203AMP 415V 3PH IP55 N Duty	HD	161	75	E	250	2020 x 400 x 600	POA
AFW900 E 0242 T4 NB 55 Y2 B CB	ND	242	132				
AFW900 132kW WEG VSDRIVE SELF SUPORTED PANEL 242AMP 415V 3PH IP55 N Duty	HD	190	90	E	250	2020 x 400 x 600	POA



AFW900 SELF SUPPORTED PANEL ACCESSORIES

Part Number	Description	Price NZ\$
I/O Expansion Modules		
CFW900-IOAI-01-A	AFW900 3 analog inputs and 2 isolated analog outputs - A	POA
CFW900-IOD-01-D	AFW900 8 isolated digital inputs and 8 isolated digital outputs - D	POA
CFW900-REL-01-L	AFW900 3 digital relay outputs (one module supplied with standard version) - L	POA
Temperature Transducers Modules		
CFW900-TEMP-01-T	AFW900 6 isolated inputs for PTC, PT100 or PT1000 sensors - T	POA
Encoder Modules		
CFW900-ENC-01-E	AFW900 Incremental encoder with a signal up to 310 kHz and repeater - E	POA
Communication Modules		
CFW900-CCAN-W-C	AFW900 CAN interface module (CANopen / DeviceNet) - C	POA
Backplane - Slot for Accessories		
CFW900-7SLOTS-7S	AFW900 Backplane with 7 Slots - 7S	POA
Keypad Accessories		
CFW900-HMI-BLT-B	AFW900 CFW900 HMI with Bluetooth (available in the version B) - B	POA
Local Remote Selector Switch		
SELECTOR-CSW-C-LR	AFW900 Local-Remote Selector Switch mounted on door - LR	POA

CFW11

Our flagship variable speed drive is a high-tech, easy-to-use VSD.



Range 1.5kW to 630kW



415V Three Phase



IP20 or IP55



Optimal Flux



SoftPLC Built-In



Scalar (V/f) or Vector V V W Control

SYSTEM DRIVE - CFW11



- **Sizes:** 230V single phase
1.5kW (6A) up to 3kW (10A)
415V three phase
1.5kW (3.6A) up to 630kW (1141A)

- Built-in RFI Filter
- Safe Torque Off (STO) Cat. 3/PL d acc. and SIL CL2 acc
- Normal & Heavy Duty ratings load faster
- Built-in bypass in the whole range
ND = Normal Duty overload every 10 mins:
110% for 60 secs or 150% for 3 secs
HD = Heavy Duty overload every 10 mins:
150% for 60 secs or 200% for 3 secs
- Built in DC link inductors



- USB port
- Built in PLC
- Also available in IP55 version and in a stand alone panel IP54

Expansion Module	Function									
	Inputs		Outputs			PTC	PT100	KTY84	Encoder	PLC
	Analog	Digital	Analog	Digital (RL)	Digital (TR)					
IOA-01	1	2	2		2					
IOB-01	2	2	2		2					
IOC-01		8		4						
IOC-01		8		4						
IOC-02		8			8					
IOC-03		8			7 ⁽¹⁾					
IOE-01						5				
IOE-02							5			
IOE-03								5		
ENC-01									1 ⁽²⁾	
ENC-02									1	
PLC11-01										1 ⁽¹⁾
PLC11-02										1 ⁽¹⁾

1. Need external power supply for digital outputs

2. Need external power supply for repeater circuit

PLC11-01

- 9 bi-directional inputs 24 V
- 3 bi-directional open collector outputs: 24 V dc, 500 mA
- 3 outputs for NO contacts: 250 V ac, 3 A
- 2 incremental encoder inputs 5...12 V dc, 500 mA (built-in power supply)
- 1 RS485 port (Modbus-RTU available)
- 1 CAN port (CANopen available)
- 1 differential input: -10...+ 10V dc / 0...20 mA, 14 bits
- 2 analog outputs: -10...+10 V dc / 0...20 mA, 12 bits

PLC11-02

- 4 isolated bi-directional inputs 24 V
- 3 bi-directional open collector outputs: 24 V dc, 500 mA
- 1 output for NO contacts: 250 V ac, 3 A
- 2 incremental encoder inputs 5...12 V dc, 500 mA (built-in power supply)
- 1 RS485 port (Modbus-RTU available)
- 1 CAN port (CANopen and DeviceNet available)



	Reference	Description	Slot	Image	
Communication	RS485-01	RS485 serial communication module (Modbus-RTU)	3		
	RS232-01	RS232 serial communication module (Modbus-RTU)	3		
	CAN/RS485-01	CAN/RS485 interface module (CANopen, DeviceNet, Modbus-RTU and BACnet)	3		
	CAN-01	CAN interface module (CANopen and DeviceNet)	3		
	PROFIBUS DP-01	Profibus-DP-V1 interface module	3		
	ETHERCAT-01	EtherCAT interface module	3		
	PROFDP-05	Profibus-DP-V1 module (Anybus-CC)	4		
	DEVICENET-05	DeviceNet module (Anybus-CC)	4		
	RS232-05	RS232 interface module (passive) (Modbus-RTU)	4		
	RS485-05	RS485 interface module (passive) (Modbus-RTU)	4		
	MODBUS-TCP-05	Interface module Modbus-TCP - 1 port		4	
		Interface module Modbus-TCP - 2 ports		4	
	PROFINET-ID-05	PROFINET ID interface module (Anybus-CC) - 1 port		4	
		PROFINET ID interface module (Anybus-CC) - 2 ports		4	
	ETHERNET-IP-05	EtherNet/IP interface module - 1 port		4	
		EtherNet/IP interface module - 2 ports		4	
PLC Functions	PLC11-01	Module with PLC functions (see page 26)	1, 2 and 3		
	PLC11-02	Module with PLC functions (see page 26)			



CFW11 SYSTEM DRIVE - IP21 + STO

Product code / Description	Duty	Current A	Motor (2) kW	Frame Size	Weight (1) kg	Dimensions H x W x D	Price NZ\$
200...240 V - 1AC							
CFW110006S2OFAZ 1.5kW WEG VSDRIVE 6AMP 230V 1PH IP21 N Duty	ND HD	6 5	1.5 1.1	A	6.3	247 x 145 x 227	3,717.00
CFW110007S2OFAZ 1.5kW WEG VSDRIVE 7AMP 230V 1PH IP21 N Duty	ND HD	7 7	1.5 1.5	A	6.3	247 x 145 x 227	3,833.00
CFW110010S2OFAZ 3kW WEG VSDRIVE 10AMP 230V 1PH IP21 N Duty	ND HD	10 10	3 3	A	6.3	247 x 145 x 227	4,038.00
380...480 V - 3AC							
CFW110003T4OFAYZ 1.5kW WEG VSDRIVE 3.6AMP 415V S Stop	ND HD	3.6 3.6	1.5 1.5	A	6.3	247 x 145 x 227	3,390.00
CFW110005T4OFAYZ 2.2kW WEG VSDRIVE 5AMP 415V S Stop	ND HD	5 5	2.2 2.2	A	6.3	247 x 145 x 227	3,458.00
CFW110007T4OFAYZ 3kW WEG VSDRIVE 7AMP 415V S Stop	ND HD	7 5.5	3 2.2	A	6.3	247 x 145 x 227	3,531.00
CFW110010T4OFAYZ 4kW WEG VSDRIVE 10AMP 415V S Stop	ND HD	10 10	4 4	A	6.3	247 x 145 x 227	3,598.00
CFW110013T4OFAYZ 5.5kW WEG VSDRIVE 13.5AMP 415V S Stop	ND HD	13.5 11	5.5 5.5	A	6.3	247 x 145 x 227	3,233.00
CFW110017T4OFAYZ 7.5kW WEG VSDRIVE 17AMP 415V S Stop	ND HD	17 13.5	7.5 5.5	B	10.4	293 x 190 x 227	4,877.00
CFW110024T4OFAYZ 11kW WEG VSDRIVE 24AMP 415V S Stop	ND HD	24 19	11 9.2	B	10.4	293 x 190 x 227	5,511.00
CFW110031T4OFAYZ 15kW WEG VSDRIVE 31AMP 415V S Stop	ND HD	31 25	15 11	B	10.4	293 x 190 x 227	6,410.00
CFW110038T4OFAYZ 18.5kW WEG VSDRIVE 38AMP 415V S Stop	ND HD	38 33	18.5 15	C	20.5	378 x 220 x 293	8,516.00
CFW110045T4OFAYZ 22kW WEG VSDRIVE 45AMP 415V S Stop	ND HD	45 38	22 18.5	C	20.5	378 x 220 x 293	9,431.00
CFW110058T4OFAYZ 30kW WEG VSDRIVE 58.5AMP 415V S Stop	ND HD	58.5 47	30 22	C	20.5	378 x 220 x 293	11,147.00
CFW110070T4OFAYZ 37kW WEG VSDRIVE 70.5AMP 415V S Stop	ND HD	70.5 61	37 30	D	32.6	504 x 300 x 305	13,616.00
CFW110088T4OFAYZ 45kW WEG VSDRIVE 88AMP 415V S Stop	ND HD	88 73	45 37	D	32.6	504 x 300 x 305	17,335.00
CFW110105T4OYZ 55kW WEG VSDRIVE 105AMP 415V S Stop	ND HD	105 88	55 45	E	65	620 x 334 x 358	21,219.00
CFW110142T4OYZ 75kW WEG VSDRIVE 142AMP 415V S Stop	ND HD	142 115	75 55	E	65	620 x 334 x 358	25,816.00
CFW110180T4OYZ 90kW WEG VSDRIVE 180AMP 415V S Stop	ND HD	180 142	90 75	E	65	620 x 334 x 358	POA
CFW110211T4OYZ 110kW WEG VSDRIVE 211AMP 415V S Stop	ND HD	211 180	110 90	E	65	620 x 334 x 358	POA
CFW110242T4OYZ 132kW WEG VSDRIVE 242AMP 415V S Stop	ND HD	242 211	132 110	F	168	1200 x 430 x 360	POA
CFW110312T4OYZ 160kW WEG VSDRIVE 312AMP 415V S Stop	ND HD	312 242	160 132	F	168	1200 x 430 x 360	POA
CFW110370T4OYZ 200kW WEG VSDRIVE 370AMP 415V S Stop	ND HD	370 312	200 160	F	168	1200 x 430 x 360	POA
CFW110477T4OYZ 260kW WEG VSDRIVE 477AMP 415V S Stop	ND HD	477 370	260 200	F	168	1200 x 430 x 360	POA
CFW110515T4OYZ 280kW WEG VSDRIVE 515AMP 415V S Stop	ND HD	515 477	280 260	G	258	1225 x 535 x 426	POA
CFW110601T4OYZ 330kW WEG VSDRIVE 601AMP 415V S Stop	ND HD	601 515	330 280	G	258	1225 x 535 x 426	POA
CFW110720T4OYZ 355kW WEG VSDRIVE 720AMP 415V S Stop	ND HD	720 560	355 300	G	258	1225 x 535 x 426	POA
CFW110760T4OYZ 355kW WEG VSDRIVE 760AMP 415V S Stop	ND HD	760 600	355 330	G	258	1225 x 535 x 426	POA
CFW110795T4OYZ 355kW WEG VSDRIVE 795AMP 415V S Stop							
CFW110877T4OYZ 450kW WEG VSDRIVE 877AMP 415V S Stop							
CFW111062T4OYZ 560kW WEG VSDRIVE 1062AMP 415V S Stop							
CFW111141T4OYZ 630kW WEG VSDRIVE 1141AMP 415V S Stop							
See AFW11 IP54 drives							

Prices Exclude GST and are subject to change at any time Ref: V24



CFW11 SYSTEM DRIVE - IP55 + STO

Product code / Description	Duty	Current	Motor	Frame Size	Weight	Dimensions H x W x D	Price NZ\$
230 V - 1 AC - Not In Stock		(A)	(kW)₂		Kg₁	(mm)	
CFW110006S2O55FADSZ 1.5kW WEG VSDRIVE 6AMP 230V 1PH IP55 + Switch N Duty	ND HD	6 6	1.5 1.5	B	17	529 x 273 x 279	4,370.00
CFW110007S2O55FADSZ 1.5kW WEG VSDRIVE 7AMP 230V 1PH IP55 + Switch N Duty	ND HD	7 7	1.5 1.5	B	17	529 x 273 x 279	4,509.00
CFW110010S2O55FADSZ 3kW WEG VSDRIVE 10AMP 230V 1PH IP55 + Switch N Duty	ND HD	10 10	3 3	B	17	529 x 273 x 279	4,747.00
380...480 V - 3AC	Duty	Amps	(kW)₂	Frame	Kg₁		NZ\$
EUCFW110003T4O55FADSYZ 1.5kW WEG VSDRIVE 3.6AMP 415V 3PH IP55 + Switch + S Stop N Duty	ND HD	3.6 3.6	1.5 1.5	B	17	529 x 273 x 279	4,353.00
EUCFW110010T4O55FADSYZ 4kW WEG VSDRIVE 10AMP 415V 3PH IP55 + Switch + S Stop N Duty	ND HD	10 10	4 4	B	17	529 x 273 x 279	4,783.00
EUCFW110013T4O55FADSYZ 5.5kW WEG VSDRIVE 13.5AMP 415V 3PH IP55 + Switch + S Stop N Duty	ND HD	13.5 11	5.5 5.5	B	17	529 x 273 x 279	5,256.00
EUCFW110017T4O55FADSYZ 7.5kW WEG VSDRIVE 17AMP 415V 3PH IP55 + Switch + S Stop N Duty	ND HD	17 13.5	7.5 5.5	B	17	529 x 273 x 279	5,829.00
EUCFW110024T4O55FADSYZ 11kW WEG VSDRIVE 24AMP 415V 3PH IP55 + Switch + S Stop N Duty	ND HD	24 19	11 9.2	B	17	529 x 273 x 279	6,585.00
EUCFW110038T4O55FADSYZ 18.5kW WEG VSDRIVE 38AMP 415V 3PH IP55 + Switch + S Stop N Duty	ND HD	38 33	18.5 15	C	30	670 x 307 x 348	9,114.00
EUCFW110045T4O55FADSYZ 22kW WEG VSDRIVE 45AMP 415V 3PH IP55 + Switch + S Stop N Duty	ND HD	45 38	22 18.5	C	30	670 x 307 x 348	10,096.00
EUCFW110058T4O55FADSYZ 30kW WEG VSDRIVE 58.5AMP 415V 3PH IP55 + Switch + S Stop N Duty	ND HD	58.5 47	30 22	C	30	670 x 307 x 348	11,932.00
EUCFW110070T4O55FADSYZ 37kW WEG VSDRIVE 70.5AMP 415V 3PH IP55 + Switch + S Stop N Duty	ND HD	70.5 61	37 30	D	49	754 x 375 x 301	14,573.00
EUCFW110088T4O55FADSYZ 45kW WEG VSDRIVE 88AMP 415V 3PH IP55 + Switch + S Stop N Duty	ND HD	88 73	45 37	D	49	754 x 375 x 301	POA
EUCFW110105T4O55DSYZ 55kW WEG VSDRIVE 105AMP 415V 3PH IP55 + Switch + S Stop N Duty	ND HD	105 88	55 45	E	96	1000 x 430 x 389	POA
EUCFW110142T4O55DSYZ 75kW WEG VSDRIVE 142AMP 415V 3PH IP55 + Switch + S Stop N Duty	ND HD	142 105	75 55	E	96	1000 x 430 x 389	POA
EUCFW110180T4O55DSYZ 90kW WEG VSDRIVE 180AMP 415V 3PH IP55 + Switch + S Stop N Duty	ND HD	180 142	90 75	E	96	1000 x 430 x 389	POA
EUCFW110211T4O55DSYZ 110kW WEG VSDRIVE 211AMP 415V 3PH IP55 + Switch + S Stop N Duty	ND HD	211 180	110 90	E	96	1000 x 430 x 389	POA



AFW11 SYSTEM DRIVE - IP54 + STO

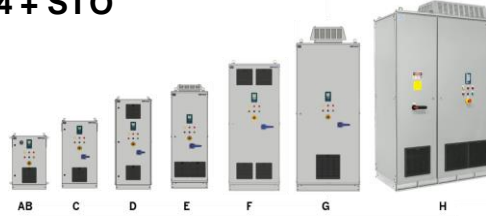

Product code / Description	Duty	Current A	Motor (2) kW	Panel Size	Weight (1) kg	Dimensions H x W x D	Price NZ\$
380...480 V - 3AC							
AFW110003T4OYZ	ND HD	3.6 3.6	1.5 1.5	AB	50	929 x 600 x 400	POA
1.5kW WEG VSDRIVE 3AMP 415V S Stop in IP54 Self Supported Panel							
AFW110005T4OYZ	ND HD	5 5	2.2 2.2	AB	50	929 x 600 x 400	POA
2.2kW WEG VSDRIVE 5AMP 415V S Stop in IP54 Self Supported Panel							
AFW110007T4OYZ	ND HD	7 5.5	3 2.2	AB	50	929 x 600 x 400	POA
3kW WEG VSDRIVE 7AMP 415V S Stop in IP54 Self Supported Panel							
AFW110010T4OYZ	ND HD	10 10	4 4	AB	52	929 x 600 x 400	POA
4kW WEG VSDRIVE 10AMP 415V S Stop in IP54 Self Supported Panel							
AFW110013T4OYZ	ND HD	13.5 11	5.5 5.5	AB	52	929 x 600 x 400	POA
5.5kW WEG VSDRIVE 13AMP 415V S Stop in IP54 Self Supported Panel							
AFW110017T4OYZ	ND HD	17 13.5	7.5 5.5	AB	65	929 x 600 x 400	POA
7.5kW WEG VSDRIVE 17AMP 415V S Stop in IP54 Self Supported Panel							
AFW110024T4OYZ	ND HD	24 19	11 9.2	AB	65	929 x 600 x 400	POA
11kW WEG VSDRIVE 24AMP 415V S Stop in IP54 Self Supported Panel							
AFW110031T4OYZ	ND HD	31 25	15 11	AB	65	929 x 600 x 400	POA
15kW WEG VSDRIVE 31AMP 415V S Stop in IP54 Self Supported Panel							
AFW110038T4OYZ	ND HD	38 33	18.5 15	C	105	1229 x 600 x 400	POA
18.5kW WEG VSDRIVE 38AMP 415V S Stop in IP54 Self Supported Panel							
AFW110045T4OYZ	ND HD	45 38	22 18.5	C	105	1229 x 600 x 400	POA
22kW WEG VSDRIVE 45AMP 415V S Stop in IP54 Self Supported Panel							
AFW110058T4OYZ	ND HD	58.5 47	30 22	C	105	1229 x 600 x 400	POA
30kW WEG VSDRIVE 58AMP 415V S Stop in IP54 Self Supported Panel							
AFW110070T4OYZ	ND HD	70.5 61	37 30	D	150	1629 x 600 x 400	POA
37kW WEG VSDRIVE 70AMP 415V S Stop in IP54 Self Supported Panel							
AFW110088T4OYZ	ND HD	88 73	45 37	D	150	1629 x 600 x 400	POA
45kW WEG VSDRIVE 88AMP 415V S Stop in IP54 Self Supported Panel							
AFW110105T4OYZ	ND HD	105 88	55 45	E	200	1727 x 600 x 600	POA
55kW WEG VSDRIVE 105AMP 415V S Stop in IP54 Self Supported Panel							
AFW110142T4OYZ	ND HD	142 115	75 55	E	200	1727 x 600 x 600	POA
75kW WEG VSDRIVE 142AMP 415V S Stop in IP54 Self Supported Panel							
AFW110180T OYZ	ND HD	180 142	90 75	E	200	1727 x 600 x 600	POA
90kW WEG VSDRIVE 180AMP 415V S Stop in IP54 Self Supported Panel							
AFW110211T4OYZ	ND HD	211 180	110 90	E	200	1727 x 600 x 600	POA
110kW WEG VSDRIVE 211AMP 415V S Stop in IP54 Self Supported Panel							
AFW110242T4OYZ	ND HD	242 211	132 110	F	300	2062 x 800 x 650	POA
132kW WEG VSDRIVE 242AMP 415V S Stop in IP54 Self Supported Panel							
AFW110312T4OYZ	ND HD	312 242	160 132	F	300	2062 x 800 x 650	POA
160kW WEG VSDRIVE 312AMP 415V S Stop in IP54 Self Supported Panel							
AFW110370T4OYZ	ND HD	370 312	200 160	F	300	2062 x 800 x 650	POA
200kW WEG VSDRIVE 370AMP 415V S Stop in IP54 Self Supported Panel							
AFW110477T4OYZ	ND HD	477 370	260 200	F	450	2062 x 800 x 650	POA
260kW WEG VSDRIVE 477AMP 415V S Stop in IP54 Self Supported Panel							
AFW110515T4OYZ	ND HD	515 477	280 260	G	550	2563 x 800 x 650	POA
280kW WEG VSDRIVE 515AMP 415V S Stop in IP54 Self Supported Panel							
AFW110601T4OYZ	ND HD	601 515	330 280	G	550	2563 x 800 x 650	POA
330kW WEG VSDRIVE 601AMP 415V S Stop in IP54 Self Supported Panel							
AFW110720T4OYZ	ND HD	720 560	355 300	G	550	2563 x 800 x 650	POA
355kW WEG VSDRIVE 720AMP 415V S Stop in IP54 Self Supported Panel							
AFW110760T4OYZ	ND HD	760 600	355 330	G	550	2563 x 800 x 650	POA
355kW WEG VSDRIVE 760AMP 415V S Stop in IP54 Self Supported Panel							
AFW110795T4OYZ	ND HD	795 637	355 355	H	1300	2563 x 1600 x 850	POA
355kW WEG VSDRIVE 795AMP 415V S Stop in IP54 Self Supported Panel							
AFW110877T4OYZ	ND HD	877 691	450 355	H	1250	2563 x 1600 x 850	POA
450kW WEG VSDRIVE 877AMP 415V S Stop in IP54 Self Supported Panel							
AFW111062T4OYZ	ND HD	1062 855	560 450	H	1350	2563 x 1600 x 850	POA
560kW WEG VSDRIVE 1062AMP 415V S Stop in IP54 Self Supported Panel							
AFW111141T4OYZ	ND HD	1141 943	630 500	H	1425	2563 x 1600 x 850	POA
630kW WEG VSDRIVE 1141AMP 415V S Stop in IP54 Self Supported Panel							

Prices Exclude GST and are subject to change at any time Ref: V24



CFW11 SYSTEM DRIVE ACCESSORIES

Part Number	Slot No.	Description	Price NZ\$
I/O Expansion Modules			
			
IOA-01	1	CFW-11 IOA Module: 1 analog inputs (14 bits, voltage or current); 2 digital inputs; 2 analog outputs (14 bits, voltage or current); 2 digital outputs (open-collector).	1,760.00
IOB-01	1	CFW11 IOB Module: 2 isolated analog inputs (12 bits, voltage or current); 2 digital inputs; 2 isolated analog outputs (11 bits, voltage or current); 2 digital outputs (open-collector).	1,072.00
IOC-01	1	CFW11 IOC Module: 8 Digital Inputs; 4 Digital Outputs (Use with Soft PLC)	850.00
IOC-02	1	CFW11 IOC Module: 8 Digital Inputs; 8 Open Collector Digital Outputs (Use with Soft PLC)	688.00
IOC-03	1	CFW11 IOC Module: 8 digital inputs 7 open collector digital outputs External 24 V dc (Use with Soft PLC)	688.00
Temperature Transducers Modules			
			
IOE-01	1	CFW11 5 PTC type temperature sensor Inputs	850.00
IOE-02	1	CFW11 5 PT100 type temperature sensor Inputs	2,860.00
IOE-03	1	CFW11 5 KTY84 type temperature sensor Inputs	1,417.00
Encoder Modules			
			
ENC-01	2	CFW11 Incremental encoder module, 5 to 12 VDC at 100 kHz, with encoder signal repeater.	769.00
ENC-02	2	CFW11 Incremental encoder module, 5 to 12 VDC at 100 kHz, without encoder signal repeater.	677.00
Communication Modules			
			
RS485-01	3	CFW11 RS-485C SERIAL COMMS RS485 (Modbus-RTU and BACnet)	353.00
RS232-01	3	CFW11 RS-232C SERIAL COMMS (MODBUS-RTU) CFW11	269.00
RS232-02	3	CFW11 RS-232C SERIAL COMMS WITH DIP-SWITCHES FOR MICROCONTROLLER'S FLASH MEMORY PROGRAMMING.	300.00
CAN/RS485-01	3	CFW11 CAN & RS-485 COMMS (CANopen, DeviceNet, Modbus-RTU and BACnet)	754.00
CAN-01	3	CAN INTERFACE COMMS (CANopen)	631.00
ETHERCAT-01	3	CFW11 ETHERCAT INTERFACE MODULE	3,091.00
PROFIBUSDP-01	3	CFW11 PROFIBUS DP COMMS	919.00
PROFDP-05	4	CFW11 PROFIBUS DP COMMS	2,713.00
DEVICENET-05	4	CFW11 DEVICENETCOMMS	2,713.00
ETHERNET/IP-05	4	CFW11 ETHERNET/IP INTERFACE MODULE - 1 PORT	2,713.00
ETHERNETIP-2P-05	4	CFW11 ETHERNET/IP INTERFACE MODULE - 2 PORTS	3,359.00
RS232-05	4	CFW11 RS-232C SERIAL COMMS (MODBUS RTU)	661.00
RS485-05	4	CFW11 RS-485C SERIAL COMMS (MODBUS RTU)	798.00
MODBUSTCP-05	4	CFW11 RS-485 Interface Module (MODBUS TCP) (Anybus)	2,942.00
PROFINETIO-05	4	PCFW11 Profinet IO Interface Module (Anybus)	2,360.00

Prices Exclude GST and are subject to change at any time Ref: V24



CFW11 SYSTEM DRIVE ACCESSORIES

Part Number	Slot No.	Description	Price NZ\$
PLC Module			
			
PLC11-01	1, 2, and 3	PLC functions; Ladder programming; 9 Bidirectional isolated Inputs 24V; 3 Bidirectional isolated open-collector outputs: 24Vdc, 500mA; 3 Outputs NO contacts: 250Vac, 3A; 2 Incremental Encoder Inputs 5...12Vdc, 500mA (internal power supply); 1 RS-485 port (Modbus RTU available); 1 CAN port (CANopen and Devicenet available); 1 Differential input: -10...+10Vdc / 0...20mA, 14 bits; 2 Analog outputs: -10...+10Vdc/ 0...20mA, 12 bits	3,358.00
PLC11-02	1, 2, and 3	PLC functions; Ladder programming; electronic gear box; 4 Bidirectional isolated Inputs 24V; 3 Bidirectional isolated open-collector outputs: 24Vdc, 500mA; 1 Outputs NO contacts: 250Vac, 3A; 2 Incremental Encoder Inputs 5...12Vdc, 500mA (internal power supply); 1 RS-485 port (Modbus RTU available); 1 CAN port (CANopen and Devicenet available)	2,759.00
Keypad Accessories			
			
HMI-01	-	CFW-11 keypad	530.00
RHMIF-01	-	CFW11 Frame for keypad remote assembly	101.00
HMID-01	-	CFW11 Blank cover for keypad slot	77.00
HMICAB-RS-1M	-	CFW11 Remote Keypad cable 1M	94.00
HMICAB-RS-2M	-	CFW11 Remote Keypad cable 2M	107.00
HMICAB-RS-3M	-	CFW11 Remote Keypad cable 3M	115.00
HMICAB-RS-5M	-	CFW11 Remote Keypad cable 5M	131.00
HMICAB-RS-7.5M	-	CFW11 Remote Keypad cable 7.5M	167.00
HMICAB-RS-10M	-	CFW11 Remote Keypad cable 10M	181.00
Conduit Kit			
			
KN1A-01	-	CFW11 Conduit kit for frame A (3,6 - 13,5)Amp	125.00
KN1B-01	-	CFW11 Conduit kit for frame B (17 - 31)Amp	145.00
KN1C-01	-	CFW11 Conduit kit for frame C (38 - 58,5)Amp	161.00
KN1E-02	-	CFW11 Conduit kit for frame E (105 - 211)Amp	417.00
KN1F-01	-	CFW11 Conduit kit for frame F (242 - 477)Amp	601.00
KN1G-01	-	CFW11 Conduit kit for frame G (515 - 760)Amp	685.00
Dynamic braking			
			
DBW03	-	CFW11 External Dynamic Braking Module for sizes F and G (380A - 380~480V)	11,777.00
External 24 VDC Power Supply			
W option 1		Additional price for 24 VDC power supply (Frame Sizes A,B,C and E)(Frame Size D on 200-240V and 380~480V)	1,469.00
W option 2		Additional price for 24 VDC power supply (Frame Sizes F and G)(Frame Size D on 500~690V)	1,806.00
STO Wiring			
CFW11-KSDC		CFW11 STO Cable Connection for CFW11 Y	46.00

Prices Exclude GST and are subject to change at any time Ref: V24

SSW07

The SSW07 is a compact high performance and simple-to-use soft starter.



Range 7.5kW to 220kW



415V Three Phase



IP20



Built-In Bypass Contactors



High Starting Duty



Thyristors Control on all Three Phases

SOFT STARTER - SSW07



- **Sizes:** 415V three phase
7.5kW (17A) up to 220kW (412A))
- Built-in bypass
- **Heavy Duty:**
Thermal Overload 300% for 30 sec
- Full electronic motor protection
- Kick start function to start loads with high static friction
- Electronic thermal relay
- Switched-mode power supply of the electronics with EMC filter (110 to 220 V)
- Thermal image (monitoring of the electronics voltage, allowing the backup of the current and voltage values)
- Simple electrical installation



- Interconnection with Fieldbus communication networks:
- Modbus-RTU and DeviceNet (optional)
- Human-Machine Interface - HMI (optional)
- Free SuperDrive G2 programming software
- 90...230V Control Power Supply required.

ACCESSORIES

Reference	Description
SSW07-08-HMI-LOC	Local Human-Machine Interface - HMI
SSW07-HMI-REM	Remote human-machine interface kit (HMI LED + HMI interface module) for SSW07
SSW08-HMI-REM	Remote human-machine interface kit (HMI LED + HMI interface module) for SSW08
CAB-RS-1M-SSW07/08	1 m cable to connect to remote HMI
CAB-RS-2M-SSW07/08	2 m cable to connect to remote HMI
CAB-RS-3M-SSW07/08	3 m cable to connect to remote HMI
CAB-RS-5M-SSW07/08	5 m cable to connect to remote HMI
CAB-RS-7,5M-SSW07/08	7.5 m cable to connect to remote HMI
CAB-RS-10M-SSW07/08	10 m cable to connect to remote HMI
HMI-SSW07-REM+RS485	Remote human-machine interface kit (HMI LED + HMI interface module) for SSW07
HMI-SSW08-REM+RS485	Remote human-machine interface kit (HMI LED + HMI interface module) for SSW08
SSW07-08-KRS-485	RS485 communication kit
KFB-DN-SSW07/08	DeviceNet communication module
SSW07-08-KRS-232	RS232 communication module
KRS232-SSW07/08	RS232 communication module and cable kit
CAB-SER-3M-SSW07/08	3 m cable for serial connection to PC
CAB-SER-10M-SSW07/08	10 m cable for serial connection to PC
SSW07/08/900-KVT-2B	Ventilation kit for frame 2 (currents from 45 to 85 A)
SSW07/08/900-KVT-3C	Ventilation kit for frame 3 (currents from 130 to 200 A)
SSW07-08-KPTC-MTR	Motor PTC module
SSW07/08/900-IP20-3C	IP20 kit for frame 3 (currents from 130 to 200 A)
SSW07/08/900-IP20-4D	IP20 kit for frame 4 (currents from 255 to 412 A)







SSW07 SOFT STARTER - IP20

SSW07 380V / 400V - 3AC						
Product code / Description	Current (A)	Motor (kW)	Frame Size	Weight (Kg)	Dimensions H x W x D (mm)	Price NZ\$
SSW070017T5SZ 7.5kW WEG SOFT STARTER 17AMP 220-575V	17	7.5	1	1.3	162 x 95 x 157	2,105.00
SSW070024T5SZ 11kW WEG SOFT STARTER 24AMP 220-575V	24	11	1	1.3	162 x 95 x 157	2,260.00
SSW070030T5SZ 15kW WEG SOFT STARTER 30AMP 220-575V	30	15	1	1.3	162 x 95 x 157	2,332.00
SSW070045T5SZ 22kW WEG SOFT STARTER 45AMP 220-575V	45	22	2	3.3	209 x 141 x 202	2,665.00
SSW070061T5SZ 30kW WEG SOFT STARTER 61AMP 220-575V	61	30	2	3.3	209 x 141 x 202	3,151.00
SSW070085T5SZ 45kW WEG SOFT STARTER 85AMP 220-575V	85	45	2	3.3	209 x 141 x 202	3,624.00
SSW070130T5OIPZ 55kW WEG SOFT STARTER 130AMP 220-575V	130	55	3	7.6	276 x 218 x 220	4,661.00
SSW070171T5OIPZ 90kW WEG SOFT STARTER 171AMP 220-575V	171	90	3	7.6	276 x 218 x 220	5,896.00
SSW070200T5OIPZ 110kW WEG SOFT STARTER 200AMP 220-575V	200	110	3	7.6	276 x 218 x 220	6,968.00
SSW070255T5OIPH2Z 132kW WEG SOFT STARTER 255AMP 220-575V	255	132	4	11.5	331 x 227 x 242	9,853.00
SSW070312T5OIPH2Z 160kW WEG SOFT STARTER 312AMP 220-575V	312	160	4	11.5	331 x 227 x 242	10,457.00
SSW070365T5OIPH2Z 200kW WEG SOFT STARTER 365AMP 220-575V	365	200	4	11.5	331 x 227 x 242	10,621.00
SSW070412T5OIPH2Z 220kW WEG SOFT STARTER 412AMP 220-575V	412	220	4	11.5	331 x 227 x 242	12,359.00



SSW07 SOFT STARTER ACCESSORIES

Product code	Description	Price NZ\$
HMI		
HMI-Local-SSW07	SSW07 Keypad	313.00
HMI-Remote-SSW07	SSW07 Remote Keypad Kit	572.00
Cables for HMI		
CAB-RS-1	SSW07 Cable for Serial Keypad - 1m	37.00
CAB-RS-2	SSW07 Cable for Serial Keypad - 2m	51.00
CAB-RS-3	SSW07 Cable for Serial Keypad - 3m	61.00
CAB-RS-5	SSW07 Cable for Serial Keypad - 5m	79.00
CAB-RS-7.5	SSW07 Cable for Serial Keypad - 7.5m	93.00
CAB-RS-10	SSW07 Cable for Serial Keypad - 10m	107.00
Ventilation Kit		
Ventilation Kit M2	SSW07 Ventilation Kit M2 (45 to 85 A)	105.00
Ventilation Kit M3	SSW07 Ventilation Kit M3 (130 to 200 A)	158.00
PTC Kit		
KIT PTC SSW07 MOTOR	SSW07 PTC Kit for motor	231.00
Superdrive Kit		
KSDG2 SSW07	SSW07 Superdrive G2 Kit (KRS-232-SSW07+CAB-RS-3+CD Softwa	Laptop not included 383.00

SSW900

This new innovative soft starter offers complete motor protection and start/stop control. The operating interface enables unprecedented user interactivity and parameter setting.



Range 4kW to 355kW



415V Three Phase



IP20



Fire Mode



SoftPLC Built-In



Thermistor Input Built-In



PT100 Expansion Module Available

SOFT STARTER - SSW900



- **Sizes:** 415V three phase
4kW (10A) up to 750kW (1400A)
- **Overload capacity:**
300% for 30 seconds, 10 Starts hour
- Super easy setup via "Oriented Startup"
- Option of standard connection (3 cables) or motor inside delta connection (6 cables)* Inside Delta connection able
(Current sizing = $I_n \times 1.732$)
- Elimination of mechanical shocks
- Pump control function:
Smart control of pumping systems that prevent water hammer and pressure overshoots in the hydraulic piping



- Integral motor thermal protection
- Longer lifespan of the motor and equipment
Limitation of voltage drops at the start
- Operation at ambient temperature up to 55 °C without current derating (Frame size A to D)
- Three braking methods to stop the motor and the load faster
- Built-in bypass in the whole range

ACCESSORIES

Accessory	Description	Image
Accessories for communication and control - Slots 1 and 2		
SSW900-CAN-W	CANopen and DeviceNet communication plug-in module	
SSW900-CRS485-W	Modbus-RTU communication plug-in module	
SSW900-CDN-N	DeviceNet - Anybus communication plug-in module	
SSW900-CPDP-N	Profibus-DP - Anybus communication plug-in module	
SSW900-CETH-IP-N	EtherNet/IP - Anybus communication plug-in module	
SSW900-CMB-TCP-N	Modbus-TCP - Anybus communication plug-in module	
SSW900-CPN-IO-N	PROFINET IO - Anybus communication plug-in module	
SSW900-CETH-W ¹⁾	Ethernet/IP communication plug-in module	
SSW900-HMI-BLT	Remote operating interface with Bluetooth communication	
SSW900-PT100-W	Temperature plug-in module for PT100 sensors - 6 channels	
Accessories for mechanical installation		
SSW900-KVT-02	Ventilation kit for frame B (currents from 45 to 105 A)	
SSW900-KVT-03	Ventilation kit for frame C (currents from 130 to 200 A)	
SSW900-KIP-03	IP20 kit for frame C (currents from 130 to 200 A)	
SSW900-KIP-04	IP20 kit for frame D (currents from 255 to 412 A)	
SSW900-PROT-M3	Front cover kit for power terminals of frame C (currents from 130 to 200 A)	
SSW900-PROT-M4	Front cover kit for power terminals of frame D (currents from 255 to 412 A)	
SSW900-PROT-M5	Front cover kit for power terminals of frame E (currents from 480 to 670 A)	

SSW900 - FULL MOTOR CONTROL AND PROTECTION

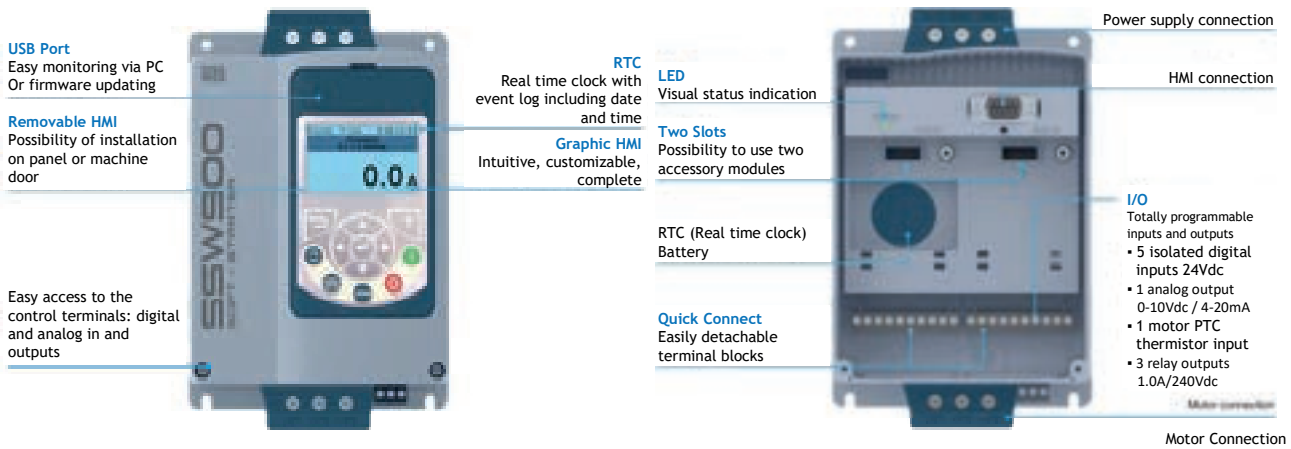

Frame Size E and up

This soft starter can be connected In either way

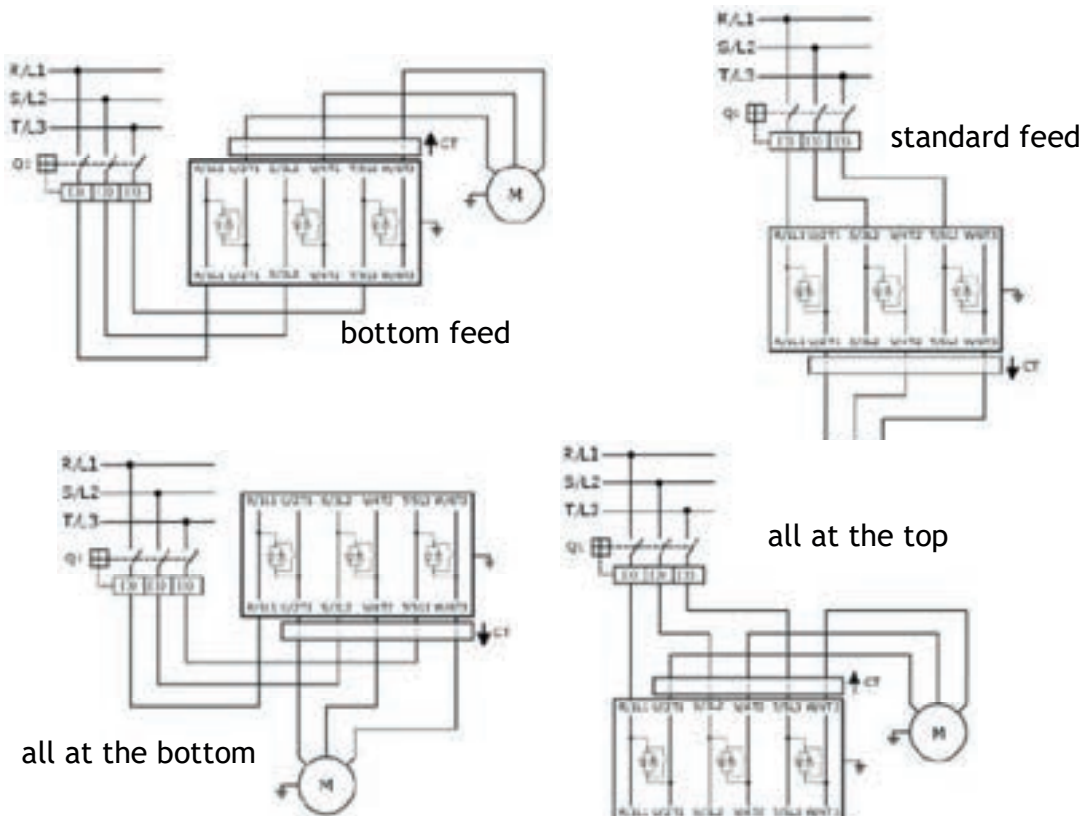



SSW900 SOFT STARTER - IP20

SSW900 220 - 575 V - 3AC						
Product code / Description	Current (A)	Motor (kW)	Frame Size	Weight (Kg)	Dimensions H x W x D (mm)	Price NZ\$
SSW900A0010T5E2 SSW900 4kW WEG SOFT STARTER 10AMP 220-575V	10	4	A	1.93	200 x 127 x 203	2,749.00
SSW900A0017T5E2 SSW900 7.5kW WEG SOFT STARTER 17AMP 220-575V	17	7.5	A	1.93	200 x 127 x 203	3,253.00
SSW900A0024T5E2 SSW900 11kW WEG SOFT STARTER 24AMP 220-575V	24	11	A	1.93	200 x 127 x 203	3,489.00
SSW900A0030T5E2 SSW900 15kW WEG SOFT STARTER 30AMP 220-575V	30	15	A	1.93	200 x 127 x 203	3,803.00
SSW900B0045T5E2 SSW900 22kW WEG SOFT STARTER 45AMP 220-575V	45	22	B	4.02	208 x 144 x 260	4,477.00
SSW900B0061T5E2 SSW900 30kW WEG SOFT STARTER 61AMP 220-575V	61	30	B	4.02	208 x 144 x 260	4,896.00
SSW900B0085T5E2 SSW900 45kW WEG SOFT STARTER 85AMP 220-575V	85	45	B	4.02	208 x 144 x 260	5,230.00
SSW900B0105T5E2 SSW900 55kW WEG SOFT STARTER 105AMP 220-575V	105	55	B	4.02	208 x 144 x 260	5,494.00
SSW900C0130T5E2 SSW900 55kW WEG SOFT STARTER 130AMP 220-575V*	130	55	C	6.55	383 x 233 x 262	6,210.00
SSW900C0171T5E2 SSW900 90kW WEG SOFT STARTER 171AMP 220-575V*	171	90	C	6.55	383 x 233 x 262	7,600.00
SSW900C0200T5E2 SSW900 110kW WEG SOFT STARTER 200AMP 220-575V*	200	110	C	6.55	383 x 233 x 262	9,559.00
SSW900D0255T5E4 SSW900 132kW WEG SOFT STARTER 255AMP 220-575V*	255	132	D	12.83	480 x 230 x 285	13,241.00
SSW900D0312T5E4 SSW900 160kW WEG SOFT STARTER 312AMP 220-575V*	312	160	D	12.83	480 x 230 x 285	14,047.00
SSW900D0365T5E4 SSW900 200kW WEG SOFT STARTER 365AMP 220-575V*	365	200	D	12.83	480 x 230 x 285	14,268.00
SSW900D0412T5E4 SSW900 220kW WEG SOFT STARTER 412AMP 220-575V*	412	220	D	12.83	480 x 230 x 285	16,604.00
SSW900E0480T5E4 SSW900 260kW WEG SOFT STARTER 480AMP 220-575V*	480	260	E	38	685 x 390 x 260	20,621.00
SSW900E0604T5E4 SSW900 330kW WEG SOFT STARTER 604AMP 220-575V*	604	330	E	38	685 x 390 x 260	22,863.00
SSW900E0670T5E4 SSW900 355kW WEG SOFT STARTER 670AMP 220-575V*	670	355	E	38	685 x 390 x 260	26,213.00
SSW900F0820T5E4 SSW900 410kW WEG SOFT STARTER 820AMP 220-575V*	820	410	F	75.4	760 x 464 x 316	33,730.00
SSW900F0950T5E4 SSW900 550kW WEG SOFT STARTER 950AMP 220-575V*	950	550	F	75.4	760 x 464 x 316	POA
SSW900G1100T5E4 SSW900 600kW WEG SOFT STARTER 1100AMP 220-575V*	1100	600	G	107.2	914 x 539 x 316	POA
SSW900G1400T5E4 SSW900 750kW WEG SOFT STARTER 1400AMP 220-575V*	1400	750	G	107.2	914 x 539 x 316	POA

Prices Exclude GST and are subject to change at any time Ref: V24



SSW900 SOFT STARTER ACCESSORIES

Product code	Description	Price NZ\$
Cable + HMI		
	 keypad not included	
SSW900-KMD-CB01	SSW900 Remote Keypad Frame + 1m (3.3ft) Cable	128.00
SSW900-KMD-CB02	SSW900 Remote Keypad Frame + 2m (6.6ft) Cable	144.00
SSW900-KMD-CB03	SSW900 Remote Keypad Frame + 3m (10ft) Cable	162.00
SSW900-KMD-CB05	SSW900 Remote Keypad Frame + 5m (16ft) Cable	219.00
SSW900-KMD-CB07	SSW900 Remote Keypad Frame + 7.5m (26ft) Cable	300.00
SSW900-KMD-CB10	SSW900 Remote Keypad Frame + 10m (33ft) Cable	376.00
SSW900-KMD-CB20	SSW900 Remote Keypad Frame + 20m (66ft) Cable	690.00
PT100		
		
SSW900-PT100-W	SSW900-PT100-W	684.00
Communication Plug-in Modules		
		
SSW900-CDN-N	SSW900 Devicenet Anybus plug-in module	2,590.00
SSW900-CETH-IP-N	SSW900 Ethernet/IP Anybus plug-in module	3,758.00
SSW900-CMB-TCP-N	SSW900 Modbus-TCP Anybus plug-in module	2,927.00
SSW900-CPDP-N	SSW900 Profibus DP Anybus plug-in module	2,376.00
SSW900-CPN-IO-N	SSW900 Profinet IO Anybus plug-in module	3,350.00
SSW900-CRS485-W	SSW900 RS485 plug-in module	343.00
SSW900-CAN-W	SSW900 CANopen and DeviceNet plug-in module	656.00
SSW900-CETH-W	SSW900 Ethernet/IP plug-in module (Availability 2020)	2,476.00
IP20 Kit		
		
SSW0708900-IP20-3C	SSW07/SSW900 IP20 Kit for SSW900 frame size C or SSW07 frame size 3 (130 up to 200 A)	122.00
SSW0708900-IP20-4D	SSW07/SSW900 IP20 Kit for SSW900 frame size D or SSW07 frame size 4 (225 up to 412 A)	228.00
Front Cover Kit		
SSW900-KPT-MEC03/C	Front cover kit for power terminals for SSW900 frame C (130 to 200 A)	112.00
SSW900-KPT-MEC04/D	Front cover kit for power terminals for SSW900 frame D (255 to 412 A)	146.00
SSW900-KPT-MECE	Front cover kit for power terminals for SSW900 frame E (480 to 670 A)	279.00
Ventilation Kit		
SSW900-KVT-02	SSW900 Ventilation Kit frame size B (45 to 105 A)	152.00
SSW900-KVT-03	SSW900 Ventilation Kit frame size C (130 to 200 A)	215.00
Bus Bar Kit		
SSW900-6BAR-E	Bus Bar Kit with six bars for SSW900 frame E (480 to 670 A)	684.00
SSW900-6BAR-F	Bus Bar Kit with six bars for SSW900 frame F (820 to 950 A)	853.00
SSW900-3BAR-G	Bus Bar Kit with six bars for SSW900 frame G (1100 to 1400 A)	1,011.00
External Current Transformer		
SSW900-KECA-10	SSW900 External Current Transformer for SSW900 10A	582.00
SSW900-KECA-17	SSW900 External Current Transformer for SSW900 17A	612.00
SSW900-KECA-24	SSW900 External Current Transformer for SSW900 24A	641.00
SSW900-KECA-30	SSW900 External Current Transformer for SSW900 30A	670.00
SSW900-KECA-45	SSW900 External Current Transformer for SSW900 45A	698.00
SSW900-KECA-61	SSW900 External Current Transformer for SSW900 61A	727.00
SSW900-KECA-85	SSW900 External Current Transformer for SSW900 85A	757.00
SSW900-KECA-105	SSW900 External Current Transformer for SSW900 105A	785.00
SSW900-KECA-130	SSW900 External Current Transformer for SSW900 130A	815.00
SSW900-KECA-171	SSW900 External Current Transformer for SSW900 171A	844.00
SSW900-KECA-200	SSW900 External Current Transformer for SSW900 200A	873.00
SSW900-KECA-255	SSW900 External Current Transformer for SSW900 255A	1,020.00
SSW900-KECA-312	SSW900 External Current Transformer for SSW900 312A	1,078.00
SSW900-KECA-365	SSW900 External Current Transformer for SSW900 365A	1,136.00
SSW900-KECA-412	SSW900 External Current Transformer for SSW900 412A	1,165.00

Prices Exclude GST and are subject to change at any time Ref: V24

CONTROLS

MOTOR STARTERS AND PROTECTION

CWB CONTACTORS
CWC CONTACTORS
CWM CONTACTORS
RW OVERLOAD RELAYS
ELECTRONIC OVERLOAD RELAYS
MPW MOTOR CIRCUIT BREAKERS

DOL STARTERS
ELECTRONIC RELAYS
SRW SMART RELAYS
POWER METERS
ENCLOSURES

PUSHBUTTONS & PILOT LIGHTS

CIRCUIT PROTECTION

MINIATURE AND RESIDUAL CURRENT CIRCUIT BREAKERS
FNH FUSES
MSW ISOLATOR SWITCH
ACW MOULDED CASE CIRCUIT BREAKERS

CAPACITORS

POWER FACTOR CORRECTION CAPACITORS
CWBC AND CWMC CONTACTORS

TERMINAL BLOCKS

INTERFACE RELAYS
TERMINAL BLOCKS

CWB CONTACTORS



Modular and compact



Suitable for different applications



Simplified Installation



Highly reliable



Internationally recognised quality





Energy Saving



CWB Series

- CWB Contactors

WEG CWB Contactors are modular and compact but at the same time robust and highly reliable. Easy installation and energy savings meet the expectations of users who want to perform automation in a more simple and practical way. AC-3 rating

	Item number	Description	SAP number	Trade Price	Contractor Price
	CWB9-11-30D25	9A 3-Pole CWB Contactor (240Vac coil)	12679516	\$184.61	\$81.23
	CWB12-11-30D25	12A 3-Pole CWB Contactor (240Vac coil)	12679520	\$196.02	\$86.25
	CWB18-11-30D25	18A 3-Pole CWB Contactor (240Vac coil)	12679526	\$271.20	\$119.33
	CWB25-11-30D25	25A 3-Pole CWB Contactor (240Vac coil)	12679551	\$362.50	\$159.50
	CWB32-11-30D25	32A 3-Pole CWB Contactor (240Vac coil)	12679556	\$441.72	\$194.36
	CWB38-11-30D25	38A 3-Pole CWB Contactor (240Vac coil)	12679560	\$522.27	\$229.80
	CWB40-11-30D25	40A 3-Pole CWB Contactor (240Vac coil)	13543411	\$597.14	\$262.74
	CWB50-11-30D25	50A 3-Pole CWB Contactor (240Vac coil)	13860294	\$865.97	\$381.03
	CWB65-11-30D25	65A 3-Pole CWB Contactor (240Vac coil)	13860295	\$908.95	\$399.94
	CWB80-11-30D25	80A 3-Pole CWB Contactor (240Vac coil)	13860340	\$1,244.58	\$547.62
	CWB95-11-30E65	95A 3-Pole CWB Contactor (110-255Vac/dc coil)	14806030	\$1,541.11	\$678.09
	CWB110-11-30E65	110A 3-Pole CWB Contactor (110-255Vac/dc coil)	14806033	\$1,702.10	\$748.92
	CWB125-11-30E65	125A 3-Pole CWB Contactor (110-255Vac/dc coil)	14806036	\$1,997.14	\$878.74
	CWB9-11-30D35	9A 3-Pole CWB Contactor (415Vac coil)	12772077	\$184.61	\$81.23
	CWB12-11-30D35	12A 3-Pole CWB Contactor (415Vac coil)	12772149	\$196.02	\$86.25
	CWB18-11-30D35	18A 3-Pole CWB Contactor (415Vac coil)	12772151	\$271.20	\$119.33
	CWB25-11-30D35	25A 3-Pole CWB Contactor (415Vac coil)	12868167	\$362.50	\$159.50
	CWB32-11-30D35	32A 3-Pole CWB Contactor (415Vac coil)	12868229	\$441.72	\$194.36
	CWB38-11-30D35	38A 3-Pole CWB Contactor (415Vac coil)	12868230	\$522.27	\$229.80
	CWB40-11-30D35	40A 3-Pole CWB Contactor (415Vac coil)	13860410	\$597.14	\$262.74
	CWB50-11-30D35	50A 3-Pole CWB Contactor (415Vac coil)	13860411	\$865.97	\$381.03
	CWB65-11-30D35	65A 3-Pole CWB Contactor (415Vac coil)	13860412	\$908.95	\$399.94
	CWB80-11-30D35	80A 3-Pole CWB Contactor (415Vac coil)	13860414	\$1,244.58	\$547.62
	CWB95-11-30E66	95A 3-Pole CWB Contactor (250-500Vac/dc coil)	16041846	\$1,541.11	\$678.09
	CWB110-11-30E66	110A 3-Pole CWB Contactor (250-500Vac/dc coil)	16041918	\$1,702.10	\$748.92
	CWB125-11-30E66	125A 3-Pole CWB Contactor (250-500Vac/dc coil)	16041919	\$1,997.14	\$878.74
	CWB9-11-30D13	9A 3-Pole CWB Contactor (110Vac coil)	12660801	\$184.61	\$81.23
	CWB12-11-30D13	12A 3-Pole CWB Contactor (110Vac coil)	12660804	\$196.02	\$86.25
	CWB18-11-30D13	18A 3-Pole CWB Contactor (110Vac coil)	12660807	\$271.20	\$119.33
	CWB25-11-30D13	25A 3-Pole CWB Contactor (110Vac coil)	12232934	\$362.50	\$159.50
	CWB32-11-30D13	32A 3-Pole CWB Contactor (110Vac coil)	12240798	\$441.72	\$194.36
	CWB38-11-30D13	38A 3-Pole CWB Contactor (110Vac coil)	12233028	\$522.27	\$229.80
	CWB40-11-30D13	40A 3-Pole CWB Contactor (110Vac coil)	13851360	\$597.14	\$262.74
	CWB50-11-30D13	50A 3-Pole CWB Contactor (110Vac coil)	13851365	\$865.97	\$381.03
	CWB65-11-30D13	65A 3-Pole CWB Contactor (110Vac coil)	13851367	\$908.95	\$399.94
	CWB80-11-30D13	80A 3-Pole CWB Contactor (110Vac coil)	13851448	\$1,244.58	\$547.62
	CWB95-11-30E65	95A 3-Pole CWB Contactor (110-255Vac/dc coil)	14806030	\$1,541.11	\$678.09
	CWB110-11-30E65	110A 3-Pole CWB Contactor (110-255Vac/dc coil)	14806033	\$1,702.10	\$748.92
	CWB125-11-30E65	125A 3-Pole CWB Contactor (110-255Vac/dc coil)	14806036	\$1,997.14	\$878.74



Contractor

Other Coil Voltages available on request



- CWB Contactors

WEG CWB Contactors are modular and compact but at the same time robust and highly reliable. Easy installation and energy savings meet the expectations of users who want to perform automation in a more simple and practical way. AC-3 rating

	Item number	Description	SAP number	Trade Price	Contractor Price	
	CWB9-11-30D02	9A 3-Pole CWB Contactor (24Vac coil)	12660800	\$184.61	\$81.23	
	CWB12-11-30D02	12A 3-Pole CWB Contactor (24Vac coil)	12660803	\$196.02	\$86.25	
	CWB18-11-30D02	18A 3-Pole CWB Contactor (24Vac coil)	12660806	\$271.20	\$119.33	
	CWB25-11-30D02	25A 3-Pole CWB Contactor (24Vac coil)	12232932	\$362.50	\$159.50	
	CWB32-11-30D02	32A 3-Pole CWB Contactor (24Vac coil)	12240777	\$441.72	\$194.36	
	CWB38-11-30D02	38A 3-Pole CWB Contactor (24Vac coil)	12232937	\$522.27	\$229.80	
	CWB40-11-30D02	40A 3-Pole CWB Contactor (24Vac coil)	13543410	\$597.14	\$262.74	
	CWB50-11-30D02	50A 3-Pole CWB Contactor (24Vac coil)	13851363	\$865.97	\$381.03	
	CWB65-11-30D02	65A 3-Pole CWB Contactor (24Vac coil)	13851366	\$908.95	\$399.94	
	CWB80-11-30D02	80A 3-Pole CWB Contactor (24Vac coil)	13860240	\$1,244.58	\$547.62	
	CWB95-11-30E04	95A 3-Pole CWB Contactor (24-60 Vac/dc coil)	15477392	\$1,541.11	\$678.09	
	CWB110-11-30E04	110A 3-Pole CWB Contactor (24-60 Vac/dc coil)	15477393	\$1,702.10	\$748.92	
	CWB125-11-30E04	125A 3-Pole CWB Contactor (24-60 Vac/dc coil)	15477390	\$1,997.14	\$878.74	
		CWB9-11-30C03	9A 3-Pole CWB Contactor (24Vdc coil)	12542197	\$249.07	\$109.59
		CWB12-11-30C03	12A 3-Pole CWB Contactor (24Vdc coil)	12542260	\$261.15	\$114.91
CWB18-11-30C03		18A 3-Pole CWB Contactor (24Vdc coil)	12542266	\$339.69	\$149.46	
CWB25-11-30C03		25A 3-Pole CWB Contactor (24Vdc coil)	12240635	\$429.64	\$189.04	
CWB32-11-30C03		32A 3-Pole CWB Contactor (24Vdc coil)	12240801	\$508.85	\$223.89	
CWB38-11-30C03		38A 3-Pole CWB Contactor (24Vdc coil)	12240668	\$588.06	\$258.75	
CWB40-11-30C03		40A 3-Pole CWB Contactor (24Vdc coil)	13538738	\$930.42	\$409.38	
CWB50-11-30C03		50A 3-Pole CWB Contactor (24Vdc coil)	13539286	\$1,064.74	\$468.49	
CWB65-11-30C03		65A 3-Pole CWB Contactor (24Vdc coil)	13539299	\$1,284.87	\$565.34	
CWB80-11-30C03		80A 3-Pole CWB Contactor (24Vdc coil)	13428645	\$1,650.06	\$726.03	
CWB95-11-30E04		95A 3-Pole CWB Contactor (24-60 Vac/dc coil)	15477392	\$1,541.11	\$678.09	
CWB110-11-30E04		110A 3-Pole CWB Contactor (24-60 Vac/dc coil)	15477393	\$1,702.10	\$748.92	
CWB125-11-30E04		125A 3-Pole CWB Contactor (24-60 Vac/dc coil)	15477390	\$1,997.14	\$878.74	
		CWB9-11-30C07	9A 3-Pole CWB Contactor (48Vdc coil)	12679563	\$249.07	\$109.59
		CWB12-11-30C07	12A 3-Pole CWB Contactor (48Vdc coil)	12679565	\$261.15	\$114.91
	CWB18-11-30C07	18A 3-Pole CWB Contactor (48Vdc coil)	12679566	\$339.69	\$149.46	
	CWB25-11-30C07	25A 3-Pole CWB Contactor (48Vdc coil)	12679567	\$429.64	\$189.04	
	CWB32-11-30C07	32A 3-Pole CWB Contactor (48Vdc coil)	12679569	\$508.85	\$223.89	
	CWB38-11-30C07	38A 3-Pole CWB Contactor (48Vdc coil)	12679568	\$588.06	\$258.75	
	CWB40-11-30C07	40A 3-Pole CWB Contactor (48Vdc coil)	14151138	\$930.42	\$409.38	
	CWB50-11-30C07	50A 3-Pole CWB Contactor (48Vdc coil)	14151139	\$1,064.74	\$468.49	
	CWB65-11-30C07	65A 3-Pole CWB Contactor (48Vdc coil)	14151142	\$1,284.87	\$565.34	
	CWB80-11-30C07	80A 3-Pole CWB Contactor (48Vdc coil)	14151146	\$1,650.06	\$726.03	
	CWB95-11-30E64	95A 3-Pole CWB Contactor (48-130Vac/dc coil)	16051995	\$1,541.11	\$678.09	
	CWB110-11-30E64	110A 3-Pole CWB Contactor (48-130Vac/dc coil)	16051997	\$1,702.10	\$748.92	
	CWB125-11-30E64	125A 3-Pole CWB Contactor (48-130Vac/dc coil)	16052048	\$1,997.14	\$878.74	

Contractor

Other Coil Voltages available on request



CWB Series

- CWB Contactors - 4 Pole

WEG CWB Contactors are modular and compact but at the same time robust and highly reliable. Easy installation and energy savings meet the expectations of users who want to perform automation in a more simple and practical way. AC-1 or AC-3 rating

Item number	Description	SAP number	Trade Price	Contractor Price
CWB9-11-40D02	9A (25A AC1) 4-Pole CWB Contactor (24Vac coil) (4NO)	15777926	\$275.25	\$121.11
CWB12-11-40D02	12A (25A AC1) 4-Pole CWB Contactor (24Vac coil) (4NO)	15778408	\$288.73	\$127.04
CWB18-11-40D02	18A (32A AC1) 4-Pole CWB Contactor (24Vac coil) (4NO)	15778410	\$316.77	\$139.38
CWB9-11-22D02	9A (25A AC1) 4-Pole CWB Contactor (24Vac coil) (2NO + 2NC)	15778413	\$275.25	\$121.11
CWB12-11-22D02	12A (25A AC1) 4-Pole CWB Contactor (24Vac coil) (2NO + 2NC)	15778528	\$288.73	\$127.04
CWB18-11-22D02	18A (32A AC1) 4-Pole CWB Contactor (24Vac coil) (2NO + 2NC)	15778529	\$316.77	\$139.38
CWB9-11-04D02	9A (25A AC1) 4-Pole CWB Contactor (24Vac coil) (4NC)	15778530	\$275.25	\$121.11
CWB12-11-04D02	12A (25A AC1) 4-Pole CWB Contactor (24Vac coil) (4NC)	15778531	\$288.73	\$127.04
CWB18-11-04D02	18A (32A AC1) 4-Pole CWB Contactor (24Vac coil) (4NC)	15778532	\$316.77	\$139.38
CWB9-11-40D25	9A (25A AC1) 4-Pole CWB Contactor (240Vac coil) (4NO)	15780458	\$275.25	\$121.11
CWB12-11-40D25	12A (25A AC1) 4-Pole CWB Contactor (240Vac coil) (4NO)	15780460	\$288.73	\$127.04
CWB18-11-40D25	18A (32A AC1) 4-Pole CWB Contactor (240Vac coil) (4NO)	15780461	\$316.77	\$139.38
CWB9-11-22D25	9A (25A AC1) 4-Pole CWB Contactor (240Vac coil) (2NO + 2NC)	15780463	\$275.25	\$121.11
CWB12-11-22D25	12A (25A AC1) 4-Pole CWB Contactor (240Vac coil) (2NO + 2NC)	15780465	\$288.73	\$127.04
CWB18-11-22D25	18A (32A AC1) 4-Pole CWB Contactor (240Vac coil) (2NO + 2NC)	15780466	\$316.77	\$139.38
CWB9-11-04D25	9A (25A AC1) 4-Pole CWB Contactor (240Vac coil) (4NC)	15780488	\$275.25	\$121.11
CWB12-11-04D25	12A (25A AC1) 4-Pole CWB Contactor (240Vac coil) (4NC)	15780489	\$288.73	\$127.04
CWB18-11-04D25	18A (32A AC1) 4-Pole CWB Contactor (240Vac coil) (4NC)	15780491	\$316.77	\$139.38
CWB9-11-40D35	9A (25A AC1) 4-Pole CWB Contactor (415Vac coil) (4NO)	15780616	\$275.25	\$121.11
CWB12-11-40D35	12A (25A AC1) 4-Pole CWB Contactor (415Vac coil) (4NO)	15780617	\$288.73	\$127.04
CWB18-11-40D35	18A (32A AC1) 4-Pole CWB Contactor (415Vac coil) (4NO)	15780678	\$316.77	\$139.38
CWB9-11-22D35	9A (25A AC1) 4-Pole CWB Contactor (415Vac coil) (2NO + 2NC)	15780679	\$275.25	\$121.11
CWB12-11-22D35	12A (25A AC1) 4-Pole CWB Contactor (415Vac coil) (2NO + 2NC)	15780680	\$288.73	\$127.04
CWB18-11-22D35	18A (32A AC1) 4-Pole CWB Contactor (415Vac coil) (2NO + 2NC)	15780681	\$316.77	\$139.38
CWB9-11-04D35	9A (25A AC1) 4-Pole CWB Contactor (415Vac coil) (4NC)	15780682	\$275.25	\$121.11
CWB12-11-04D35	12A (25A AC1) 4-Pole CWB Contactor (415Vac coil) (4NC)	15780683	\$288.73	\$127.04
CWB18-11-04D35	18A (32A AC1) 4-Pole CWB Contactor (415Vac coil) (4NC)	15780684	\$316.77	\$139.38
CWB9-11-40C03	9A (25A AC1) 4-Pole CWB Contactor (24Vdc coil) (4NO)	15595901	\$386.82	\$170.20
CWB12-11-40C03	12A (25A AC1) 4-Pole CWB Contactor (24Vdc coil) (4NO)	15595902	\$419.90	\$184.76
CWB18-11-40C03	18A (32A AC1) 4-Pole CWB Contactor (24Vdc coil) (4NO)	15238077	\$805.56	\$354.45
CWB9-11-22C03	9A (25A AC1) 4-Pole CWB Contactor (24Vdc coil) (2NO + 2NC)	15625405	\$386.82	\$170.20
CWB12-11-22C03	12A (25A AC1) 4-Pole CWB Contactor (24Vdc coil) (2NO + 2NC)	15625406	\$419.90	\$184.76
CWB18-11-22C03	18A (32A AC1) 4-Pole CWB Contactor (24Vdc coil) (2NO + 2NC)	15625347	\$805.56	\$354.45

Contractor

Other Coil Voltages available on request



CWB Series

- CWB Contactors Accessories

WEG CWB Contactors are modular and compact but at the same time robust and highly reliable. Easy installation and energy savings meet the expectations of users who want to perform automation in a more simple and practical way. AC-3 rating

Item number	Description	SAP number	Trade Price	Contractor Price
BFB-11	Auxiliary Contact Blocks - Front Mount (1NO + 1NC) for CWB	12123053	\$57.07	\$25.11
BFB-20	Auxiliary Contact Blocks - Front Mount (2NO) for CWB	12122434	\$57.07	\$25.11
BFB-02	Auxiliary Contact Blocks - Front Mount (2NC) for CWB	12122946	\$67.92	\$29.88
BFB-22	Auxiliary Contact Blocks - Front Mount (2NO + 2NC) for CWB	12123051	\$94.66	\$41.65
BFB-31	Auxiliary Contact Blocks - Front Mount (3NO + 1NC) for CWB	12123049	\$94.66	\$41.65
BFB-13	Auxiliary Contact Blocks - Front Mount (1NO + 3NC) for CWB	12123052	\$94.66	\$41.65
BFB-40	Auxiliary Contact Blocks - Front Mount (4NO) for CWB	12122947	\$94.66	\$41.65
BFB-04	Auxiliary Contact Blocks - Front Mount (4NC) for CWB	12123048	\$94.66	\$41.65
BLB-11	Auxiliary Contact Blocks - Side Mount (1NO + 1NC) for CWB	12187899	\$88.34	\$38.87
BLB-20	Auxiliary Contact Blocks - Side Mount (2NO) for CWB	12187334	\$79.36	\$34.92
BLB-02	Auxiliary Contact Blocks - Side Mount (2NC) for CWB	12187898	\$82.97	\$36.51
BLRB-11	Auxiliary Contact Blocks - Double Stack Side Mount (1NO + 1NC) for CWB	12230321	\$88.34	\$38.87
BLRB-20	Auxiliary Contact Blocks - Double Stack Side Mount (2NO) for CWB	12230319	\$79.36	\$34.92
BLRB-02	Auxiliary Contact Blocks - Double Stack Side Mount (2NC) for CWB	12230320	\$82.97	\$36.51
EC-SD1	Busbars Star-Delta Starter for CWB9...38	12241230	\$240.37	\$105.76
EC-SD2	Busbars Star-Delta Starter for CWB40...80	13619635	\$289.14	\$127.22
SBCB9-18	Busbar Star for CWB9...38	13454331	\$45.29	\$19.93
SBCB40-80	Busbar Star for CWB40...80	13913428	\$65.49	\$28.82
EC-R1	Busbars Reversing Starter for CWB9...38	12241229	\$179.13	\$78.82
EC-R2	Busbars Reversing Starter for CWB40...80	13619637	\$226.43	\$99.63
IM1	Mechanical interlock for CWB9...38	12244300	\$28.87	\$12.70
IM2	Mechanical interlock for CWB40...80	13765620	\$32.56	\$14.33
RCBD53	Surge Suppressor Block for CWB9...38 (24...48Vac) for CWB	12242511	\$72.53	\$31.91
RCBD55	Surge Suppressor Block for CWB9...38 (50...127Vac) for CWB	12242512	\$72.53	\$31.91
RCBD63	Surge Suppressor Block for CWB9...38 (130...250Vac) for CWB	12242513	\$72.53	\$31.91
VRBD73	Surge Suppressor Block for CWB9...38 (400...510Vac) for CWB	12242558	\$72.53	\$31.91
VRBE49	Surge Suppressor Block for CWB9...38 (12...48Vac / 12...60Vdc) for CWB	12242514	\$72.53	\$31.91
VRBE34	Surge Suppressor Block for CWB9...38 (50...127Vac / 60...180Vdc) for CWB	12242515	\$72.53	\$31.91
VRBE50	Surge Suppressor Block for CWB9...38 (130...250Vac / 180...300Vdc) for CWB	12242516	\$72.53	\$31.91
VRBE41	Surge Suppressor Block for CWB9...38 (277...380Vac / 300...510Vdc) for CWB	12242517	\$72.53	\$31.91
DIBC33	Surge Suppressor Block for CWB9...38 (12...600Vdc) for CWB	12242560	\$72.53	\$31.91
DIZBC26	Surge Suppressor Block for CWB9...38 (12...250Vdc) for CWB	12242561	\$72.53	\$31.91
BRB-38D02	Coil 24Vac for CWB9...38	12243117	\$130.50	\$57.42
BRB-38D07	Coil 48Vac for CWB9...38	12657821	\$130.50	\$57.42
BRB-38D13	Coil 110Vac for CWB9...38	12243218	\$130.50	\$57.42
BRB-38D24	Coil 230Vac for CWB9...38	12679407	\$130.50	\$57.42
BRB-38D25	Coil 240Vac for CWB9...38	12679440	\$130.50	\$57.42
BRB-38D34	Coil 400Vac for CWB9...38	12657822	\$130.50	\$57.42
BRB-38D35	Coil 415Vac for CWB9...38	12679438	\$130.50	\$57.42
BRB-80D02	Coil 24Vac for CWB40...80	13909651	\$177.22	\$77.98
BRB-80D07	Coil 48Vac for CWB40...80	14349098	\$177.22	\$77.98
BRB-80D13	Coil 110Vac for CWB40...80	13909653	\$177.22	\$77.98
BRB-80D24	Coil 230Vac for CWB40...80	13909671	\$177.22	\$77.98
BRB-80D25	Coil 240Vac for CWB40...80	13909674	\$177.22	\$77.98
BRB-80D34	Coil 400Vac for CWB40...80	13909677	\$177.22	\$77.98
BRB-80D35	Coil 415Vac for CWB40...80	13909694	\$177.22	\$77.98
BRB-125E04	Coil 24-60 Vac/dc for CWB95...125	15479907	\$529.05	\$232.78
BRB-125E64	Coil 48-130Vac/dc for CWB95...125	16064743	\$529.05	\$232.78
BRB-125E65	Coil 110-255Vac/dc for CWB95...125	15233682	\$529.05	\$232.78
BRB-125E66	Coil 250-500Vac/dc for CWB95...125	16064746	\$529.05	\$232.78

Prices Exclude GST and are subject to change at any time Ref: V24



CWB Series

- CWBS Safety Contactors

WEG CWB Contactors are modular and compact but at the same time robust and highly reliable. Easy installation and energy savings meet the expectations of users who want to perform automation in a more simple and practical way. AC-3 rating

Item number	Description	SAP number	Trade Price	Contractor Price
CWBS9-11-30C03	9A 3-Pole CWB Safety Contactor 1NO + 1NC (24Vdc coil)	13522438	\$269.79	\$118.71
CWBS12-11-30C03	12A 3-Pole CWB Safety Contactor 1NO + 1NC (24Vdc coil)	13522441	\$290.25	\$127.71
CWBS18-11-30C03	18A 3-Pole CWB Safety Contactor 1NO + 1NC (24Vdc coil)	13522445	\$328.62	\$144.59
CWBS25-11-30C03	25A 3-Pole CWB Safety Contactor 1NO + 1NC (24Vdc coil)	13522490	\$393.28	\$173.04
CWBS32-11-30C03	32A 3-Pole CWB Safety Contactor 1NO + 1NC (24Vdc coil)	13522496	\$542.31	\$238.62
CWBS38-11-30C03	38A 3-Pole CWB Safety Contactor 1NO + 1NC (24Vdc coil)	13522512	\$583.00	\$256.52
CWBS40-11-30C03	40A 3-Pole CWB Safety Contactor 1NO + 1NC (24Vdc coil)	14280433	\$935.28	\$411.52
CWBS50-11-30C03	50A 3-Pole CWB Safety Contactor 1NO + 1NC (24Vdc coil)	14280451	\$1,118.00	\$491.92
CWBS65-11-30C03	65A 3-Pole CWB Safety Contactor 1NO + 1NC (24Vdc coil)	14280457	\$1,280.62	\$563.47
CWBS80-11-30C03	80A 3-Pole CWB Safety Contactor 1NO + 1NC (24Vdc coil)	14280490	\$1,408.69	\$619.82
CWBS9-33-30C03	9A 3-Pole CWB Safety Contactor 3NO + 3NC (24Vdc coil)	13793492	\$426.28	\$187.56
CWBS12-33-30C03	12A 3-Pole CWB Safety Contactor 3NO + 3NC (24Vdc coil)	13614114	\$451.79	\$198.79
CWBS18-33-30C03	18A 3-Pole CWB Safety Contactor 3NO + 3NC (24Vdc coil)	13793495	\$497.44	\$218.87
CWBS25-33-30C03	25A 3-Pole CWB Safety Contactor 3NO + 3NC (24Vdc coil)	13793496	\$528.32	\$232.46
CWBS32-33-30C03	32A 3-Pole CWB Safety Contactor 3NO + 3NC (24Vdc coil)	13793497	\$610.21	\$268.49
CWBS38-33-30C03	38A 3-Pole CWB Safety Contactor 3NO + 3NC (24Vdc coil)	13793578	\$684.73	\$301.28
CWBS40-33-30C03	40A 3-Pole CWB Safety Contactor 3NO + 3NC (24Vdc coil)	14280448	\$935.28	\$411.52
CWBS50-33-30C03	50A 3-Pole CWB Safety Contactor 3NO + 3NC (24Vdc coil)	14280454	\$1,118.00	\$491.92
CWBS65-33-30C03	65A 3-Pole CWB Safety Contactor 3NO + 3NC (24Vdc coil)	14280489	\$1,321.11	\$581.29
CWBS80-33-30C03	80A 3-Pole CWB Safety Contactor 3NO + 3NC (24Vdc coil)	14280683	\$1,671.54	\$735.48
CWBS9-33-30D02	9A 3-Pole CWB Safety Contactor 3NO + 3NC (24Vac coil)	14128705	\$361.83	\$159.21
CWBS12-33-30D02	12A 3-Pole CWB Safety Contactor 3NO + 3NC (24Vac coil)	14096259	\$386.68	\$170.14
CWBS18-33-30D02	18A 3-Pole CWB Safety Contactor 3NO + 3NC (24Vac coil)	14340785	\$428.98	\$188.75
CWBS25-33-30D02	25A 3-Pole CWB Safety Contactor 3NO + 3NC (24Vac coil)	14096234	\$461.19	\$202.92
CWBS32-33-30D02	32A 3-Pole CWB Safety Contactor 3NO + 3NC (24Vac coil)	14340786	\$543.10	\$238.96
CWBS38-33-30D02	38A 3-Pole CWB Safety Contactor 3NO + 3NC (24Vac coil)	14340787	\$618.93	\$272.33
CWBS40-33-30D02	40A 3-Pole CWB Safety Contactor 3NO + 3NC (24Vac coil)	14280349	\$935.28	\$411.52
CWBS50-33-30D02	50A 3-Pole CWB Safety Contactor 3NO + 3NC (24Vac coil)	14280357	\$1,118.00	\$491.92
CWBS65-33-30D02	65A 3-Pole CWB Safety Contactor 3NO + 3NC (24Vac coil)	14280376	\$1,280.62	\$563.47
CWBS80-33-30D02	80A 3-Pole CWB Safety Contactor 3NO + 3NC (24Vac coil)	14280416	\$1,408.69	\$619.82
CWBS95-15-30D02	95A 3-Pole CWB Safety Contactor 1NO + 5NC (24Vac coil)	TBA	\$1,600.02	\$704.01
CWBS110-15-30D02	110A 3-Pole CWB Safety Contactor 1NO + 5NC (24Vac coil)	TBA	\$1,740.92	\$766.00
CWBS9-33-30D25	9A 3-Pole CWB Safety Contactor 3NO + 3NC (240Vac coil)	14340345	\$361.83	\$159.21
CWBS12-33-30D25	12A 3-Pole CWB Safety Contactor 3NO + 3NC (240Vac coil)	14340346	\$386.68	\$170.14
CWBS18-33-30D25	18A 3-Pole CWB Safety Contactor 3NO + 3NC (240Vac coil)	14340347	\$428.96	\$188.74
CWBS25-33-30D25	25A 3-Pole CWB Safety Contactor 3NO + 3NC (240Vac coil)	14340408	\$461.18	\$202.92
CWBS32-33-30D25	32A 3-Pole CWB Safety Contactor 3NO + 3NC (240Vac coil)	14340409	\$543.07	\$238.95
CWBS38-33-30D25	38A 3-Pole CWB Safety Contactor 3NO + 3NC (240Vdc coil)	14340410	\$618.93	\$272.33
CWBS40-33-30D25	40A 3-Pole CWB Safety Contactor 3NO + 3NC (240Vac coil)	14340413	\$935.28	\$411.52
CWBS50-33-30D25	50A 3-Pole CWB Safety Contactor 3NO + 3NC (240Vac coil)	14340414	\$1,118.00	\$491.92
CWBS65-33-30D25	65A 3-Pole CWB Safety Contactor 3NO + 3NC (240Vac coil)	14340415	\$1,280.62	\$563.47
CWBS80-33-30D25	80A 3-Pole CWB Safety Contactor 3NO + 3NC (240Vac coil)	14340417	\$1,408.69	\$619.82
CWBS95-15-30D25	95A 3-Pole CWB Safety Contactor 1NO + 5NC (240Vac coil)	TBA	\$1,600.02	\$704.01
CWBS110-15-30D25	110A 3-Pole CWB Safety Contactor 1NO + 5NC (240Vac coil)	TBA	\$1,740.92	\$766.00

Contractor

Other Coil Voltages available on request

CWC CONTACTORS



Assembly Efficiency



Indication of Position or State



Mirror and Mechanically Linked Contacts



Built-In Auxiliary Contacts - 1NO or 1NC



Low-consumption, direct current coils



CWC Series

- CWC Contactors

The CWC0 mini contactors have a compact design and are offered as a complete solution for switching and controlling motors AC-3 rating

Item number	Description	SAP number	Trade Price	Contractor Price
CW07-10-30D24	7A 3 pole CW miniature contactor 240Vac coil (+1NO)	12896406	\$112.55	\$49.52
CW07-01-30D24	7A 3 pole CW miniature contactor 240Vac coil (+1NC)	13128649	\$112.55	\$49.52
CW07-10-30V47	7A 3 pole CW miniature contactor 400 - 415Vac coil (+1NO)	12679914	\$112.55	\$49.52
CW07-01-30V47	7A 3 pole CW miniature contactor 400 - 415Vac coil (+1NC)	12679915	\$112.55	\$49.52
CW07-10-30D02	7A 3 pole CW miniature contactor 24Vac coil (+1NO)	12896385	\$112.55	\$49.52
CW07-01-30D02	7A 3 pole CW miniature contactor 24Vac coil (+1NC)	12896492	\$112.55	\$49.52
CWC07-10-30D25	7A 3 pole CWC minicontactor 240Vac coil (+1NO)	12487289	\$136.53	\$60.07
CWC07-01-30D25	7A 3 pole CWC minicontactor 240Vac coil (+1NC)	12867952	\$136.53	\$60.07
CWC09-10-30D25	9A 3 pole CWC minicontactor 240Vac coil (+1NO)	12867990	\$159.78	\$70.30
CWC09-01-30D25	9A 3 pole CWC minicontactor 240Vac coil (+1NC)	12867988	\$159.78	\$70.30
CWC012-10-30D25	12A 3 pole CWC minicontactor 240Vac coil (+1NO)	12867997	\$164.48	\$72.37
CWC012-01-30D25	12A 3 pole CWC minicontactor 240Vac coil (+1NC)	12867995	\$164.48	\$72.37
CWC016-10-30D25	16A 3 pole CWC minicontactor 240Vac coil (+1NO)	12868014	\$209.43	\$92.15
CWC016-01-30D25	16A 3 pole CWC minicontactor 240Vac coil (+1NC)	12868012	\$209.43	\$92.15
CWC025-00-30D25	22A 3 pole CWC minicontactor 240Vac coil	12868017	\$261.81	\$115.20
CWC07-10-30D35	7A 3 pole CWC minicontactor 415Vac coil (+1NO)	12867954	\$136.53	\$60.07
CWC07-01-30D35	7A 3 pole CWC minicontactor 415Vac coil (+1NC)	12867953	\$136.53	\$60.07
CWC09-10-30D35	9A 3 pole CWC minicontactor 415Vac coil (+1NO)	12867991	\$159.78	\$70.30
CWC09-01-30D35	9A 3 pole CWC minicontactor 415Vac coil (+1NC)	12867989	\$159.78	\$70.30
CWC012-10-30D35	12A 3 pole CWC minicontactor 415Vac coil (+1NO)	12868008	\$164.48	\$72.37
CWC012-01-30D35	12A 3 pole CWC minicontactor 415Vac coil (+1NC)	12867996	\$164.48	\$72.37
CWC016-10-30D35	16A 3 pole CWC minicontactor 415Vac coil (+1NO)	12868016	\$209.43	\$92.15
CWC016-01-30D35	16A 3 pole CWC minicontactor 415Vac coil (+1NC)	12868013	\$209.43	\$92.15
CWC025-00-30D35	22A 3 pole CWC minicontactor 415Vac coil	12868038	\$261.81	\$115.20
CWC07-10-30D02	7A 3 pole CWC minicontactor 24Vac coil (+1NO)	12487293	\$136.53	\$60.07
CWC07-01-30D02	7A 3 pole CWC minicontactor 24Vac coil (+1NC)	12487294	\$136.53	\$60.07
CWC09-10-30D02	9A 3 pole CWC minicontactor 24Vac coil (+1NO)	12487235	\$159.78	\$70.30
CWC09-01-30D02	9A 3 pole CWC minicontactor 24Vac coil (+1NC)	12487310	\$159.78	\$70.30
CWC012-10-30D02	12A 3 pole CWC minicontactor 24Vac coil (+1NO)	12487313	\$164.48	\$72.37
CWC012-01-30D02	12A 3 pole CWC minicontactor 24Vac coil (+1NC)	12487233	\$164.48	\$72.37
CWC016-10-30D02	16A 3 pole CWC minicontactor 24Vac coil (+1NO)	12487346	\$209.43	\$92.15
CWC016-01-30D02	16A 3 pole CWC minicontactor 24Vac coil (+1NC)	12487344	\$209.43	\$92.15
CWC025-00-30D02	22A 3 pole CWC minicontactor 24Vac coil	12487309	\$261.81	\$115.20
CWC07-10-30C03	7A 3 pole CWC minicontactor 24Vdc coil (+1NO)	12486689	\$170.83	\$75.17
CWC07-01-30C03	7A 3 pole CWC minicontactor 24Vdc coil (+1NC)	12486690	\$170.83	\$75.17
CWC09-10-30C03	9A 3 pole CWC minicontactor 24Vdc coil (+1NO)	12486691	\$188.94	\$83.13
CWC09-01-30C03	9A 3 pole CWC minicontactor 24Vdc coil (+1NC)	12486692	\$188.94	\$83.13
CWC012-10-30C03	12A 3 pole CWC minicontactor 24Vdc coil (+1NO)	12486694	\$248.37	\$109.28
CWC012-01-30C03	12A 3 pole CWC minicontactor 24Vdc coil (+1NC)	12486695	\$248.37	\$109.28
CWC016-10-30C03	16A 3 pole CWC minicontactor 24Vdc coil (+1NO)	12486696	\$298.06	\$131.15
CWC016-01-30C03	16A 3 pole CWC minicontactor 24Vdc coil (+1NC)	12486697	\$298.06	\$131.15

Contractor

Prices Exclude GST and are subject to change at any time Ref: V24



CWC Series

- CWCA0 Control Relays

The CWCA0 mini contactors have a compact design and are offered as a complete solution for controlling motors AC-3 rating

Item number	Description	SAP number	Trade Price	Contractor Price
CWCA0-22-00D02	10A CWCA0 Control Relay 24Vac coil (2NO + 2NC)	12487308	\$176.21	\$77.53
CWCA0-31-00D02	10A CWCA0 Control Relay 24Vac coil (3NO + 1NC)	12487312	\$176.21	\$77.53
CWCA0-13-00D02	10A CWCA0 Control Relay 24Vac coil (1NO + 3NC)	12680317	\$176.21	\$77.53
CWCA0-40-00D02	10A CWCA0 Control Relay 24Vac coil (4NO)	12680428	\$176.21	\$77.53
CWCA0-04-00D02	10A CWCA0 Control Relay 24Vac coil (4NC)	12680429	\$176.21	\$77.53
CWCA0-22-00D24	10A CWC Control Relay 230Vac coil (2NO + 2NC)	12487358	\$176.21	\$77.53
CWCA0-31-00D24	10A CWC Control Relay 230Vac coil (3NO + 1NC)	12680433	\$176.21	\$77.53
CWCA0-22-00D25	10A CWCA0 Control Relay 240Vac coil (2NO + 2NC)	13846584	\$176.21	\$77.53
CWCA0-31-00D25	10A CWCA0 Control Relay 240Vac coil (3NO + 1NC)	13717865	\$176.21	\$77.53
CWCA0-13-00D25	10A CWCA0 Control Relay 240Vac coil (1NO + 3NC)	13780141	\$176.21	\$77.53
CWCA0-40-00D25	10A CWCA0 Control Relay 240Vac coil (4NO)	13717866	\$176.21	\$77.53
CWCA0-04-00D25	10A CWCA0 Control Relay 240Vac coil (4NC)	14147810	\$176.21	\$77.53
CWCA0-22-00D35	10A CWCA0 Control Relay 415Vac coil (2NO + 2NC)	14147811	\$176.21	\$77.53
CWCA0-31-00D35	10A CWCA0 Control Relay 415Vac coil (3NO + 1NC)	14147813	\$176.21	\$77.53
CWCA0-13-00D35	10A CWCA0 Control Relay 415Vac coil (1NO + 3NC)	14147814	\$176.21	\$77.53
CWCA0-40-00D35	10A CWCA0 Control Relay 415Vac coil (4NO)	14147815	\$176.21	\$77.53
CWCA0-04-00D35	10A CWCA0 Control Relay 415Vac coil (4NC)	14147816	\$176.21	\$77.53
CWCA0-22-00C03	10A CWCA0 Control Relay 24Vdc coil (2NO + 2NC)	12486869	\$189.64	\$83.44
CWCA0-31-00C03	10A CWCA0 Control Relay 24Vdc coil (3NO + 1NC)	12486870	\$189.64	\$83.44
CWCA0-13-00C03	10A CWCA0 Control Relay 24Vdc coil (1NO + 3NC)	12486871	\$189.64	\$83.44
CWCA0-40-00C03	10A CWCA0 Control Relay 24Vdc coil (4NO)	12486872	\$189.64	\$83.44
CWCA0-04-00C03	10A CWCA0 Control Relay 24Vdc coil (4NC)	12486873	\$189.64	\$83.44
CWCA0-22-00L03	10A CWCA0 Control Relay 24Vdc low consumption coil (2NO + 2NC) *	12486879	\$192.66	\$84.77
CWCA0-31-00L03	10A CWCA0 Control Relay 24Vdc low consumption coil (3NO + 1NC) *	12486880	\$192.66	\$84.77
CWCA0-13-00L03	10A CWCA0 Control Relay 24Vdc low consumption coil (1NO + 3NC) *	12486881	\$192.66	\$84.77
CWCA0-40-00L03	10A CWCA0 Control Relay 24Vdc low consumption coil (4NO) *	12486882	\$192.66	\$84.77
CWCA0-04-00L03	10A CWCA0 Control Relay 24Vdc low consumption coil (4NC) *	12486883	\$192.66	\$84.77

Contractor

* Low Consumption coil - auxiliary block front mounting available at a maximum of 2 contacts.



CWC Series

- CWC Contactors Accessories

The CWC0 mini contactors have a compact design and are offered as a complete solution for switching and controlling motors

Item number	Description	SAP number	Trade Price	Contractor Price
BFC0-20	Aux Contact Block Front Mount (2NO) for CWC0 2/3P	12499352	\$64.80	\$40.18
BFC0-11	Aux Contact Block Front Mount (1NO + 1NC) for CWC0 2/3P	12499350	\$64.80	\$40.18
BFC0-02	Aux Contact Block Front Mount (2NC) for CWC0 2/3P	12499348	\$64.80	\$40.18
BFC0-40	Aux Contact Block Front Mount (4NO) for CWC0 2/3P	12499359	\$102.56	\$63.59
BFC0-22	Aux Contact Block Front Mount (2NO + 2NC) for CWC0 2/3P	12499353	\$102.56	\$63.59
BFC0-04	Aux Contact Block Front Mount (4NC) for CWC0 2/3P	12499349	\$102.56	\$63.59
BFC0-31	Aux Contact Block Front Mount (3NO + 1NC) for CWC0 2/3P	12499358	\$102.56	\$63.59
BFC0-13	Aux Contact Block Front Mount (1NO + 3NC) for CWC0 2/3P	12499351	\$102.56	\$63.59
BFC025-20	Aux Contact Block Front Mount (2NO) for CWC025 2/3P	12499356	\$64.80	\$40.18
BFC025-11	Aux Contact Block Front Mount (1NO + 1NC) for CWC025 2/3P	12499355	\$64.80	\$40.18
BFC025-02	Aux Contact Block Front Mount (2NC) for CWC025 2/3P	12499354	\$64.80	\$40.18
BFC025-22	Aux Contact Block Front Mount (2NO + 2 NC) for CWC025 2/3P	12499357	\$102.56	\$63.59
BFCA-20	Aux Contact Block Front Mount (2NO) for CWCA0	12499382	\$64.80	\$40.18
BFCA-11	Aux Contact Block Front Mount (1NO + 1NC) for CWCA0	12499380	\$64.80	\$40.18
BFCA-02	Aux Contact Block Front Mount (2NC) for CWCA0	12499378	\$64.80	\$40.18
BFCA-40	Aux Contact Block Front Mount (4NO) for CWCA0	12499385	\$102.56	\$63.59
BFCA-22	Aux Contact Block Front Mount (2NO + 2NC) for CWCA0	12499383	\$102.56	\$63.59
BFCA-04	Aux Contact Block Front Mount (4NC) for CWCA0	12499379	\$102.56	\$63.59
BFCA-31	Aux Contact Block Front Mount (3NO + 1NC) for CWCA0	12499384	\$102.56	\$63.59
BFCA-13	Aux Contact Block Front Mount (1NO + 3NC) for CWCA0	12499381	\$102.56	\$63.59
RCC0-4D63	Surge suppressor block for CWC0 contactor 127-250 Vac	12500586	\$61.32	\$38.02
VRC0-1E49	Surge suppressor block for CWC0 contactor 12-48 V ac / 12-60 V dc	12500630	\$61.32	\$38.02
RMC0	Latch block for CWC0	12499467	\$68.46	\$42.45
BIC0	Mechanical interlock block for CWC07 - CWC016	12499466	\$46.99	\$29.13
TECO-U003S-E05	ON Delay Electronic Timer block 24-240 Vac/dc (0.3s...3s) for CWC07 - CWC025	12499386	\$471.63	\$292.41
TECO-U010S-E05	ON Delay Electronic Timer block 24-240 Vac/dc (1s...10s) for CWC07 - CWC025	12499398	\$471.63	\$292.41
TECO-U030S-E05	ON Delay Electronic Timer block 24-240 Vac/dc (3s...30s) for CWC07 - CWC025	12499445	\$471.63	\$292.41
TECO-U060S-E05	ON Delay Electronic Timer block 24-240 Vac/dc (6s...60s) for CWC07 - CWC025	12499447	\$471.63	\$292.41
TECO-U100S-E05	ON Delay Electronic Timer block 24-240 Vac/dc (10s...100s) for CWC07 - CWC025	12499399	\$471.63	\$292.41
TECO-U300S-E05	ON Delay Electronic Timer block 24-240 Vac/dc (30s...300s) for CWC07 - CWC025	12499400	\$471.63	\$292.41
TECO-U030M-E05	ON Delay Electronic Timer block 24-240 Vac/dc (3min...30min) for CWC07 - CWC025	12499461	\$471.63	\$292.41
TDC0-U003S-E04	OFF Delay Electronic Timer block 24-60 Vac/dc (0.3s...3s) for CWC07 - CWC025	12499401	\$610.27	\$378.37
TDC0-U010S-E04	OFF Delay Electronic Timer block 24-60 Vac/dc (1s...10s) for CWC07 - CWC025	12499402	\$610.27	\$378.37
TDC0-U030S-E04	OFF Delay Electronic Timer block 24-60 Vac/dc (3s...30s) for CWC07 - CWC025	12499403	\$610.27	\$378.37
TDC0-U060S-E04	OFF Delay Electronic Timer block 24-60 Vac/dc (6s...60s) for CWC07 - CWC025	12499407	\$610.27	\$378.37
TDC0-U100S-E04	OFF Delay Electronic Timer block 24-60 Vac/dc (10s...100s) for CWC07 - CWC025	12499404	\$610.27	\$378.37
TDC0-U300S-E04	OFF Delay Electronic Timer block 24-60 Vac/dc (30s...300s) for CWC07 - CWC025	12499405	\$610.27	\$378.37
TDC0-U030M-E04	OFF Delay Electronic Timer block 24-60 Vac/dc (3min...30min) for CWC07 - CWC025	12499438	\$610.27	\$378.37
TDC0-U003S-E09	OFF Delay Electronic Timer block 100-240 Vac/dc (0.3s...3s) for CWC07 - CWC025	12499462	\$610.27	\$378.37
TDC0-U010S-E09	OFF Delay Electronic Timer block 100-240 Vac/dc (1s...10s) for CWC07 - CWC025	12499439	\$610.27	\$378.37
TDC0-U030S-E09	OFF Delay Electronic Timer block 100-240 Vac/dc (3s...30s) for CWC07 - CWC025	12499463	\$610.27	\$378.37
TDC0-U060S-E09	OFF Delay Electronic Timer block 100-240 Vac/dc (6s...60s) for CWC07 - CWC025	12499440	\$610.27	\$378.37
TDC0-U100S-E09	OFF Delay Electronic Timer block 100-240 Vac/dc (10s...100s) for CWC07 - CWC025	12499441	\$610.27	\$378.37
TDC0-U300S-E09	OFF Delay Electronic Timer block 100-240 Vac/dc (30s...300s) for CWC07 - CWC025	12499442	\$610.27	\$378.37
TDC0-U030M-E09	OFF Delay Electronic Timer block 100-240 Vac/dc (3min...30min) for CWC07 - CWC025	12499464	\$610.27	\$378.37
TETCO-U030S-D52	Star-Delta delay Electronic timing block 24-28Vac/dc (3s...30s) for CWC07- 025	12499443	\$487.99	\$302.55
TETCO-U030S-D66	Star-Delta delay Electronic timing block 220-240Vac/dc (3s...30s) for CWC07- 025	12499387	\$487.99	\$302.55
ECC0-R	Bus bar Reversing starter for CWC0	10047150	\$90.43	\$56.07
ECC0-SD	Bus bar Star-delta starter for CWC0	10047151	\$100.71	\$62.44
ECCMP-C0	Link module for Contactor CWC07...16-MPW40	10047217	\$44.91	\$27.84
ECCMP-C025	Link module for Contactor CWC025-MPW40	10689937	\$44.91	\$27.84

Prices Exclude GST and are subject to change at any time Ref: V24

CWM CONTACTORS



Easy installation and maintenance



Spare parts and accessories available for the entire line



Two possibilities for auxiliary contacts: fixed or additional blocks



Electronic module that enables the use of AC or DC currents



Technical specifications according to standards: IEC 60947-1, IEC 60947-4-1, VDE 0660/102, UL-508, CSA C.22.2/14 and CENELEC HD 419.















































CWM Series

- CWM Contactors (9A - 105A)

The CWM general-purpose contactor line has been designed taking into consideration industrial duty and reliability.

AC-3 Rating

Item number	Description	SAP number	Trade Price	Contractor Price
 CWM9-11-30D25	9A 3 pole CWM contactor 240Vac coil (1NO + 1NC)	10074188	\$184.61	\$81.23
 CWM12-11-30D25	12A 3 pole CWM contactor 240Vac coil (1NO + 1NC)	10452635	\$196.02	\$86.25
 CWM18-11-30D25	18A 3 pole CWM contactor 240Vac coil (1NO + 1NC)	* 10074190	\$271.20	\$119.33
 CWM25-11-30D25	25A 3 pole CWM contactor 240Vac coil (1NO + 1NC)	10074193	\$362.50	\$159.50
 CWM32-11-30D25	32A 3 pole CWM contactor 240Vac coil (1NO + 1NC)	10074197	\$441.72	\$194.36
 CWM40-11-30D25	40A 3 pole CWM contactor 240Vac coil (1NO + 1NC)	10074199	\$527.65	\$232.17
 CWM50-11-30D25	50A 3 pole CWM contactor 240Vac coil (1NO + 1NC)	10074217	\$868.65	\$382.21
 CWM65-11-30D25	65A 3 pole CWM contactor 240Vac coil (1NO + 1NC)	10074220	\$910.28	\$400.52
 CWM80-11-30D25	80A 3 pole CWM contactor 240Vac coil (1NO + 1NC)	* 10074223	\$1,247.27	\$548.80
 CWM95-11-30D25	95A 3 pole CWM contactor 240Vac coil (1NO + 1NC)	10074226	\$1,374.83	\$604.93
 CWM105-11-30D25	105A 3 pole CWM contactor 240Vac coil (1NO + 1NC)	10074229	\$1,476.86	\$649.82
 CWM9-11-30D35	9A 3 pole CWM contactor 415Vac coil (1NO + 1NC)	10074201	\$184.61	\$81.23
 CWM12-11-30D35	12A 3 pole CWM contactor 415Vac coil (1NO + 1NC)	10074203	\$196.02	\$86.25
 CWM18-11-30D35	18A 3 pole CWM contactor 415Vac coil (1NO + 1NC)	* 10074205	\$271.20	\$119.33
 CWM25-11-30D35	25A 3 pole CWM contactor 415Vac coil (1NO + 1NC)	10074209	\$362.50	\$159.50
 CWM32-11-30D35	32A 3 pole CWM contactor 415Vac coil (1NO + 1NC)	10074213	\$441.72	\$194.36
 CWM40-11-30D35	40A 3 pole CWM contactor 415Vac coil (1NO + 1NC)	10074215	\$527.65	\$232.17
 CWM50-11-30D35	50A 3 pole CWM contactor 415Vac coil (1NO + 1NC)	10074234	\$868.65	\$382.21
 CWM65-11-30D35	65A 3 pole CWM contactor 415Vac coil (1NO + 1NC)	10651737	\$910.28	\$400.52
 CWM80-11-30D35	80A 3 pole CWM contactor 415Vac coil (1NO + 1NC)	* 10074242	\$1,247.27	\$548.80
 CWM95-11-30D35	95A 3 pole CWM contactor 415Vac coil (1NO + 1NC)	10074247	\$1,374.83	\$604.93
 CWM105-11-30D35	105A 3 pole CWM contactor 415Vac coil (1NO + 1NC)	10074253	\$1,476.86	\$649.82
 CWM9-11-30D02	9A 3 pole CWM contactor 24Vac coil (1NO + 1NC)	10648078	\$184.61	\$81.23
 CWM12-11-30D02	12A 3 pole CWM contactor 24Vac coil (1NO + 1NC)	10046218	\$196.02	\$86.25
 CWM18-11-30D02	18A 3 pole CWM contactor 24Vac coil (1NO + 1NC)	* 10073302	\$271.20	\$119.33
 CWM25-11-30D02	25A 3 pole CWM contactor 24Vac coil (1NO + 1NC)	10071289	\$362.50	\$159.50
 CWM32-11-30D02	32A 3 pole CWM contactor 24Vac coil (1NO + 1NC)	10071647	\$441.72	\$194.36
 CWM40-11-30D02	40A 3 pole CWM contactor 24Vac coil (1NO + 1NC)	10045507	\$527.65	\$232.17
 CWM50-11-30D02	50A 3 pole CWM contactor 24Vac coil (1NO + 1NC)	10045517	\$868.65	\$382.21
 CWM65-11-30D02	65A 3 pole CWM contactor 24Vac coil (1NO + 1NC)	10045526	\$910.28	\$400.52
 CWM80-11-30D02	80A 3 pole CWM contactor 24Vac coil (1NO + 1NC)	* 10071427	\$1,247.27	\$548.80
 CWM95-11-30D02	95A 3 pole CWM contactor 24Vac coil (1NO + 1NC)	10071429	\$1,374.83	\$604.93
 CWM105-11-30D02	105A 3 pole CWM contactor 24Vac coil (1NO + 1NC)	10071288	\$1,476.86	\$649.82
 CWM9-11-30C03	9A 3 pole CWM contactor 24Vdc coil (1NO)	10535681	\$382.65	\$168.37
 CWM12-10-30C03	12A 3 pole CWM contactor 24Vdc coil (1NO)	10535683	\$406.82	\$179.00
 CWM18-10-30C03	18A 3 pole CWM contactor 24Vdc coil (1NO)	* 10535685	\$501.37	\$220.60
 CWM25-10-30C03	25A 3 pole CWM contactor 24Vdc coil (1NO)	10535688	\$592.48	\$260.69
 CWM32-10-30C34	32A 3 pole CWM contactor 24Vdc coil (1NO)	10535691	\$847.78	\$373.02
 CWM40-11-30C34	40A 3 pole CWM contactor 24Vdc coil (1NO + 1NC)	10535694	\$937.76	\$412.61
 CWM50-11-30C34	50A 3 pole CWM contactor 24Vdc coil (1NO + 1NC)	10261727	\$2,444.40	\$1,075.54
 CWM65-11-30C34	65A 3 pole CWM contactor 24Vdc coil (1NO + 1NC)	* 10261728	\$2,666.97	\$1,173.47
 CWM80-11-30C34	80A 3 pole CWM contactor 24Vdc coil (1NO + 1NC)	10535698	\$2,734.54	\$1,203.20
 CWM95-11-30C34	95A 3 pole CWM contactor 24Vdc coil (1NO + 1NC)	10535699	\$2,801.98	\$1,232.87
 CWM105-11-30C34	105A 3 pole CWM contactor 24Vdc coil (1NO + 1NC)	10535701	\$2,836.82	\$1,248.20

Contractor

* Are being replaced by CWB contactor line



CWM Series

- CWM Contactors (112A - 1260A)

The CWM general-purpose contactor line has been designed taking into consideration industrial duty and reliability.

AC-3 Rating

Item number	Description	SAP number	Trade Price	Contractor Price
CWM112-22-30E02*	112A 3 pole CWM contactor Electr. Module AC/DC 24-28V (2NO + 2NC)	10535725	\$2,723.06	\$1,198.15
CWM150-22-30E02	150A 3 pole CWM contactor Electr. Module AC/DC 24-28V (2NO + 2NC)	10535726	\$2,807.30	\$1,235.21
CWM180-22-30E02	180A 3 pole CWM contactor Electr. Module AC/DC 24-28V (2NO + 2NC)	10535727	\$4,145.58	\$1,824.06
CWM250-22-30E02	250A 3 pole CWM contactor Electr. Module AC/DC 24-28V (2NO + 2NC)	10535728	\$5,927.38	\$2,608.05
CWM300-22-30E02	300A 3 pole CWM contactor Electr. Module AC/DC 24-28V (2NO + 2NC)	10535729	\$6,685.08	\$2,941.44
CWM112-22-30E13*	112A 3 pole CWM contactor Electr. Module AC/DC 208-250V (2NO + 2NC)	10535745	\$2,723.06	\$1,198.15
CWM150-22-30E13	150A 3 pole CWM contactor Electr. Module AC/DC 208-250V (2NO + 2NC)	10535746	\$2,807.30	\$1,235.21
CWM180-22-30E13	180A 3 pole CWM contactor Electr. Module AC/DC 208-250V (2NO + 2NC)	10535747	\$4,145.58	\$1,824.06
CWM250-22-30E13	250A 3 pole CWM contactor Electr. Module AC/DC 208-250V (2NO + 2NC)	10535748	\$5,927.38	\$2,608.05
CWM300-22-30E13	300A 3 pole CWM contactor Electr. Module AC/DC 208-250V (2NO + 2NC)	10535749	\$6,685.08	\$2,941.44
CWME400-22-30E36	400A 3 pole CWM contactor Electr. Module AC 100-240V / DC 100-220V (2NO + 2NC)	11747363	\$10,526.87	\$4,631.82
CWM500-22-30E39	500A 3 pole CWM contactor Electr. Module AC 100-240V / DC 100-220V (2NO + 2NC)	11747433	\$12,016.36	\$5,287.20
CWM630-22-30E39	630A 3 pole CWM contactor Electr. Module AC 100-240V / DC 100-220V (2NO + 2NC)	11747434	\$15,815.15	\$6,958.67
CWM800-22-30E39	800A 3 pole CWM contactor Electr. Module AC 100-240V / DC 100-220V (2NO + 2NC)	11747436	\$23,147.48	\$10,184.89
CWM1260-22-30E36	1260A 3-Pole CWM Contactor (100-240Vac 100-220Vdc coil) (1NO + 1NC)	16015887	POA	POA
CWM112-22-30E16*	112A 3 pole CWM contactor Electr. Module AC/DC 360-415V (2NO + 2NC)	10535750	\$2,723.06	\$1,198.15
CWM150-22-30E16	150A 3 pole CWM contactor Electr. Module AC/DC 360-415V (2NO + 2NC)	10535751	\$2,807.30	\$1,235.21
CWM180-22-30E16	180A 3 pole CWM contactor Electr. Module AC/DC 360-415V (2NO + 2NC)	10535752	\$4,145.58	\$1,824.06
CWM250-22-30E16	250A 3 pole CWM contactor Electr. Module AC/DC 360-415V (2NO + 2NC)	10535753	\$5,927.38	\$2,608.05
CWM300-22-30E16	300A 3 pole CWM contactor Electr. Module AC/DC 360-415V (2NO + 2NC)	10535754	\$6,685.08	\$2,941.44
CWME400-22-30D81	400A 3 pole CWM contactor Electr. Module AC 380-450 V (2NO + 2NC)	11747367	\$10,526.87	\$4,631.82
CWM500-22-30D81	500A 3 pole CWM contactor Electr. Module AC 380-450 V (2NO + 2NC)	11860885	\$12,016.36	\$5,287.20
CWM630-22-30D81	630A 3 pole CWM contactor Electr. Module AC 380-450 V (2NO + 2NC)	11860886	\$15,815.15	\$6,958.67
CWM800-22-30D81	800A 3 pole CWM contactor Electr. Module AC 380-450 V (2NO + 2NC)	11860928	\$23,147.48	\$10,184.89

* Replaced by CWB contactor line



CWM Series

- CWM Contactors - 4 Pole

The CWM general-purpose contactor line has been designed taking into consideration industrial duty and reliability.

AC-1 Rating

	Item number	Description	SAP number	Trade Price	Contractor Price
	CWM9-00-40D24	25A 4 pole CWM contactor 230Vac coil	10073258	\$220.19	\$96.88
	CWM12-00-40D24	25A 4 pole CWM contactor 230Vac coil	10072159	\$243.01	\$106.92
	CWM18-00-40D24	32A 4 pole CWM contactor 230Vac coil	10046300	\$320.88	\$141.19
	CWM18-00-40D02	32A 4 pole CWM contactor 24Vac coil	10076290	\$320.88	\$141.19
	CWM400-22-40E36	400A 4 pole CWM contactor 100-240Vac/100-220Vdc coil	11931204	\$14,000.74	\$6,160.33
	CWM500-22-40E39	500A 4 pole CWM contactor 200-240Vac/200-220Vdc coil	11931207	\$18,193.61	\$8,005.19
	CWM630-22-40E39	630A 4 pole CWM contactor 200-240Vac/200-220Vdc coil	11931259	\$21,034.17	\$9,255.03
	CWM800-22-40E39	800A 4 pole CWM contactor 200-240Vac/200-220Vdc coil	11931261	\$30,093.36	\$13,241.08
	Contractor				



CWM Series

- CWM Contactors Accessories (1)

Item number	Description	SAP number	Trade Price	Contractor Price
BCXMF10	Aux Contact Block Front Mount (1NO) for CWM9 - 105	10356473	\$31.81	\$14.00
BCXMF01	Aux Contact Block Front Mount (1NC) for CWM9 - 105	10356494	\$31.81	\$14.00
BCXML20	Aux Contact Block Side Mount (2NO) for CWM9 - 300	10045714	\$79.36	\$34.92
BCXML11	Aux Contact Block Side Mount (1NO + 1NC) for CWM9 - 300	10459053	\$88.34	\$38.87
BCXMRL20	Aux Contact Block Side Mount Double Stack (2NO) for CWM9 - 300	10186060	\$79.34	\$34.91
BCXMRL11	Aux Contact Block Side Mount Double Stack (1NO + 1NC) for CWM9 - 300	10045715	\$88.34	\$38.87
BCXML11CWM800	Aux Contact Block Side Mount (1NO + 1NC) for CWM - 800	10186852	\$298.06	\$131.15
BCXMRL11CWM800	Aux Contact Block Side Mount Double Stack (1NO + 1NC) for CWM - 800	10766850	\$298.06	\$131.15
BAMRC6D63	Surge suppressor 130-250 V ac for CWM9 - 40	10409766	\$72.53	\$31.91
BAMRC9D63	Surge suppressor 130-250 V ac for CWM50 - 105	10409767	\$72.53	\$31.91
BAMRC14D56	Surge suppressor 130-250 V ac for CWM112 - 250	10046243	\$72.53	\$31.91
TB150	IP 20 Terminal Cover for CWM112/150	12374182	\$406.97	\$179.07
TB180	IP 20 Terminal Cover for CWM180	12374183	\$416.44	\$183.23
TB300	IP 20 Terminal Cover for CWM250/300	12374184	\$535.37	\$235.56
BMPCWM150	Terminal cover for CWM112 - 150	11762172	\$376.23	\$165.54
BMPCWM180	Terminal cover for CWM180	11762174	\$376.23	\$165.54
BMPCWM300	Terminal cover for CWM250 - 300	11762177	\$376.23	\$165.54
BMPCWM400	Terminal cover for CWM400	10047280	\$294.02	\$129.37
BMPCWM800	Terminal cover for CWM 500 - 800	10047281	\$453.22	\$199.42
EC-SD-15	Bus bar Star-delta starter 11kW for (k1=k2) CWM18 and (k3) CWM9 Bus bar Star-delta starter 15kW for (k1=k2) CWM18 and (k3) CWM12	10045347	\$191.99	\$84.48
EC-SD-22	Bus bar Star-delta starter 18.5kW for (k1=k2) CWM25 and (k3) CWM18 Bus bar Star-delta starter 22kW for (k1=k2) CWM25 and (k3) CWM18	10045323	\$249.73	\$109.88
EC-SD-25	Bus bar Star-delta starter 22kW for (k1=k2) CWM32 and (k3) CWM18	10074592	\$260.46	\$114.60
EC-SD-30	Bus bar Star-delta starter 30kW for (k1=k2) CWM40 and (k3) CWM25	10045324	\$315.51	\$138.82
EC-SD-37	Bus bar Star-delta starter 37kW for (k1=k2) CWM50 and (k3) CWM25	10045325	\$349.08	\$153.60
EC-SD-55	Bus bar Star-delta starter 45kW for (k1=k2) CWM50 and (k3) CWM32 Bus bar Star-delta starter 55kW for (k1=k2) CWM65 and (k3) CWM40	10185928	\$354.44	\$155.95
EC-SD-75	Bus bar Star-delta starter 75kW for (k1=k2) CWM80 and (k3) CWM50	11134959	\$385.33	\$169.55
EC-SD-90	Bus bar Star-delta starter 75kW for (k1=k2) CWM95 and (k3) CWM50 Bus bar Star-delta starter 90kW for (k1=k2) CWM105 and (k3) CWM65	10045326	\$385.33	\$169.55
EC-R-7.5	Bus bar Reversing starter 3.7kW with BLIM 9-105 for (k1=k2) CWM9 Bus bar Reversing starter 5.5kW with BLIM 9-105 for (k1=k2) CWM12 Bus bar Reversing starter 7.5kW with BLIM 9-105 for (k1=k2) CWM18	10071342	\$123.53	\$54.35
EC-R-11	Bus bar Reversing starter 11kW with BLIM 9-105 for (k1=k2) CWM25	10185926	\$179.13	\$78.82
EC-R-18.5	Bus bar Reversing starter 15kW with BLIM 9-105 for (k1=k2) CWM32 Bus bar Reversing starter 18.5kW with BLIM 9-105 for (k1=k2) CWM40	10071340	\$212.99	\$93.72
EC-R-37	Bus bar Reversing starter 22kW with BLIM 9-105 for (k1=k2) CWM50 Bus bar Reversing starter 30kW with BLIM 9-105 for (k1=k2) CWM65 Bus bar Reversing starter 45kW with BLIM 9-105 for (k1=k2) CWM80	10185927	\$267.27	\$117.60
BLIM9-105	Mechanical interlock block for CWM9 - CWM105	10410084	\$83.24	\$36.63
BLIM.02CWM9-105	Mechanical & Electrical interlock ⁽¹⁾ block for CWM9 - CWM105	10046839	\$99.42	\$43.74
BLIM112-300	Mechanical interlock block for CWM112 - CWM300	10045676	\$263.15	\$115.79
BLIMCWM400	Mechanical interlock block for CWM400 3P/4P	10186853	\$275.23	\$121.10
BLIMCWM800	Mechanical interlock block for CWM500 - 800 3P	10047279	\$7,559.15	\$3,326.03

(1) Allows mechanical and electrical interlock through the 2 built-in NC contacts.



CWM Series
- CWM Contactors Replacements

Item number	Description	SAP number	Trade Price	Contractor Price
BCA4-25D02	Coil 24Vac for CWM 9 - 25	10045705	\$130.50	\$57.42
BCA4-40D02	Coil 24Vac for CWM 32 - 40	10047474	\$171.85	\$75.61
BCA4-105D02	Coil 24Vac for CWM 50 - 105	10045696	\$214.81	\$94.52
BCA4-112D02	Coil 24Vac for CWM 112	10656888	\$314.17	\$138.23
BCA4-180D02	Coil 24Vac for CWM 180	10046202	\$341.01	\$150.04
BCA4-250D02	Coil 24Vac for CWM 250	10072870	\$400.09	\$176.04
BCA-105D13	Coil 110-130Vac for CWM 50-105	10045692	\$214.81	\$94.52
BCA4-25D13	Coil 110-130Vac for CWM 9-25	10045707	\$171.85	\$75.61
BCA4-40D13	Coil 110-130Vac for CWM 32-40	10047475	\$214.81	\$94.52
BCE-150E10	Coil 110-130Vac/dc for CWM 112/150. Needs Electronic Module ME-300E10	10071579	\$314.17	\$138.23
BCE-215E10	Coil 110-130Vac/dc for CWM 180. Needs Electronic Module ME-300E10	10071581	\$341.01	\$150.04
BCE-300E10	Coil 110-130Vac/dc for CWM 250/300. Needs Electronic Module ME-300E10	10071583	\$400.09	\$176.04
BCA4-25D25	Coil 240Vac for CWM 9 - 25	10046598	\$130.50	\$57.42
BCA4-40D25	Coil 240Vac for CWM 32 - 40	10656651	\$171.85	\$75.61
BCA4-105D25	Coil 240Vac for CWM 50 - 105	10074245	\$214.81	\$94.52
BCA4-112D25	Coil 240Vac for CWM 112	10074248	\$314.17	\$138.23
BCA4-180D25	Coil 240Vac for CWM 180	10074252	\$341.01	\$150.04
BCA4-250D25	Coil 240Vac for CWM 250	10074256	\$400.09	\$176.04
BCE-800E39	Coil 200-240Vac/220dc for CWM 500 / 630 / 800	11746777	\$3,217.44	\$1,415.67
BCE-1260E36	Coil 100-240Vac/100-220VDC for CWM1260	16013901	\$3,828.75	\$1,684.65
BCA4-25D35	Coil 415Vac for CWM 9 - 25	10074239	\$130.50	\$57.42
BCA4-40D35	Coil 415Vac for CWM 32 - 40	10656655	\$171.85	\$75.61
BCA4-105D35	Coil 415Vac for CWM 50 - 105	10074246	\$214.81	\$94.52
BCA4-112D35	Coil 415Vac for CWM 112	10074250	\$314.17	\$138.23
BCA4-180D35	Coil 415Vac for CWM 180	10074254	\$341.01	\$150.04
BCA4-250D35	Coil 415Vac for CWM 250	10074257	\$400.09	\$176.04
BCE-400D81	Coil 380-450Vac for CWM 400	11746772	\$2,632.06	\$1,158.11
BCE-800D81	Coil 380-450Vac for CWM 500 / 630 / 800	11746779	\$3,217.44	\$1,415.67
BCC-25C03	Coil 24Vdc for CWM 9 - 25	10045694	\$179.85	\$79.13
BECC4-40C03	Coil 24Vdc for CWM 32 / CWM 40	10213264	\$378.28	\$166.44
BECC-105C03	Coil 24Vdc for CWM 50 - CWM 105	10685182	\$425.83	\$187.37
ME-300E10	Electronic Module 110V-130V 50/60Hz ac/dc for CWM112/CWM150/CWM180/CWM250/CWM300	10046223	\$842.80	\$370.83
ME-300E13	Electronic Module 208V-250V 50/60Hz ac/dc for CWM112/CWM150/CWM180/CWM250/CWM300	10046264	\$842.80	\$370.83
JCCWM9-3P	Spare Contact Set for CWM 9	10410069	\$74.36	\$32.72
JCCWM12-3P	Spare Contact Set for CWM 12	10410070	\$78.83	\$34.69
JCCWM18-3P	Spare Contact Set for CWM 18	10410071	\$84.06	\$36.99
JCCWM25-3P	Spare Contact Set for CWM 25	10410072	\$187.42	\$82.46
JCCWM32-3P	Spare Contact Set for CWM 32	10410073	\$228.89	\$100.71
JCCWM40-3P	Spare Contact Set for CWM 40	10410074	\$256.77	\$112.98
JCCWM50-3P	Spare Contact Set for CWM 50	10410075	\$509.10	\$224.00
JCCWM65-3P	Spare Contact Set for CWM 65	10410076	\$546.08	\$240.28
JCCWM80-3P	Spare Contact Set for CWM 80	10410077	\$573.47	\$252.33
JCCWM95-3P	Spare Contact Set for CWM 95	10410078	\$804.75	\$354.09
JCCWM105-3P	Spare Contact Set for CWM 105	10410079	\$936.25	\$411.95
JCCWM112-3P	Spare Contact Set for CWM 112	10410050	\$1,420.67	\$625.09
JCCWM150E-3P	Spare Contact Set for CWM 150	10186245	\$1,556.74	\$684.97
JCCWM180-3P	Spare Contact Set for CWM 180	10410051	\$1,946.47	\$856.45
JCCWM250-3P	Spare Contact Set for CWM 250	10186043	\$2,861.48	\$1,259.05
JCCWM300-3P	Spare Contact Set for CWM 300	10187066	\$3,920.39	\$1,724.97
JCCWM400-3P	Spare Contact Set for CWM 400	10213097	\$3,920.39	\$1,724.97
JCCWM500-3P	Spare Contact Set for CWM 500	11931132	\$5,652.33	\$2,487.03
JCCWM630-3P	Spare Contact Set for CWM 630	10213098	\$6,672.71	\$2,935.99
JCCWM800-3P	Spare Contact Set for CWM 800	10213099	\$6,605.57	\$2,906.45

Prices Exclude GST and are subject to change at any time Ref: V24

RW OVERLOAD RELAYS



Ambient Air Temperature Compensation



Site Altitude Compensation



Phase Failure Sensitivity



Characteristic Tripping Curve



Thermal Memory Recovery Time



Operation in the Output Side of Frequency Inverters



CWC Series

- RW17 Overload Relays

	Item number	Description	SAP number	Trade Price	Contractor Price	
	RW17-1D3-D004	Overload relay 0.28...0.4 for CWC07...16	12450892	\$196.69	\$86.54	
	RW17-1D3-C063	Overload relay 0.4...0.63 for CWC07...16	12450895	\$196.69	\$86.54	
	RW17-1D3-D008	Overload relay 0.56...0.8 for CWC07...16	12450896	\$196.69	\$86.54	
	RW17-1D3-D012	Overload relay 0.8...1.2 for CWC07...16	12450897	\$196.69	\$86.54	
	RW17-1D3-D018	Overload relay 1.2...1.8 for CWC07...16	12450898	\$196.69	\$86.54	
	RW17-1D3-D028	Overload relay 1.8...2.8 for CWC07...16	12450899	\$196.69	\$86.54	
	RW17-1D3-U004	Overload relay 2.8...4 for CWC07...16	12450900	\$196.69	\$86.54	
	RW17-1D3-D063	Overload relay 4...6.3 for CWC07...16	12450901	\$196.69	\$86.54	
	RW17-1D3-U008	Overload relay 5.6...8 for CWC07...16	12450903	\$196.69	\$86.54	
	RW17-1D3-U010	Overload relay 7...10 for CWC07...16	12450905	\$196.69	\$86.54	
	RW17-1D3-D125	Overload relay 8...12.5 for CWC07...16	12450906	\$196.69	\$86.54	
	RW17-1D3-U015	Overload relay 10...15 for CWC07...16	12450907	\$196.69	\$86.54	
	RW17-1D3-U017	Overload relay 11...17 for CWC07...16	12450908	\$196.69	\$86.54	
	RW17-2D3-U010	Overload relay 7...10 for CWC025	12450909	\$196.69	\$86.54	
	RW17-2D3-D125	Overload relay 8...12.5 for CWC025	12450910	\$196.69	\$86.54	
	RW17-2D3-U015	Overload relay 10...15 for CWC025	12450911	\$196.69	\$86.54	
	RW17-2D3-U017	Overload relay 11...17 for CWC025	12450912	\$196.69	\$86.54	
	RW17-2D3-U023	Overload relay 15...23 for CWC025	12450913	\$220.19	\$96.88	
	Contractor	RW17-2D3-U032	Overload relay 22...32 for CWC025	12450914	\$220.19	\$96.88



CWB Series

- RW27 Overload Relays





Tripping class 10, Phase-loss sensibility, Hand/Auto/Reset button, Temperature compensation

	Item number	Description	Vendors Code	Trade Price	Contractor Price	
	RW27-2D3-D004	Overload relay 0.28...0.4 for CWB9-38	12140441	\$223.56	\$98.37	
	RW27-2D3-C063	Overload relay 0.43...0.63 for CWB9-38	12140442	\$223.56	\$98.37	
	RW27-2D3-D008	Overload relay 0.56...0.8 for CWB9-38	12140443	\$223.56	\$98.37	
	RW27-2D3-D012	Overload relay 0.8...1.2 for CWB9-38	12140444	\$223.56	\$98.37	
	RW27-2D3-D018	Overload relay 1.2...1.8 for CWB9-38	12140445	\$223.56	\$98.37	
	RW27-2D3-D028	Overload relay 1.8...2.8 for CWB9-38	12140446	\$223.56	\$98.37	
	RW27-2D3-U004	Overload relay 2.8...4 for CWB9-38	12140447	\$223.56	\$98.37	
	RW27-2D3-D063	Overload relay 4...6.3 for CWB9-38	12140448	\$223.56	\$98.37	
	RW27-2D3-U008	Overload relay 5.6...8 for CWB9-38	12140449	\$223.56	\$98.37	
	RW27-2D3-U010	Overload relay 7...10 for CWB9-38	12140450	\$229.59	\$101.02	
	RW27-2D3-D125	Overload relay 8...12.5 for CWB9-38	12140451	\$229.59	\$101.02	
	RW27-2D3-U015	Overload relay 10...15 for CWB9-38	12140452	\$247.03	\$108.69	
	RW27-2D3-U017	Overload relay 11...17 for CWB9-38	12140453	\$247.03	\$108.69	
	RW27-2D3-U023	Overload relay 15...23 for CWB9-38	12140454	\$260.46	\$114.60	
	RW27-2D3-U032	Overload relay 22...32 for CWB9-38	12140455	\$361.16	\$158.91	
	RW27-2D3-U040	Overload relay 32...40 for CWB9-38	12140456	\$361.16	\$158.91	
		RW67-5D3-U040	Overload relay 25...40 for CWB40-80	13368960	\$463.20	\$203.81
		RW67-5D3-U050	Overload relay 32...50 for CWB40-80	13368961	\$569.26	\$250.47
		RW67-5D3-U057	Overload relay 40...57 for CWB40-80	13368962	\$573.29	\$252.25
	RW67-5D3-U063	Overload relay 50...63 for CWB40-80	13368963	\$582.69	\$256.38	
	RW67-5D3-U070	Overload relay 57...70 for CWB40-80	13368964	\$597.45	\$262.88	
	RW67-5D3-U080	Overload relay 63...80 for CWB40-80	13368965	\$602.83	\$265.25	
	Accessories					
Contractor	BF27-2D	Mounting Base for RW27-2D / RWB40	13598034	\$59.54	\$26.20	
	BF67-5D	Mounting Base for RW67-5D	13369075	\$134.86	\$59.34	



CWM Series

- RWxx Overload Relays

	Item number	Description	SAP number	Trade Price	Contractor Price
	RW27-1D3-D004	Overload relay 0.28...0.4 for CWM 9 - 25	10045630	\$256.43	\$112.83
	RW27-1D3-C063	Overload relay 0.43...0.63 for CWM 9 - 25	10186032	\$256.43	\$112.83
	RW27-1D3-D008	Overload relay 0.56...0.8 for CWM 9 - 25	10186033	\$256.43	\$112.83
	RW27-1D3-D012	Overload relay 0.8...1.2 for CWM 9 - 25	10045631	\$256.43	\$112.83
	RW27-1D3-D018	Overload relay 1.2...1.8 for CWM 9 - 25	10045632	\$256.43	\$112.83
	RW27-1D3-D028	Overload relay 1.8...2.8 for CWM 9 - 25	10452548	\$256.43	\$112.83
	RW27-1D3-U004	Overload relay 2.8...4 for CWM 9 - 25	10452213	\$256.43	\$112.83
	RW27-1D3-D063	Overload relay 4...6.3 for CWM 9 - 25	10045633	\$256.43	\$112.83
	RW27-1D3-U008	Overload relay 5.6...8 for CWM 9 - 25	10452197	\$256.43	\$112.83
	RW27-1D3-U010	Overload relay 7...10 for CWM 9 - 25	10045634	\$229.59	\$101.02
	RW27-1D3-D125	Overload relay 8...12.5 for CWM 9 - 25	10452967	\$229.59	\$101.02
	RW27-1D3-U015	Overload relay 10...15 for CWM 9 - 25	10452384	\$229.59	\$101.02
RW27-1D3-U017	Overload relay 11...17 for CWM 9 - 25	10452204	\$247.03	\$108.69	
RW27-1D3-U023	Overload relay 15...23 for CWM 9 - 25	10452205	\$260.46	\$114.60	
	RW27-1D3-U032	Overload relay 22...32 for CWM 9 - 32	10452382	\$361.16	\$158.91
	RW27-1D3-U040	Overload relay 25 ... 40A for CWM 32 - 40	10452216	\$402.10	\$176.92
	RW67-1D3-U050	Overload relay 32 ... 50A for CWM 32 - 40	10452217	\$520.92	\$229.20
	RW67-2D3-U040	Overload relay 25 ... 40A for CWM 50 - 80	10844133	\$441.72	\$194.36
	RW67-2D3-U050	Overload relay 32 ... 50A for CWM 50 - 80	10186035	\$520.92	\$229.20
	RW67-2D3-U057	Overload relay 40 ... 57A for CWM 50 - 80	10452201	\$520.92	\$229.20
	RW67-2D3-U063	Overload relay 50 ... 63A for CWM 50 - 80	10452218	\$542.41	\$238.66
	RW67-2D3-U070	Overload relay 57 ... 70A for CWM 50 - 80	10045635	\$601.48	\$264.65
	RW67-2D3-U080	Overload relay 63 ... 80A for CWM 50 - 80	10045636	\$601.48	\$264.65
	RW117-1D3-U080	Overload relay 63 ... 80A for CWM 95 - 105	10186370	\$659.34	\$290.11
	RW117-1D3-U097	Overload relay 75 ... 97A for CWM 95 - 105	10410002	\$659.34	\$290.11
	RW117-1D3-U112	Overload relay 90 ... 112A for CWM 95 - 105	10410003	\$659.34	\$290.11
	RW117-2D3-U097	Overload relay 75 ... 97A for CWM 112	10045646	\$845.84	\$372.17
	RW117-2D3-U112	Overload relay 90 ... 112A for CWM 112	10410004	\$845.84	\$372.17
	RW317-1D3-U150	Overload relay 100 ... 150A for CWM 112 - 500	10045647	\$1,122.41	\$493.86
	RW317-1D3-U215	Overload relay 140...215A for CWM 112 - 500	10410005	\$1,122.41	\$493.86
	RW317-1D3-U310	Overload relay 200...310A for CWM 112 - 500	10410006	\$1,262.05	\$555.30
	RW317-1D3-U420	Overload relay 275...420A for CWM 112 - 500	10410007	\$1,262.05	\$555.30
	RW407-1D3-U600	Overload relay 400...600A for CWM 500 - 630	10452250	\$2,215.29	\$974.73
Contractor	RW407-1D3-U840	Overload relay 560...840A for CWM 630 - 800	10045637	\$2,416.68	\$1,063.34



CWM Series

- RWxx Overload Relays Accessories

	Item number	Description	SAP number	Trade Price	Contractor Price
	GA67-1D	Set of Terminals for Connection between RW67D + CWM 32 / 40	10186061	\$292.69	\$128.78
	GA67-2D	Set of Terminals for Connection between RW67D + CWM 50 / 65 / 80	10186062	\$292.69	\$128.78
	GA117D	Set of Terminals for Connection between RW117.2D + CWM112	10185899	\$359.83	\$158.33
	GA-317-1D	Set of Terminals for Connection between RW317D + CWM150	10185904	\$265.83	\$116.97
	GA-317-2D	Set of Terminals for Connection between RW317D + CWM180	10185900	\$265.83	\$116.97
	GA-317-3D	Set of Terminals for Connection between RW317D + CWM250/300	10185901	\$476.63	\$209.72
	GA-317-10D	Set of Terminals for Connection between RW317D + CWM400	10187159	\$637.74	\$280.61
	IBRW317	3ph Insulator Barrier for RW317 / RWM420E	11558425	\$52.11	\$22.93
	BMPRW317	Protection Cover for CWM400+RW317/CWM400+RWM420E (set)	13072101	\$336.38	\$148.01
	BMP1RW317-CWM400	Protection Cover for CWM400+RW317/CWM400+RWM420E	13072317	\$224.28	\$98.68
	BF27D	Mounting Base for RW27-1D / RWM40	10410085	\$59.54	\$26.20
	BF67-1D	Mounting Base for RW67-1D	10410086	\$135.17	\$59.47
	BF67-2D	Mounting Base for RW67-2D	10046505	\$135.17	\$59.47
Contractor	BF117D	Mounting Base for RW117-1D	10045719	\$155.59	\$68.46



ELECTRONIC OVERLOAD RELAYS



Flexibility and Versatility



Overload Protection



Phase Loss Protection (≤ 0.05 sec.)



Phase Unbalance Protection



Trip class dip-switch



CWB Series

- RW27 Overload Relays

RWB40 - Electronic Series with 24Vdc reset

Adjustable Tripping class 10, 20 and 30

	Item number	Description	SAP number	Trade Price	Contractor Price
	RWB40E-3-R4U002	Electronic Overload Relay 0.4...2A for CWB9 - 38 (24Vdc reset)	14773637	\$496.93	\$491.96
	RWB40E-3-R4U008	Electronic Overload Relay 1.6...8A for CWB9 - 38 (24Vdc reset)	14773635	\$496.93	\$491.96
	RWB40E-3-R4U025	Electronic Overload Relay 5...25A for CWB9 - 38 (24Vdc reset)	14773632	\$496.93	\$491.96
	RWB40E-3-R4U040	Electronic Overload Relay 8...40A for CWB9 - 38 (24Vdc reset)	14773631	\$496.93	\$491.96

RWB40 - Electronic Series

Adjustable Tripping class 10, 20 and 30

	Item number	Description	SAP number	Trade Price	Contractor Price
	RWB40E-3-A4U002	Electronic Overload Relay 0.4...2A for CWB9 - 38	12786062	\$473.27	\$468.54
	RWB40E-3-A4U008	Electronic Overload Relay 1.6...8A for CWB9 - 38	12786061	\$473.27	\$468.54
	RWB40E-3-A4U025	Electronic Overload Relay 5...25A for CWB9 - 38	12786060	\$473.27	\$468.54
	RWB40E-3-A4U040	Electronic Overload Relay 8...40A for CWB9 - 38	12786059	\$473.27	\$468.54

Accessories

	BF27-2D	Mounting Base for RW27-2D / RWB40	13598034	\$59.54	\$26.20
Contractor	BF67-5D	Mounting Base for RW67-5D	13369075	\$134.86	\$59.34



CWM Series

- RWxx Overload Relays

RWB40 - Electronic Series

Adjustable Tripping class 10, 20 and 30

	Item number	Description	SAP number	Trade Price	Contractor Price
		RWM40E-3-A4U002	Electronic Overload Relay 0.4...2A for CWM9 - 25	11454460	\$473.27
RWM40E-3-A4U008		Electronic Overload Relay 1.6...8A for CWM9 - 25	11454459	\$473.27	\$468.54
RWM40E-3-A4U025		Electronic Overload Relay 5...25A for CWM9 - 25	11454417	\$473.27	\$468.54
RWM40E-3-A4U040		Electronic Overload Relay 8...40A for CWM32 - 40	11373597	\$485.72	\$480.86
RWM112E-3-A4U056		Electronic Overload Relay 14...56A for CWM50 - 105	11114728	\$491.96	\$487.04
RWM112E-3-A4U112		Electronic Overload Relay 28...112A for CWM112	11114729	\$491.96	\$487.04
RWM420E-3-A4U250		Electronic Overload Relay 50...250A for CWM112...400	12802652	\$1,336.90	\$1,323.53
RWM420E-3-A4U420		Electronic Overload Relay 112...420A for CWM500...800	11455846	\$1,470.57	\$1,455.86
Contractor		RWM840E-3-A4U840	Electronic Overload Relay 170...840A for CWM500...800	11455847	\$3,009.61

MPW MOTOR CIRCUIT BREAKERS



High durability



Versions with pushbuttons or rotary knob,
screw and spring terminals



Sensitive to phase loss according to IEC 60947-4-1



Wide range of accessories



Compact combined starter sets



Function of molded-case circuit breaker/fuse
and overload relay in a single product



CWB Series

- MPW Motor Circuit Breakers

Item number	Description	SAP number	Trade Price	Contractor Price
MPW18-3-C016	Thermal-Magnetic Motor circuit breaker 0.10...0.16A for CWB	12429311	\$290.20	\$127.69
MPW18-3-C025	Thermal-Magnetic Motor circuit breaker 0.16...0.25A for CWB	12429312	\$290.20	\$127.69
MPW18-3-D004	Thermal-Magnetic Motor circuit breaker 0.25...0.40A for CWB	12429313	\$290.20	\$127.69
MPW18-3-C063	Thermal-Magnetic Motor circuit breaker 0.40...0.63A for CWB	12429315	\$301.40	\$132.62
MPW18-3-U001	Thermal-Magnetic Motor circuit breaker 0.63...1.0A for CWB	12429317	\$301.40	\$132.62
MPW18-3-D016	Thermal-Magnetic Motor circuit breaker 1.0...1.6A for CWB	12429368	\$301.40	\$132.62
MPW18-3-D025	Thermal-Magnetic Motor circuit breaker 1.6...2.5A for CWB	12429369	\$301.40	\$132.62
MPW18-3-U004	Thermal-Magnetic Motor circuit breaker 2.5...4.0 A for CWB	12429370	\$301.40	\$132.62
MPW18-3-D063	Thermal-Magnetic Motor circuit breaker 4.0...6.3A for CWB	12429371	\$301.40	\$132.62
MPW18-3-U010	Thermal-Magnetic Motor circuit breaker 6.3...10A for CWB	12429372	\$362.43	\$159.47
MPW18-3-U016	Thermal-Magnetic Motor circuit breaker 10...16A for CWB	12429373	\$369.91	\$162.76
MPW18-3-U018	Thermal-Magnetic Motor circuit breaker 12...18A for CWB	12429374	\$386.09	\$169.88
MPW40-3-C016	Thermal-Magnetic Motor circuit breaker 0.10...0.16A for CWB	12428084	\$345.05	\$151.82
MPW40-3-C025	Thermal-Magnetic Motor circuit breaker 0.16...0.25A for CWB	12428085	\$345.05	\$151.82
MPW40-3-D004	Thermal-Magnetic Motor circuit breaker 0.25...0.40A for CWB	12428086	\$345.05	\$151.82
MPW40-3-C063	Thermal-Magnetic Motor circuit breaker 0.40...0.63A for CWB	12428087	\$361.16	\$158.91
MPW40-3-U001	Thermal-Magnetic Motor circuit breaker 0.63...1.0A for CWB	12429239	\$361.16	\$158.91
MPW40-3-D016	Thermal-Magnetic Motor circuit breaker 1.0...1.6A for CWB	12428108	\$361.16	\$158.91
MPW40-3-D025	Thermal-Magnetic Motor circuit breaker 1.6...2.5A for CWB	12428110	\$361.16	\$158.91
MPW40-3-U004	Thermal-Magnetic Motor circuit breaker 2.5...4.0A for CWB	12428112	\$361.16	\$158.91
MPW40-3-D063	Thermal-Magnetic Motor circuit breaker 4.0...6.3A for CWB	12428115	\$361.16	\$158.91
MPW40-3-U010	Thermal-Magnetic Motor circuit breaker 6.3...10A for CWB	12428117	\$418.89	\$184.31
MPW40-3-U016	Thermal-Magnetic Motor circuit breaker 10...16A for CWB	12428128	\$432.32	\$190.22
MPW40-3-U020	Thermal-Magnetic Motor circuit breaker 16...20A for CWB	12428129	\$550.46	\$242.20
MPW40-3-U025	Thermal-Magnetic Motor circuit breaker 20...25A for CWB	12428133	\$571.94	\$251.65
MPW40-3-U032	Thermal-Magnetic Motor circuit breaker 25...32A for CWB	12428131	\$571.94	\$251.65
MPW40-3-U040	Thermal-Magnetic Motor circuit breaker 32...40A for CWB	12382551	\$784.07	\$344.99
MPW80-3-U040	Thermal-Magnetic Motor circuit breaker 32...40A for CWB40...80	12425347	\$1,141.58	\$502.30
MPW80-3-U050	Thermal-Magnetic Motor circuit breaker 40...50A for CWB40...80	12425428	\$1,188.81	\$523.08
MPW80-3-U065	Thermal-Magnetic Motor circuit breaker 50...65A for CWB40...80	12425429	\$1,262.05	\$555.30
MPW80-3-U080	Thermal-Magnetic Motor circuit breaker 65...80A for CWB40...80	12501063	\$1,343.30	\$591.05
MPW40i-3-D063	Magnetic Motor circuit breaker 6.3A for CWB	12428178	\$335.09	\$147.44
MPW40i-3-U010	Magnetic Motor circuit breaker 10A for CWB	12428179	\$392.82	\$172.84
MPW40i-3-U016	Magnetic Motor circuit breaker 16A for CWB	12428180	\$406.26	\$178.75
MPW40i-3-U020	Magnetic Motor circuit breaker 20A for CWB	12428181	\$524.40	\$230.74
MPW40i-3-U025	Magnetic Motor Circuit Breaker 25A For CWB	12428182	\$537.04	\$236.30
MPW40i-3-U032	Magnetic Motor circuit breaker 32A for CWB	12428183	\$592.08	\$260.52
MPW40i-3-U040	Magnetic Motor circuit breaker 40A for CWB	12382552	\$626.99	\$275.88
MPW80i-3-U040	Magnetic Motor circuit breaker 40A for CWB40...80	12425431	\$1,107.29	\$487.21
MPW80i-3-U050	Magnetic Motor circuit breaker 50A for CWB40...80	12425432	\$1,153.16	\$507.39
MPW80i-3-U065	Magnetic Motor circuit breaker 65A for CWB40...80	12425434	\$1,153.16	\$507.39
Contractor MPW80i-3-U080	Magnetic Motor circuit breaker 80A for CWB40...80	12501066	\$1,303.05	\$573.34





CWB Series - MPW Motor Circuit Breakers Accessories

	Item number	Description	Vendors Code	Trade Price	Contractor Price
	ACBF-11CWB	Aux. Contact Block - Front Mount (1NO + 1NC screw) for MPW18 - MPW80	12463886	\$38.27	\$23.73
	ACBS-11CWB	Aux. Contact Block - Side Mount (1NO + 1NC) for MPW18 - MPW65	12463909	\$38.27	\$23.73
	ACBS-20CWB	Aux. Contact Block - Side Mount (2NO) for MPW18 - MPW65	12463912	\$38.27	\$23.73
	ACBS-02CWB	Aux. Contact Block - Side Mount (2NC) for MPW18 - MPW65	12463914	\$38.27	\$23.73
	(1) CLT32	Current limiter for MPW40	12462918	\$253.07	\$156.90
	BBS45-2	45 mm busbar Adapt for 2 units for MPW18, 40 (63A)	13451023	\$66.05	\$40.95
	BBS45-3	45 mm busbar Adapt for 3 units for MPW18, 40 (63A)	13451024	\$86.40	\$53.57
	BBS45-4	45 mm busbar Adapt for 4 units for MPW18, 40 (63A)	13451025	\$106.74	\$66.18
	BBS45-5	45 mm busbar Adapt for 5 units for MPW18, 40 (63A)	13451026	\$127.06	\$78.78
	BBS54-2	54 mm busbar Adapt for 2 units + side Mount aux. block for MPW18, 40 (63A)	13451027	\$70.75	\$43.87
	BBS54-3	54 mm busbar Adapt for 3 units + side Mount aux. block for MPW18, 40 (63A)	13451168	\$81.29	\$50.40
	BBS54-4	54 mm busbar Adapt for 4 units + side Mount aux. block for MPW18, 40 (63A)	13451169	\$91.83	\$56.93
	BBS54-5	54 mm busbar Adapt for 5 units + side Mount aux. block for MPW18, 40 (63A)	13451170	\$102.37	\$63.47
	CSD	Protection Cover for BBS busbar	10073627	\$28.20	\$17.48
	FTBBS	Feeder terminal for MPW18, 40	13451171	\$72.23	\$44.78
	LST25	Starter type "E" for MPW18, 40	10047102	\$110.41	\$68.45
	TSBF	Trip signalling block for MPW40	12463916	\$100.28	\$62.17
	URMPV37CWB	Undervoltage Release 230-240 V 50 Hz / 277 V 60 Hz for MPW18, 40	12463880	\$148.37	\$91.99
	URMPV47CWB	Undervoltage Release 400-415 V 50 Hz / 480 V 60 Hz for MPW18, 40	12463883	\$148.37	\$91.99
	URMPD02CWB	Undervoltage Release 24 V 50/60 Hz for MPW18, 40	12463884	\$148.37	\$91.99
	SRMPD65CWB	Remote Shunt Release 200-240 V 50/60 Hz for MPW18, 40	12463872	\$148.37	\$91.99
	RMMP-130	Door-Coupling Rotary Handle black/grey 130mm shaft for MPW40	10185921	\$212.81	\$131.94
	RMMP-130E	Door-Coupling Rotary Handle red/yellow 130mm shaft for MPW40	10185923	\$219.52	\$136.10
	RMMP-330	Door-Coupling Rotary Handle black/grey 330mm shaft for MPW40	10185922	\$206.09	\$127.78
	RMMP-330E	Door-Coupling Rotary Handle red/yellow 330mm shaft for MPW40	10185924	\$219.52	\$136.10
	ECCMP-C016	Link module for MPW18 to contactor CWC07...16 (AC/DC coil)	10867179	\$23.89	\$14.81
	ECCMP-18B38	Link module for MPW18 to contactor CWB9...38 (AC coil)	12462672	\$23.89	\$14.81
	ECCMP-40B38	Link module for MPW40 to contactor CWB9...38 (AC coil)	12462673	\$23.89	\$14.81
	ECCMP-40B38DC	Link module for MPW40 to contactor CWB9...38 (DC coil)	12462674	\$23.89	\$14.81
	ECCMP-80B80	Link module for MPW80 to contactor CWB40...80 (AC/DC coil)	13520507	\$81.22	\$50.36
	ECCMP-07	Link module for MPW40 to contactor CW07 (AC coil)	10046506	\$23.89	\$14.81
	ECCMP-C0	Link module for MPW40 to contactor CWC07...16 (AC/DC coil)	10047217	\$44.91	\$27.84
	ECCMP-C025	Link module for MPW40 to contactor MPW40 to CWC025 (AC coil)	10689937	\$44.91	\$27.84
	FME55	Front plate IP55 black for MPW40	10186425	\$164.20	\$101.80
	MPE55GN	Enclosure 92W (black rotary handle) for MPW40 IP55	10211953	\$65.12	\$40.37
	MPE55GN-E	Enclosure 92W (red rotary handle) for MPW40 IP55	10211954	\$67.13	\$41.62
	MPLE55GN	Enclosure 109W (black rotary handle) for MPW40 IP55	10211368	\$86.09	\$53.38
	MPLE55GN-E	Enclosure 109W (red rotary handle) for MPW40 IP55	10666540	\$88.54	\$54.89
	MA45DOLMPW	Mounting adapter for direct-on-line starters for MPW18, 40	10073629	\$87.27	\$54.11
	MA90RVSMPW	Mounting adapter for reversing starters for MPW18, 40	10073628	\$110.10	\$68.26
	MA90SDSMPW	Mounting adapter for star-delta starters for MPW18, 40	10073630	\$175.11	\$108.57
Contractor	SCMP	Scale cover for MPW12, 18, 40, 65, 80	10186290	\$2.31	\$1.22

(1) For use with MPW40 up to 32 A.

Prices Exclude GST and are subject to change at any time Ref: V24



CWM Series

- MPWxx Motor Circuit Breaker

	Item number	Description	SAP number	Trade Price	Contractor Price
	MPW65-3-U040	Motor Thermal-Magnetic circuit breaker 32...40A	10583780	\$1,145.14	\$606.92
MPW65-3-U050	Motor Thermal-Magnetic circuit breaker 40...50A	10583781	\$1,190.42	\$630.92	
MPW65-3-U065	Motor Thermal-Magnetic circuit breaker 50...65A	10306746	\$1,264.72	\$670.30	
MPW100-3-U075	Motor Thermal-Magnetic circuit breaker 55...75A	10076551	\$1,964.77	\$1,041.33	
MPW100-3-U090	Motor Thermal-Magnetic circuit breaker 70...90A	10076552	\$2,113.06	\$1,119.92	
MPW100-3-U100	Motor Thermal-Magnetic circuit breaker 80...100A	10047295	\$2,113.06	\$1,119.92	
MPW65i-3-U050	Motor Magnetic circuit breaker 50A	10583762	\$1,158.07	\$613.78	
MPW65i-3-U065	Motor Magnetic circuit breaker 65A	10583763	\$1,158.07	\$613.78	

Accessories

	ACBF-11	Aux. Contact Block - Front Mount (1NO + 1NC screw) for MPW65	10353835	\$38.27	\$20.28
	ACBS-11	Aux. Contact Block - Side Mount (1NO + 1NC) for MPW65	10409821	\$38.27	\$20.28
	ACBS-02	Aux. Contact Block - Side Mount (2NC) for MPW65	10076989	\$38.27	\$20.28
	ACBS-20	Aux. Contact Block - Side Mount (2NO) for MPW65	10045322	\$38.27	\$20.28
	ACBF-11MPW100	Front mount aux. contact block (1NO+1NC) for MPW100	10047296	\$73.08	\$38.73
	ACBS11-MPW100	Side mount aux. contact block (1NO+1NC) for MPW100	10047297	\$110.62	\$58.63
	ACBS20-MPW100	Side mount aux. contact block (2NO) for MPW100	10076555	\$110.62	\$58.63
	ACBS-02-MPW100	Side mount aux. contact block (2NC) for MPW100	10076556	\$110.62	\$58.63
	TSB	Side mount trip signalling block for MPW25, MPW65	10561996	\$100.38	\$53.20
	TSBAT-11MPW100	Side mount trip signalling block for MPW100	10047298	\$123.61	\$65.51
	CLTMPW25	Current Limiter for MPW16, MPW25	10583764	\$224.87	\$119.18
	URMPV37	Under voltage release 230-240 V 50 Hz for MPW16, MPW25, MPW65	10186285	\$148.37	\$78.64
	URMPV47	Under voltage release 400-415 V 50 Hz / 480 V 60 Hz for MPW16, MPW25, MPW65	10657829	\$148.37	\$78.64
	URMPD02	Under voltage release 24 V 50/60 Hz for MPW16, MPW25, MPW65	10666333	\$148.37	\$78.64
	URMPV33MPW100	Under voltage release 220-230 V 50 Hz for MPW100	10186876	\$159.52	\$84.55
	URMPV43MPW100	Under voltage release 380-400 V 50 Hz / 440-460 V 60 Hz for MPW100	10186877	\$159.52	\$84.55
	SRMPD65	Remote shunt release 200-240 V 50/60 Hz for MPW16, MPW25, MPW65	10186275	\$148.37	\$78.64
	SRMPV33MPW100	Remote shunt release 220-230 V 50 Hz for MPW100	10186873	\$159.52	\$84.55
	RMMP65-130	Door coupling rotary handle Black 130-155 shaft length for MPW65/MPW80	11068497	\$212.81	\$112.79
	RMMP65-330	Door coupling rotary handle Black 330-355 shaft length for MPW65/MPW80	11068519	\$238.98	\$126.66
	MRX100-130	Door coupling rotary handle Black 130-155 shaft length for MPW100	11152799	\$312.10	\$165.41
	RMMP65-130E	Door coupling rotary handle Red/yellow 130-155 shaft length for MPW65/MPW80	11068518	\$219.52	\$116.35
	RMMP65-330E	Door coupling rotary handle Red/yellow 330-355 shaft length for MPW65/MPW80	11068520	\$244.35	\$129.51
	MRX100-130E	Door coupling rotary handle Red 130-155 shaft length for MPW100	11152800	\$318.26	\$168.68
	MRMPW100-315	Door coupling rotary handle Grey 220-482 shaft length for MPW100	10609711	\$307.45	\$162.95
	ECCMP-25	Link module for Contactor CWM9...25 to MPW25 / MPW40	10409822	\$23.89	\$12.66
	ECCMP-32	Link module for Contactor CWM32...40 to MPW25 / MPW40	10075736	\$23.89	\$12.66
Contractor	SCMP	Scale cover for MPW12, 18, 40, 65, 80	10186290	\$2.31	\$1.22

DOL

High performance and reliable motor starter.



Range 0.37kW to 18.5kW



Built-In Thermal Overload



Smart Design



All sizes fitted with CWB Contactor



Standard IP66 Enclosure Size 5



UV Protection for Outdoor Use





High Impact Resistance



DOL Starters

Enclosure dimensions: 217 x 114 x 117,5 mm (H x W x D)

230V	Item number	Description	Overload Relay 	SAP number	Trade Price	Contractor Price
		DLW-B9D24P66-R57	CWB DOL Starter IP66 230V coil O/L 0.8 - 1.2A	RW27-2D3-D012	13716048	\$277.92
	DLW-B9D24P66-R58	CWB DOL Starter IP66 230V coil O/L 1.2 - 1.8A	RW27-2D3-D018	13716049	\$277.92	\$172.31
	DLW-B9D24P66-R59	CWB DOL Starter IP66 230V coil O/L 1.8 - 2.8A	RW27-2D3-D028	13716051	\$277.92	\$172.31
	DLW-B9D24P66-R60	CWB DOL Starter IP66 230V coil O/L 2.8 - 4A	RW27-2D3-U004	13716052	\$277.92	\$172.31
	DLW-B9D24P66-R61	CWB DOL Starter IP66 230V coil O/L 4 - 6.3A	RW27-2D3-D063	13601146	\$277.92	\$172.31
	DLW-B9D24P66-R62	CWB DOL Starter IP66 230V coil O/L 5.6 - 8A	RW27-2D3-U008	13601145	\$277.92	\$172.31
	DLW-B9D24P66-R63	CWB DOL Starter IP66 230V coil O/L 7 - 10A	RW27-2D3-U010	13601147	\$277.92	\$172.31
	DLW-B12D24P66-R64	CWB DOL Starter IP66 230V coil O/L 8 - 12.5A	RW27-2D3-D125	13601168	\$283.29	\$175.64
	DLW-B18D24P66-R66	CWB DOL Starter IP66 230V coil O/L 11 - 17A	RW27-2D3-U017	13601170	\$304.77	\$188.96
	DLW-B25D24P66-R67	CWB DOL Starter IP66 230V coil O/L 15 - 23A	RW27-2D3-U023	13601172	\$304.77	\$188.96
	DLW-B32D24P66-R68	CWB DOL Starter IP66 230V coil O/L 22 - 32A	RW27-2D3-U032	13601173	\$502.13	\$311.32
	DLW-B38D24P66-R69	CWB DOL Starter IP66 230V coil O/L 32 - 40A	RW27-2D3-U040	13517132	\$502.13	\$311.32
	DLW-B9D24D66-R57	CWB DOL Starter IP66 230V coil O/L 0.8 - 1.2A (with reset button only)	RW27-2D3-D012	on request	\$273.89	\$169.81
	DLW-B9D24D66-R58	CWB DOL Starter IP66 230V coil O/L 1.2 - 1.8A (with reset button only)	RW27-2D3-D018	on request	\$273.89	\$169.81
	DLW-B9D24D66-R59	CWB DOL Starter IP66 230V coil O/L 1.8 - 2.8A (with reset button only)	RW27-2D3-D028	on request	\$273.89	\$169.81
	DLW-B9D24D66-R60	CWB DOL Starter IP66 230V coil O/L 2.8 - 4A (with reset button only)	RW27-2D3-U004	on request	\$273.89	\$169.81
	DLW-B9D24D66-R61	CWB DOL Starter IP66 230V coil O/L 4 - 6.3A (with reset button only)	RW27-2D3-D063	on request	\$273.89	\$169.81
	DLW-B9D24D66-R62	CWB DOL Starter IP66 230V coil O/L 5.6 - 8A (with reset button only)	RW27-2D3-U008	on request	\$273.89	\$169.81
	DLW-B9D24D66-R63	CWB DOL Starter IP66 230V coil O/L 7 - 10A (with reset button only)	RW27-2D3-U010	on request	\$273.89	\$169.81
	DLW-B12D24D66-R64	CWB DOL Starter IP66 230V coil O/L 8 - 12.5A (with reset button only)	RW27-2D3-D125	13814203	\$279.27	\$173.15
	DLW-B18D24D66-R66	CWB DOL Starter IP66 230V coil O/L 11 - 17A (with reset button only)	RW27-2D3-U017	13839769	\$300.75	\$186.47
	DLW-B25D24D66-R67	CWB DOL Starter IP66 230V coil O/L 15 - 23A (with reset button only)	RW27-2D3-U023	13839771	\$304.77	\$188.96
	DLW-B32D24D66-R68	CWB DOL Starter IP66 230V coil O/L 22 - 32A (with reset button only)	RW27-2D3-U032	13839773	\$502.13	\$311.32
	DLW-B38D24D66-R69	CWB DOL Starter IP66 230V coil O/L 32 - 40A (with reset button only)	RW27-2D3-U040	on request	\$502.13	\$311.32
400V	Item number	Description	Overload Relay 	SAP number	Trade Price	Contractor Price
	DLW-B9D34P66-R57	CWB DOL Starter IP66 400V coil O/L 0.8 - 1.2A	RW27-2D3-D012	13716057	\$277.92	\$172.31
	DLW-B9D34P66-R58	CWB DOL Starter IP66 400V coil O/L 1.2 - 1.8A	RW27-2D3-D018	13716056	\$277.92	\$172.31
	DLW-B9D34P66-R59	CWB DOL Starter IP66 400V coil O/L 1.8 - 2.8A	RW27-2D3-D028	13339039	\$277.92	\$172.31
	DLW-B9D34P66-R60	CWB DOL Starter IP66 400V coil O/L 2.8 - 4A	RW27-2D3-U004	13716054	\$277.92	\$172.31
	DLW-B9D34P66-R61	CWB DOL Starter IP66 400V coil O/L 4 - 6.3A	RW27-2D3-D063	13601176	\$277.92	\$172.31
	DLW-B9D34P66-R62	CWB DOL Starter IP66 400V coil O/L 5.6 - 8A	RW27-2D3-U008	13601177	\$277.92	\$172.31
	DLW-B9D34P66-R63	CWB DOL Starter IP66 400V coil O/L 7 - 10A	RW27-2D3-U010	13339045	\$277.92	\$172.31
	DLW-B12D34P66-R64	CWB DOL Starter IP66 400V coil O/L 8 - 12.5A	RW27-2D3-D125	13338985	\$283.29	\$175.64
	DLW-B18D34P66-R66	CWB DOL Starter IP66 400V coil O/L 11 - 17A	RW27-2D3-U017	13601191	\$304.77	\$188.96
	DLW-B25D34P66-R67	CWB DOL Starter IP66 400V coil O/L 15 - 23A	RW27-2D3-U023	13601193	\$304.77	\$188.96
	DLW-B32D34P66-R68	CWB DOL Starter IP66 400V coil O/L 22 - 32A	RW27-2D3-U032	13601194	\$502.13	\$311.32
Contractor	DLW-B38D34P66-R69	CWB DOL Starter IP66 400V coil O/L 32 - 40A	RW27-2D3-U040	13601195	\$502.13	\$311.32

Prices Exclude GST and are subject to change at any time Ref: V24



Star/Delta Starters

Item number	Description	SAP number	Trade Price	Contractor Price
Control Voltage 240Vac				
ESDW-7.5D25A65VD0	7.5kW Enclosed Star/Delta Starter 240Vac IP65	10076326	\$2,007.19	\$1,244.46
ESDW-11D25A65VD0	11kW Enclosed Star/Delta Starter 240Vac IP65	10076327	\$2,007.19	\$1,244.46
ESDW-15D25A65VD0	15kW Enclosed Star/Delta Starter 240Vac IP65	10076330	\$2,201.86	\$1,365.15
ESDW-18.5D25A65VD0	18.5kW Enclosed Star/Delta Starter 240Vac IP65	10076333	\$2,201.86	\$1,365.15
ESDW-22D25A65VD0	22kW Enclosed Star/Delta Starter 240Vac IP65	10076334	\$2,201.86	\$1,365.15
ESDW-30D25A65VD0	30kW Enclosed Star/Delta Starter 240Vac IP65	10076335	\$2,928.21	\$1,815.49
ESDW-37D25A65VD0	37kW Enclosed Star/Delta Starter 240Vac IP65	10076328	\$2,928.21	\$1,815.49
ESDW-45D25A65VD0	45kW Enclosed Star/Delta Starter 240Vac IP65	10076329	\$3,251.78	\$2,016.10
ESDW-55D25A65VD0	55kW Enclosed Star/Delta Starter 240Vac IP65	10076331	\$3,453.16	\$2,140.96
ESDW-75D25A65VD0	75kW Enclosed Star/Delta Starter 240Vac IP65	10076332	\$4,555.42	\$2,824.36
Control Voltage 415Vac				
ESDW-7.5D35A65	7.5kW Enclosed Star/Delta Starter 415Vac IP65	10717018	\$2,007.19	\$1,244.46
ESDW-11D35A65	11kW Enclosed Star/Delta Starter 415Vac IP65	10076317	\$2,007.19	\$1,244.46
ESDW-15D35A65	15kW Enclosed Star/Delta Starter 415Vac IP65	10076318	\$2,201.86	\$1,365.15
ESDW-18.5D35A65	18.5kW Enclosed Star/Delta Starter 415Vac IP65	10076319	\$2,201.86	\$1,365.15
ESDW-22D35A65	22kW Enclosed Star/Delta Starter 415Vac IP65	10076320	\$2,201.86	\$1,365.15
ESDW-30D35A65	30kW Enclosed Star/Delta Starter 415Vac IP65	10076321	\$2,928.21	\$1,815.49
ESDW-37D35A65	37kW Enclosed Star/Delta Starter 415Vac IP65	10076322	\$2,928.21	\$1,815.49
ESDW-45D35A65	45kW Enclosed Star/Delta Starter 415Vac IP65	10076323	\$3,251.78	\$2,016.10
ESDW-55D35A65	55kW Enclosed Star/Delta Starter 415Vac IP65	10076324	\$3,453.16	\$2,140.96
ESDW-75D35A65	75kW Enclosed Star/Delta Starter 415Vac IP65	10076325	\$4,555.42	\$2,824.36
Control Voltage 240Vac				
OSDW-7.5D25A00	7.5kW Open Star/Delta Starter 240Vac	10949360	\$1,098.24	\$680.91
OSDW-11D25A00	11kW Open Star/Delta Starter 240Vac	10948923	\$1,098.24	\$680.91
OSDW-15D25A00	15kW Open Star/Delta Starter 240Vac	10948925	\$1,584.26	\$982.24
OSDW-18.5D25A00	18.5kW Open Star/Delta Starter 240Vac	10948927	\$1,584.26	\$982.24
OSDW-22D25A00	22kW Open Star/Delta Starter 240Vac	10949059	\$1,584.26	\$982.24
OSDW-30D25A00	30kW Open Star/Delta Starter 240Vac	10949204	\$1,980.33	\$1,227.80
OSDW-37D25A00	37kW Open Star/Delta Starter 240Vac	10949205	\$2,036.95	\$1,262.91
OSDW-45D25A00	45kW Open Star/Delta Starter 240Vac	10949206	\$2,448.11	\$1,517.83
OSDW-55D25A00	55kW Open Star/Delta Starter 240Vac	10949358	\$2,599.95	\$1,611.97
OSDW-75D25A00	75kW Open Star/Delta Starter 240Vac	10949359	\$3,970.30	\$2,461.59
Control Voltage 415Vac				
OSDW-7.5D35A00	7.5kW Open Star/Delta Starter 415Vac	10949402	\$1,098.24	\$680.91
OSDW-11D35A00	11kW Open Star/Delta Starter 415Vac	10949361	\$1,584.26	\$982.24
OSDW-15D35A00	15kW Open Star/Delta Starter 415Vac	10949362	\$1,584.26	\$982.24
OSDW-18.5D35A00	18.5kW Open Star/Delta Starter 415Vac	10949365	\$1,584.26	\$982.24
OSDW-22D35A00	22kW Open Star/Delta Starter 415Vac	10949366	\$1,584.26	\$982.24
OSDW-30D35A00	30kW Open Star/Delta Starter 415Vac	10949367	\$1,980.33	\$1,227.80
OSDW-37D35A00	37kW Open Star/Delta Starter 415Vac	10949398	\$2,036.95	\$1,262.91
OSDW-45D35A00	45kW Open Star/Delta Starter 415Vac	10949399	\$2,448.11	\$1,517.83
OSDW-55D35A00	55kW Open Star/Delta Starter 415Vac	10949400	\$2,599.95	\$1,611.97
OSDW-75D35A00	75kW Open Star/Delta Starter 415Vac	10949401	\$3,970.30	\$2,461.59

Contractor

ELECTRONIC RELAYS



-  LEDs for status indication
-  Simple configuration and operation
-  Easy to adjust
-  High-reliability contacts
-  Excellent precision and repeatability
-  Direct mounting on DIN rail or fixed with screws and PLMP accessory
-  22.5mm compact housing



Electronic Relays

High precision electronic circuit with noise immunity; Compact, with a 22.5mm width frame, direct mounting on DIN rail 35mm or fixed with screws; Equipped with reliability LED for status indications.

	Item number	Description	SAP number	Trade Price	Contractor Price
	RTW17-A01MATE05	On delay time relay 0.1s...10d (1NOC) multi-voltage	13960960	\$199.24	\$141.46
RTW17-Ba02MATE05	Off delay time relay 0.1s...10d (2NOC) multi-voltage	13960938	\$233.61	\$165.86	
ERWT-MF1-02MT1E05	Multifunction time relay 0.1s...10d (2NOC) multi-voltage	11593741	\$388.18	\$275.61	
RTW17-Dc02U003SE05	Pulse Flasher Time relay Start ON 0.3sec...3sec (2NOC) multi-voltage	13960092	\$281.94	\$200.18	
RTW17-Dc02U010SE05	Pulse Flasher Time relay Start ON 1sec...10sec (2NOC) multi-voltage	13960093	\$281.94	\$200.18	
RTW17-Dc02U030SE05	Pulse Flasher Time relay Start ON 3sec...30sec (2NOC) multi-voltage	13960023	\$281.94	\$200.18	
RTW17-Dc02U060SE05	Pulse Flasher Time relay Start ON 6sec...60sec (2NOC) multi-voltage	13960022	\$281.94	\$200.18	
RTW17-Dc02U100SE05	Pulse Flasher Time relay Start ON 10sec...100sec (2NOC) multi-voltage	13960021	\$281.94	\$200.18	
RTW17-Dc02U300SE05	Pulse Flasher Time relay Start ON 30sec...300sec (2NOC) multi-voltage	13960020	\$281.94	\$200.18	
RTW17-Dc02U030ME05	Pulse Flasher Time relay Start ON 3min...30min (2NOC) multi-voltage	13960094	\$281.94	\$200.18	
RTW17-Dd02U003SE05	Pulse Flasher Time relay Start OFF 0.3sec...3sec (2NOC) multi-voltage	13960113	\$281.94	\$200.18	
RTW17-Dd02U010SE05	Pulse Flasher Time relay Start OFF 1sec...10sec (2NOC) multi-voltage	13960114	\$281.94	\$200.18	
RTW17-Dd02U030SE05	Pulse Flasher Time relay Start OFF 3sec...30sec (2NOC) multi-voltage	13960116	\$281.94	\$200.18	
RTW17-Dd02U060SE05	Pulse Flasher Time relay Start OFF 6sec...60sec (2NOC) multi-voltage	13960117	\$281.94	\$200.18	
RTW17-Dd02U100SE05	Pulse Flasher Time relay Start OFF 10sec...100sec (2NOC) multi-voltage	13960128	\$281.94	\$200.18	
RTW17-Dd02U300SE05	Pulse Flasher Time relay Start OFF 30sec...300sec (2NOC) multi-voltage	13960130	\$281.94	\$200.18	
RTW17-Dd02U030ME05	Pulse Flasher Time relay Start OFF 3min...30min (2NOC) multi-voltage	13960115	\$281.94	\$200.18	
RMW17-FF01D97	Phase loss protect relay 380-415 V ac/ca 50/60 Hz	14226362	\$245.06	\$173.99	
RMW17-FSF01D97	Phase loss and phase sequence protect relay 380-415 V ac/ca 50/60 Hz	14226365	\$257.78	\$183.02	
RMW17-SS01D25	Under voltage and overvoltage protect relay 240 V ac/ca 50/60 Hz	13960221	\$336.99	\$239.26	
RPW-PTCE05	PTC protector relay multi-voltage	10075636	\$296.98	\$210.86	
RTW17-G02MATE05	Star-Delta relay 0.1s...10d (2NOC) multi-voltage	13960131	\$224.50	\$159.40	
RNW-ESE09	Draining electronic level control relay 100-240 V ac/ca 50/60 Hz	10318025	\$273.11	\$193.91	
RNW-ENE09	Filling electronic level control relay 100-240 V ac/ca 50/60 Hz	10318026	\$273.11	\$193.91	

Accessories

	Item number	Description	SAP number	Trade Price	Contractor Price
	PLMP	Push-in-lugs for mounting electronic relay without DIN rail	10185925	\$37.96	\$26.95
	EPW	Pendulum electrode for RNW-ESE09 / RNW-ENE09	10583739	\$56.00	\$39.76
EHW	Stem electrode for RNW-ESE09 / RNW-ENE09	10583740	\$251.62	\$178.65	

SRW SMART RELAYS



USB Port



Reliable operating modes and command



Free programming software



Status LED indicator that simplifies the identification of the operation











User-friendly interface



Unique in the market with 6 digital inputs and 4 outputs



Smart Relays

	Item number	Description	SAP number	Trade Price	Contractor Price
	SRW01-UCE3TE1E47	SRW01 Smart relay with earth leakage and PTC protection + Ethernet/IP (240Vac/dc)	13628769	\$2,033.95	\$1,627.16
	SRW01-UCE3TE1E26	SRW01 Smart relay with earth leakage and PTC protection + Ethernet/IP (24Vac/dc)	14623550	\$2,276.37	\$1,821.10
	SRW01-UCE1TE1E47	SRW01 Smart relay with earth leakage and PTC protection + Modbus-TCP (240Vac/dc)	12105800	\$2,073.37	\$1,658.70
	SRW01-UCE1TE1E26	SRW01 Smart relay with earth leakage and PTC protection + Modbus-TCP (24Vac/dc)	12105806	\$2,315.79	\$1,852.63
	SRW01-UCPE1E47	SRW01 Smart relay with earth leakage protection + Profibus (240Vac/dc)	11072136	\$1,687.08	\$1,349.66
	SRW01-UCPE1E26	SRW01 Smart relay with earth leakage protection + Profibus (24Vac/dc)	11364664	\$1,876.28	\$1,501.02
	SRW01-UCME1E47	SRW01 Smart relay with earth leakage protection + Modbus (240Vac/dc)	11072133	\$1,558.97	\$1,247.18
	SRW01-UCME1E26	SRW01 Smart relay with earth leakage protection + Modbus (24Vac/dc)	11364666	\$1,730.43	\$1,384.34
	SRW01-UCDE1E47	SRW01 Smart relay with earth leakage protection + DeviceNet (240Vac/dc)	11072131	\$1,391.44	\$1,113.15
	SRW01-UCDE1E26	SRW01 Smart relay with earth leakage protection + DeviceNet (24Vac/dc)	11364678	\$1,545.17	\$1,236.14
	SRW01-UCPT1E47	SRW01 Smart relay with PTC protection + Profibus (240Vac/dc)	10673417	\$1,572.76	\$1,258.21
	SRW01-UCPT1E26	SRW01 Smart relay with PTC protection + Profibus (24Vac/dc)	11364658	\$1,698.90	\$1,359.12
	SRW01-UCMT1E47	SRW01 Smart relay with PTC protection + Modbus (240Vac/dc)	10675557	\$1,444.66	\$1,155.73
	SRW01-UCMT1E26	SRW01 Smart relay with PTC protection + Modbus (24Vac/dc)	11364683	\$1,608.24	\$1,286.59
	SRW01-UCDT1E47	SRW01 Smart relay with PTC protection + DeviceNet (240Vac/dc)	10673500	\$1,279.10	\$1,023.28
	SRW01-UCDT1E26	SRW01 Smart relay with PTC protection + DeviceNet (24Vac/dc)	11364632	\$1,419.04	\$1,135.23

Contractor



Smart Relays Accessories

Item number	Description	SAP number	Trade Price	Contractor Price
SRW01-EDU1	SRW01 I/O Expansion Module 24 V dc for SRW01 (6DI + 4DO)	11367104	\$520.31	\$416.25
SRW01-UMC1	SRW01 Current Measuring Unit 0,5...5A	10558179	\$474.98	\$379.98
SRW01-UMC2	SRW01 Current Measuring Unit 1,25...12,5A	10558180	\$486.81	\$389.45
SRW01-UMC3	SRW01 Current Measuring Unit 2,5...25A	10558181	\$506.52	\$405.22
SRW01-UMC4	SRW01 Current Measuring Unit 12,5...125A	10558182	\$743.02	\$594.42
SRW01-UMC5	SRW01 Current Measuring Unit 42...420A	10561132	\$1,011.06	\$808.85
SRW01-UMC6	SRW01 Current Measuring Unit 84...840A	10561133	\$1,355.97	\$1,084.78
SRW01-UMCT1	SRW01 Current and Voltage Measuring Unit 0,5...5A and 35...690 Vac	11751275	\$953.91	\$763.13
SRW01-UMCT2	SRW01 Current and Voltage Measuring Unit 1,25...12,5A and 35...690 Vac	11751274	\$965.73	\$772.58
SRW01-UMCT3	SRW01 Current and Voltage Measuring Unit 2,5...25A and 35...690 Vac	11751276	\$985.44	\$788.35
SRW01-UMCT4	SRW01 Current and Voltage Measuring Unit 12,5...125A and 35...690 Vac	11739009	\$1,221.95	\$977.56
SRW01-UMCT5	SRW01 Current and Voltage Measuring Unit 42...420A and 35...690 Vac	11751277	\$1,489.99	\$1,191.99
SRW01-UMCT6	SRW01 Current and Voltage Measuring Unit 84...840A and 35...690 Vac	11751328	\$1,834.89	\$1,467.91
SRW01-CB0	SRW01 UC-UMC or UC-EDU Connection Cable 60mm	11332922	\$15.77	\$12.62
SRW01-CB1	SRW01 UC-UMC or UC-EDU Connection Cable 120mm	10558183	\$15.77	\$12.62
SRW01-CB2	SRW01 UC-UMC or UC-EDU Connection Cable 500mm	10938235	\$19.71	\$15.77
SRW01-CB3	SRW01 UC-UMC or UC-EDU Connection Cable 2000mm	10558185	\$21.68	\$17.34
SRW01-CB4	SRW01 UC-UMC or UC-EDU Connection Cable 1000mm	11332919	\$23.65	\$18.92
SRW01-USB	SRW01 USB Connection Cable 2000mm	10561134	\$58.03	\$46.42
SRW01-AUSB1	SRW01 Mini USB Cable for Panel Door with Protective Cover IP68 250mm	12171479	\$191.18	\$152.94
SRW01-AUSB2	SRW01 Mini USB Cable for Panel Door with Protective Cover IP68 500mm	12171480	\$275.92	\$220.74
SRW01-CH1	SRW01 UC-HMI Connection Cable 500mm	10558187	\$47.30	\$37.84
SRW01-CH2	SRW01 UC-HMI Connection Cable 1000mm	10558188	\$51.24	\$40.99
SRW01-CH3	SRW01 UC-HMI Connection Cable 1500mm	10558189	\$51.24	\$40.99
SRW01-CH4	SRW01 UC-HMI Connection Cable 2000mm	11332397	\$59.13	\$47.30
COM CABLE	SRW01 HMI Extension Cable	10624678	\$45.33	\$36.26
SRW01-HMI1	SRW01 HMI (vertical)	10558186	\$364.61	\$291.69
SRW01-HMI2	SRW01 HMI (horizontal)	11578238	\$561.70	\$449.36
SRW01-MCD	SRW01 DeviceNet Communication Module	10575286	\$147.82	\$118.26
SRW01-MCM	SRW01 Modbus Communication Module	10675582	\$313.37	\$250.70
SRW01-MCP	SRW01 Profibus Communication Module	10675585	\$441.48	\$353.18
JBL RW407D	Busbar for UMC SRW01-UMC(T)6	10045718	\$478.92	\$383.14
SRW01-EL1	SRW01 Earth Leakage Sensor for UMC1, UMC2 and UMC3 (diam. 35mm)	10997169	\$312.33	\$249.86
SRW01-EL2	SRW01 Earth Leakage Sensor for UMC4 (diam. 70mm)	10997170	\$544.18	\$435.34
SRW01-EL3	SRW01 Earth Leakage Sensor for UMC5 (diam. 120mm)	10997173	\$981.07	\$784.86
SRW01-EL4	SRW01 Earth Leakage Sensor for UMC6 (diam. 210mm)	10997174	\$1,985.31	\$1,588.25
SRW01-CDB	SRW01 DB9 Connector Plastic Protection Cover (x10)	11080360	\$7.88	\$6.30
SRW01-CMU	SRW01 USB Connector Plastic Protection Cover (x10)	11080361	\$11.83	\$9.46
SRW01-CBP	SRW01 HMI Connector Plastic Protection Cover (x10)	11080359	\$19.71	\$15.77

Prices Exclude GST and are subject to change at any time Ref: V24

POWER METERS



MMW03 Multi Meters

- Robustness for Momentary Overloads
- Energy Measurement with 2 Different Power Supplies
- Digital inputs and outputs that provide greater integration of the field signals with the measurements
- Measurement of voltage and current harmonics up to the 51st order with view of the waveform and bar graph of each harmonics. Analysis of the Electric Energy System
- Isolated RS485 port with Modbus RTU protocol for Data Collection and Power Management
- CE certification.



PFW03 Automatic Power Factor Controllers

- Robustness for Momentary Overloads
- 8 to 24 steps, single-phase and three-phase
- Automatic reading and recording by power step and reactive power type (capacitive or inductive)
- Smart monitoring system (DCM) that identifies the capacitor power availability and accurately corrects the power factor,
- Demand Management
- Reliability and Speed in the Maintenance of the Capacitor Bank
- Segmentation of the Power Factor Control and Energy Measurement with 2 Different Power Supplies
- Isolated RS485 port with Modbus RTU protocol
- CE certification



Power Meters

	Item Number	Description	SAP Number	Trade Price	Contractor Price
	Power Meters				
	MMW03	MMW03 Power Meter - Voltage, current and frequency measurement	14386964	\$599.58	\$479.66
	MMW03-CH	MMW03 Power Meter - Multi-measurement, RS485, Modbus RTU	14386967	\$1,095.79	\$876.63
	MMW03-M22CH	MMW03 Energy Analyser - Multi-measurement, 2 digital inputs, 2 digital outputs, RS485, Modbus RTU	14387019	\$1,488.63	\$1,190.90
	MMW03-M22CHB	MMW03 Energy Analyser - Multi-measurement, 2 digital inputs, 2 digital outputs, RS485, recording in memory, harmonic graph, waveform, Modbus RTU	14387025	\$1,695.36	\$1,356.29
	Power Factor Controllers				
	PFW03-M8	PFW03 Automatic Power Factor Controller - Single-Phase, 8-steps	14387138	\$1,199.16	\$959.33
	PFW03-M12	PFW03 Automatic Power Factor Controller - Single-Phase, 12-steps	14387141	\$1,323.21	\$1,058.57
	PFW03-M24	PFW03 Automatic Power Factor Controller - Single-Phase, 24-steps	14387143	\$1,612.67	\$1,290.14
	PFW03-T12	PFW03 Automatic Power Factor Controller - Three-Phase, 12-steps	14387080	\$1,943.47	\$1,554.78
PFW03-T24	PFW03 Automatic Power Factor Controller - Three-Phase, 24-steps	14387086	\$2,356.97	\$1,885.58	
IP66 Protection					
Contractor	MBN96X96	MMW03 / PFW03 IP66 protection 96x96 cover	14432877	\$33.07	\$26.46

ENCLOSURES



Thermal overload relay reset button integrated to the Stop button (sizes 02 up to 05)



Compatible with CSW pushbuttons, switches, and pilot lights (size 05 and 08)



Degree of protection IP65 Protected against dust and water



UV protection for outdoor use



Robust and high impact resistance



Fast and easy installation of cable glands



Enclosed size 05 allows installation of WEG electronic timers (RTW) or monitoring relays (RPW).



Distribution Boards and Enclosures

From 4 up to 36 poles DIN standard circuit breakers

Query for transparent door boards

	Item number	Description	Size [mm] (H x W x D)	SAP number	Trade Price	Contractor Price
	EB10P-IP52	Empty Enclosure IP52 Size 10 with Start/Stop Button	360 x 250 x 167	11176423	\$484.46	\$213.16
	EB02P-IP65	Empty Enclosure IP65 Size 02 (can use with CW07 + RW17-1D)	155 x 90 x 98	10211370	\$89.48	\$39.37
	EB04CP-IP65	Empty Enclosure IP65 Size 04 (can use with CWC07...16 + RW17-1D)	185 x 105 x 111	10726769	\$100.46	\$44.20
	EB04P-IP65	Empty Enclosure IP65 Size 04 (can use with CWM9...25 + RW27-1D)	185 x 105 x 111	10686097	\$100.46	\$44.20
	EB05P-IP66	Empty Enclosure IP66 Size 05 (can use with CWB9...38+RW27-2D)	217 x 114 x 112.5	13517385	\$100.46	\$44.20
	EB06AP-IP65	Empty Enclosure IP65 Size 06 (can use with CWM32/40 + RW27-1D)	210 x 120 x 126	10686096	\$119.74	\$52.69
	EB06BP-IP65	Empty Enclosure IP65 Size 06 (can use with CWM32/40 + RW67-1D)	210 x 120 x 126	10211941	\$119.74	\$52.69
	EB08P-IP65	Empty Enclosure IP65 Size 08 (can use with CWM50...80 + RW67-2D)	280 x 180 x 143	13522896	\$299.27	\$131.68
	EB10P-IP65	Empty Enclosure IP65 Size 10 (can use with CWM95/105 + RW117-1D)	360 x 250 x 167	13522897	\$520.81	\$229.16
	Contractor	EB05D-IP66	Empty Enclosure IP66 Size 05 With Reset Button Only (can use with CWB9...38+RW27-2D)	217 x 114 x 112.5	13698502	\$100.46

PUSHBUTTONS & PILOT LIGHTS



Safe and Reliable



UV Rated



Non-Flammable



Easy Assembly



IP66 Protected against dust and water jets



Self-Cleaning and High-Performance Contact Blocks



Decentralised Control Stations – PBW



Self-Monitoring of Emergency-Stop Buttons







High Performance Illumination Blocks



Pushbuttons and Pilot Lights (Complete Sets)

WEG's pushbuttons and pilot lights series (Ø 22mm), designed for use in severe environments with

IP66 for industrial applications (totally insulated).









	Item Number	Description	SAP Number	Trade Price	Contractor Price
	CSW-BF1-01000000-3VF	Compl. Set Push Button Flush (Red-1NC)	12922955	\$57.25	\$25.19
	CSW-BF2-12000000-3VF	Compl. Set Push Button Flush (Green-1NO)	12923177	\$57.25	\$25.19
	CSW-BF3-10000000-3VF	Compl. Set Push Button Flush (yellow- 1NO)	12930986	\$57.25	\$25.19
	CSW-BF4-10000000-3VF	Compl. Set Push Button Flush (blue- 1NO)	12923199	\$57.25	\$25.19
	CSW-BF5-12000000-3VF	Compl. Set Push Button Flush (black - 1NO)	12923176	\$57.25	\$25.19
	CSW-CK2F90-11000000-3VF	Selector knob 2 fix pos (90°) Complete with 1NO+1NC Contact	12923198	\$103.32	\$45.46
	CSW-CK3F45-20000000-3VF	Selector knob 3 fix pos (45°) Complete with 2NO Contact	12923168	\$104.78	\$46.10
	CSW-BF11-01000000-FD66-3VF	Compl. Set Illuminated Push Button Red with LED 220-240 V ac (1NC)	12931064	\$96.80	\$42.59
	CSW-BF12-10000000-FD66-3VF	Compl. Set Illuminated Push Button Green with LED 220-240 V ac (1NO)	12931067	\$96.80	\$42.59
	CSW-BD-11000000-FD661-3VF	Compl. Set Double Push Button w/ LED 220 V ac red IP40 (1NO+1NC)	12923174	\$132.92	\$58.48
	CSW-SD0-FE26-3VF	Compl. Set Pilot Light Diffused white with LED 24Vac/dc	12930828	\$70.31	\$30.94
	CSW-SD1-FE26-3VF	Compl. Set Pilot Light Diffused red with LED 24Vac/dc	12930829	\$70.31	\$30.94
	CSW-SD2-FE26-3VF	Compl. Set Pilot Light Diffused green with LED 24Vac/dc	12930830	\$70.31	\$30.94
	CSW-SD3-FE26-3VF	Compl. Set Pilot Light Diffused yellow with LED 24Vac/dc	12930831	\$70.31	\$30.94
	CSW-SD4-FE26-3VF	Compl. Set Pilot Light Diffused blue with LED 24Vac/dc	12930832	\$70.31	\$30.94
	CSW-SD6-FE26-3VF	Compl. Set Pilot Light Diffused orange with LED 24Vac/dc	12930833	\$70.31	\$30.94
	CSW-SD0-FD66-3VF	Compl. Set Pilot Light Diffused white with LED 220-240 V ac	12930902	\$70.31	\$30.94
	CSW-SD1-FD66-3VF	Compl. Set Pilot Light Diffused red with LED 220-240 Vac	12923060	\$70.31	\$30.94
	CSW-SD2-FD66-3VF	Compl. Set Pilot Light Diffused green with LED 220-240 Vac	12923059	\$70.31	\$30.94
	CSW-SD3-FD66-3VF	Compl. Set Pilot Light Diffused yellow with LED 220-240Vac	12930903	\$70.31	\$30.94
	CSW-SD4-FD66-3VF	Compl. Set Pilot Light Diffused blue with LED 220-240Vac	12930904	\$70.31	\$30.94
	CSW-SD6-FD66-3VF	Compl. Set Pilot Light Diffused orange with LED 220-240Vac	12930905	\$70.31	\$30.94
	CSW-BESGS-00000001	Compl. Set Emergency stop, lateral ind. turn to reset +1NC self monitoring	13278312	\$172.98	\$76.11
Contractor	CSW-BESPS-00000001	Compl. Set Emergency stop, lateral ind. pull to reset +1NC self monitoring	12198461	\$182.11	\$80.13



Pushbuttons and Pilot Lights (1)

WEG's pushbuttons and pilot lights series (Ø 22mm), designed for use in severe environments with

IP66 for industrial applications (totally insulated).

	Item number	Description	SAP number	Trade Price	Contractor Price		
	CSW-BF1WH	Pushbutton Red(Flush)	12881927	\$25.39	\$11.17		
	CSW-BF2WH	Push button Green (Flush)	12882149	\$25.39	\$11.17		
	CSW-BF3WH	Push button Yellow (Flush)	12882150	\$25.39	\$11.17		
	CSW-BF4WH	Push button Blue (Flush)	12882151	\$25.39	\$11.17		
	CSW-BF5WH	Push button Black (Flush)	12882152	\$25.39	\$11.17		
		CSW-BGA0WH	Push button White (Recessed)	12882154	\$30.53	\$13.43	
		CSW-BGA1WH	Push button Red (Recessed)	12882155	\$30.53	\$13.43	
		CSW-BGA2WH	Push button Green (Recessed)	12882156	\$30.53	\$13.43	
		CSW-BGA3WH	Push button Yellow (Recessed)	12882157	\$30.53	\$13.43	
		CSW-BGA4WH	Push button Blue (Recessed)	12882158	\$30.53	\$13.43	
		CSW-BGA5WH	Push button Black (Recessed)	12882159	\$30.53	\$13.43	
		CSW-BS0WH	Push button White (Extended)	12882167	\$33.57	\$14.77	
		CSW-BS1WH	Push button Red (Extended)	12882208	\$33.57	\$14.77	
		CSW-BS2WH	Push button Green (Extended)	12882210	\$33.57	\$14.77	
		CSW-BS3WH	Push button Yellow (Extended)	12882211	\$33.57	\$14.77	
		CSW-BS4WH	Push button Blue (Extended)	12882212	\$33.57	\$14.77	
		CSW-BS5WH	Push button Black (Extended)	12882213	\$33.57	\$14.77	
		CSW-BHF437	Reset push button with shaft (Min: 22.5 mm Max: 250 mm)	12471376	\$39.91	\$17.56	
			CSW-BF10WH	Illuminated push button White (Flush)	12882258	\$29.68	\$13.06
			CSW-BF11WH	Illuminated push button Red (Flush)	12882259	\$29.68	\$13.06
CSW-BF12WH	Illuminated push button Green (Flush)		12882260	\$29.68	\$13.06		
CSW-BF13WH	Illuminated push button Yellow (Flush)		12882261	\$29.68	\$13.06		
CSW-BF14WH	Illuminated push button Blue (Flush)		12882262	\$29.68	\$13.06		
CSW-BF16WH	Illuminated push button Orange (Flush)		12882264	\$29.68	\$13.06		
	CSW2-BDF1211OWH	Double push button green(l) red(o) Illuminated IP66	12756258	\$50.67	\$22.29		
	CSW2-BDF121SS-WH	Double push button green (START) red(STOP) Illuminated IP66	12904803	\$50.67	\$22.29		
	CSW2-BDF121-WH	Double push button green red blank Illuminated IP66	12904818	\$50.67	\$22.29		
	CSW2-BDF105-WH	Double push button white black blank Illuminated IP66	12904824	\$50.67	\$22.29		
	CSW2-BDF155PN-WH	Double push button white(+) black(-) Illuminated IP66	12904825	\$50.67	\$22.29		
	CSW2-BDF155FR-WH	Double push button white(↑) (↓) on black Illuminated IP66	12904827	\$50.67	\$22.29		
	CSW2-BDS105IO-WH	Double extended push button white(l) black(o) Illuminated IP66	12904837	\$50.67	\$22.29		
	CSW2-BDS121SS-WH	Double extended push button green(START) red(STOP) Illuminated IP66	12904831	\$50.67	\$22.29		
	CSW2-BTF2411ORWH	Triple push button green(l) blue(RESET) red(0) IP66	13120530	\$62.28	\$27.40		
	CSW2-BTF540IORWH	Triple push button black(l) blue(RESET) white(0) IP66	13120531	\$62.28	\$27.40		
	CSW2-BTF540SSRWH	Triple push button black(START) blue(RESET) white(STOP) IP66	13120532	\$62.28	\$27.40		
	CSW2-BTF212FRSWH	Triple push button green(↑) red(STOP) green(↓) IP66	13120359	\$62.28	\$27.40		
Contractor	CSW2-BTF212RLSWH	Triple push button green(→) red(STOP) green(←) IP66	13120358	\$62.28	\$27.40		



Pushbuttons and Pilot Lights (2)

WEG's pushbuttons and pilot lights series (Ø 22mm), designed for use in severe environments with

IP66 for industrial applications (totally insulated).

Item number	Description	SAP number	Trade Price	Contractor Price
CSW-CK2F90WH	Selector knob 2 fix pos (90°)	12882308	\$49.81	\$21.92
CSW-CK2F90WWH	Selector knob 2 fix pos (90°) diagram 2	12904656	\$49.81	\$21.92
CSW-CK2R45WH	Selector knob 2 pos with return (45°)	12882309	\$60.02	\$26.41
CSW-CK2F45WH	Selector knob 2 fix pos (45°)	12882307	\$49.81	\$21.92
CSW-CK3F45WH	Selector knob 3 fix pos (45°)	12882311	\$51.28	\$22.56
CSW-CK3R45WH	Selector knob 3 pos spring return to center (45°)	12882312	\$75.05	\$33.02
CSW-CK3RD45WH	Selector knob 3 pos spring ret. Right to centre (45°)	12882315	\$78.82	\$34.68
CSW-CK3RE45WH	Selector knob 3 pos spring ret. Left to centre (45°)	12882314	\$75.05	\$33.02
CSW-CY2F45WH	Selector knob with key 2 fix pos (45°)	12882344	\$231.81	\$102.00
CSW-CY2R45WH	Selector knob with key 2 pos with return (45°)	12882346	\$231.81	\$102.00
CSW-CY2F90WH	Selector knob with key 2 fix pos (90°)	12882369	\$231.81	\$102.00
CSW-CY2R90WH	Selector knob with key 2 pos with return (90°)	12882370	\$231.81	\$102.00
CSW-CYE2F45WH	Selector knob with key 2 fix pos (45°) left pos key release	13666551	\$231.81	\$102.00
CSW-CYD2F45WH	Selector knob with key 2 fix pos (45°) right pos key release	13835956	\$231.81	\$102.00
CSW-CYE2F90WH	Selector knob with key 2 fix pos (90°) left pos key release	13546069	\$231.81	\$102.00
CSW-CYD2F90WH	Selector knob with key 2 fix pos (90°) right pos key release	13836029	\$231.81	\$102.00
CSW-CY3F45WH	Selector knob with key 3 fix pos (45°)	12882347	\$231.81	\$102.00
CSW-CY3R45WH	Selector knob with key 3 pos with return	12882368	\$231.81	\$102.00
CSW-CYE3F45WH	Selector knob with key 3 fix pos (45°) left pos key release	13356492	\$231.81	\$102.00
CSW-CYD3F45WH	Selector knob with key 3 fix pos (45°) right pos key release	13836032	\$231.81	\$102.00
CSW-CYC3F45WH	Selector knob with key 3 fix pos (45°) center pos key release	13476049	\$231.81	\$102.00
CSW-CYC3RD45WH	Selector knob with key 3 pos spring ret. Right to centre (45°) center pos key release	13341925	\$231.81	\$102.00
CSW-CYE3RD45WH	Selector knob with key 3 pos spring ret. Right to centre (45°) left pos key release	13302285	\$231.81	\$102.00
CSW-CA2F45WH	Selector lever with key 2 fix pos (45°)	12882316	\$189.30	\$83.29
CSW-CA2R45WH	Selector lever with key 2 pos with return (45°)	12882338	\$189.30	\$83.29
CSW-CA2F90WH	Selector lever with key 2 fix pos (90°)	12882317	\$189.30	\$83.29
CSW-CA2R90WH	Selector lever with key 2 pos with return (90°)	12882339	\$189.30	\$83.29
CSW-CA3F45WH	Selector lever 3 fix pos (45°)	12882340	\$189.30	\$83.29
CSW-CA3R45WH	Selector lever 3 pos spring return to center (45°)	12882341	\$189.30	\$83.29
CSW-CA3RE45WH	Selector lever 3 pos spring ret. Left to centre (45°)	12882342	\$189.30	\$83.29
CSW-CA3RD45WH	Selector lever 3 pos spring ret. Right to centre (45°)	12882343	\$189.30	\$83.29

Contractor



Pushbuttons and Pilot Lights (3)

WEG's pushbuttons and pilot lights series (Ø 22mm), designed for use in severe environments with

IP66 for industrial applications (totally insulated).





Item number	Description	SAP number	Trade Price	Contractor Price
CSW-SD0WH	Pilot light White (diffused)	12882465	\$20.93	\$9.21
CSW-SD1WH	Pilot light Red (diffused)	12882466	\$20.93	\$9.21
CSW-SD2WH	Pilot light Green (diffused)	12882467	\$20.93	\$9.21
CSW-SD3WH	Pilot light Yellow (diffused)	12882478	\$20.93	\$9.21
CSW-SD4WH	Pilot light Blue (diffused)	12882479	\$20.93	\$9.21
CSW-SD6WH	Pilot light Orange (diffused)	12882480	\$20.93	\$9.21
CSW-CKI2F900WH	Illuminated Selector Switch 2 fix white	12882374	\$78.35	\$34.47
CSW-CKI2F901WH	Illuminated Selector Switch 2 fix red	12882375	\$78.35	\$34.47
CSW-CKI2F902WH	Illuminated Selector Switch 2 fix green	12882376	\$78.35	\$34.47
CSW-CKI2F903WH	Illuminated Selector Switch 2 fix yellow	12882377	\$86.35	\$37.99
CSW-CKI2F904WH	Illuminated Selector Switch 2 fix blue	12882388	\$86.35	\$37.99
CSW-CKI2F906WH	Illuminated Selector Switch 2 fix orange	12882389	\$86.35	\$37.99
CSW-CKI3F450WH	Illuminated Selector Switch 3 fix white	12882391	\$86.35	\$37.99
CSW-CKI3F451WH	Illuminated Selector Switch 3 fix Red	12882392	\$86.35	\$37.99
CSW-CKI3F452WH	Illuminated Selector Switch 3 fix green	12882393	\$86.35	\$37.99
CSW-CKI3F453WH	Illuminated Selector Switch 3 fix yellow	12882394	\$86.35	\$37.99
CSW-CKI3F454WH	Illuminated Selector Switch 3 fix blue	12882395	\$86.35	\$37.99
CSW-CKI3F456WH	Illuminated Selector Switch 3 fix orange	12882396	\$86.35	\$37.99
CSW-CKI3R450WH	Illuminated Selector Switch 3 pos spring return to center white (45°)	12882397	\$104.73	\$46.08
CSW-CKI3R451WH	Illuminated Selector Switch 3 pos spring return to center red (45°)	12882408	\$104.73	\$46.08
CSW-CKI3R452WH	Illuminated Selector Switch 3 pos spring return to center green (45°)	12882409	\$104.73	\$46.08
CSW-CKI3R453WH	Illuminated Selector Switch 3 pos spring return to center yellow (45°)	12882410	\$104.73	\$46.08
CSW-CKI3R454WH	Illuminated Selector Switch 3 pos spring return to center blue (45°)	12882411	\$104.73	\$46.08
CSW-CKI3R456WH	Illuminated Selector Switch 3 pos spring return to center orange (45°)	12882412	\$104.73	\$46.08
CSW-CKI3RD450WH	Illuminated Selector Switch 3 pos spring ret. Right to centre white (45°)	12882413	\$102.30	\$45.01
CSW-CKI3RD451WH	Illuminated Selector Switch 3 pos spring ret. Right to centre red (45°)	12882414	\$102.30	\$45.01
CSW-CKI3RD452WH	Illuminated Selector Switch 3 pos spring ret. Right to centre green (45°)	12882415	\$102.30	\$45.01
CSW-CKI3RD453WH	Illuminated Selector Switch 3 pos spring ret. Right to centre yellow (45°)	12882416	\$102.30	\$45.01
CSW-CKI3RD454WH	Illuminated Selector Switch 3 pos spring ret. Right to centre blue (45°)	12882417	\$102.30	\$45.01
CSW-CKI3RD456WH	Illuminated Selector Switch 3 pos spring ret. Right to centre orange (45°)	12882438	\$102.30	\$45.01
CSW-CKI3RE450WH	Illuminated Selector Switch 3 pos spring ret. Left to centre white (45°)	12882439	\$102.30	\$45.01
CSW-CKI3RE451WH	Illuminated Selector Switch 3 pos spring ret. Left to centre red (45°)	12882440	\$102.30	\$45.01
CSW-CKI3RE452WH	Illuminated Selector Switch 3 pos spring ret. Left to centre green (45°)	12882441	\$102.30	\$45.01
CSW-CKI3RE453WH	Illuminated Selector Switch 3 pos spring ret. Left to centre yellow (45°)	12882442	\$102.30	\$45.01
CSW-CKI3RE454WH	Illuminated Selector Switch 3 pos spring ret. Left to centre blue (45°)	12882443	\$102.30	\$45.01
CSW-CKI3RE456WH	Illuminated Selector Switch 3 pos spring ret. Left to centre orange (45°)	12882444	\$102.30	\$45.01

Contractor



Pushbuttons and Pilot Lights (4)

WEG's pushbuttons and pilot lights series (Ø 22mm), designed for use in severe environments with **IP66** for industrial applications (totally insulated).

	Item number	Description	SAP number	Trade Price	Contractor Price
	CSW-BC0WH	Mushroom Push button spring return White	12882160	\$58.54	\$25.76
	CSW-BC1WH	Mushroom Push button spring return Red	12882161	\$58.54	\$25.76
	CSW-BC2WH	Mushroom Push button spring return Green	12882162	\$58.54	\$25.76
	CSW-BC3WH	Mushroom Push button spring return Yellow	12882163	\$58.54	\$25.76
	CSW-BC4WH	Mushroom Push button spring return Blue	12882164	\$58.54	\$25.76
	CSW-BC5WH	Mushroom Push button spring return Black	12882166	\$58.54	\$25.76
	CSW-BC10WH	Mushroom Illuminated Push button spring return White	12882301	\$104.73	\$46.08
	CSW-BC11WH	Mushroom Illuminated Push button spring return Red	12882302	\$104.73	\$46.08
	CSW-BC12WH	Mushroom Illuminated Push button spring return Green	12882303	\$104.73	\$46.08
	CSW-BC13WH	Mushroom Illuminated Push button spring return Yellow	12882304	\$104.73	\$46.08
	CSW-BC14WH	Mushroom Illuminated Push button spring return Blue	12882305	\$104.73	\$46.08
	CSW-BC15WH	Mushroom Illuminated Push button spring return Orange	12882306	\$104.73	\$46.08
	CSW-BCT0WH	Mushroom Push button turn to release White	12882214	\$103.37	\$45.48
	CSW-BCT1WH	Mushroom Push button turn to release Red	12882215	\$103.37	\$45.48
	CSW-BCT2WH	Mushroom Push button turn to release Green	12882216	\$103.37	\$45.48
	CSW-BCT3WH	Mushroom Push button turn to release Yellow	12882217	\$103.37	\$45.48
	CSW-BCT4WH	Mushroom Push button turn to release Blue	12882249	\$103.37	\$45.48
	CSW-BCT5WH	Mushroom Push button turn to release Orange	12882250	\$103.37	\$45.48
	CSW-BCY0WH	Mushroom Push button key to release White	12882251	\$178.57	\$78.57
	CSW-BCY1WH	Mushroom Push button key to release Red	12882252	\$178.57	\$78.57
	CSW-BCY2WH	Mushroom Push button key to release Green	12882253	\$178.57	\$78.57
	CSW-BCY3WH	Mushroom Push button key to release Yellow	12882255	\$178.57	\$78.57
	CSW-BCY4WH	Mushroom Push button key to release Blue	12882256	\$178.57	\$78.57
	CSW-BCY5WH	Mushroom Push button key to release Orange	12882257	\$178.57	\$78.57
	CSW-BESGSWH	Emergency Stop button turn to release IP66 with Green Pos. Indic. (42mm)	12882462	\$104.60	\$46.02
	CSW-BESPSWH	Emergency Stop button pull to release IP66 with Green Pos. Indic. (42mm)	12882463	\$113.74	\$50.05
	CSW-BESYSWH	Emergency Stop button key to release IP66 with Green Pos. Indic. (42mm)	12882464	\$219.52	\$96.59
	CSW-BESGSMWH	Emergency Stop button turn to release IP66 with Green Pos. Indic. (42mm) + SMF*	13277423	\$104.60	\$46.02
	CSW-BESPSMWH	Emergency Stop button pull to release IP66 with Green Pos. Indic. (42mm) + SMF*	13277427	\$113.74	\$50.05
	CSW-BESYSMWH	Emergency Stop button key to release IP66 with Green Pos. Indic. (42mm) + SMF*	13277425	\$163.04	\$71.74
Contractor	CSW-BESPSFM-WH	Emergency Stop button turn to release IP66 with Green Pos + front Indic. (42mm) + SMF*	16525740	\$169.89	\$74.75
	CSW-BESGSFM-WH	Emergency Stop button pull to release IP66 with Green Pos + front Indic. (42mm) + SMF*	16525738	\$169.89	\$74.75
	CSW-BESPSFIM-WH	Illuminated Emergency Stop button turn to release IP66 with Green Pos. Indic. (42mm) + SMF*	15730938	\$156.53	\$68.87
	CSW-BESGSFIM-WH	Illuminated Emergency Stop button pull to release IP66 with Green Pos. Indic. (42mm) + SMF*	15730896	\$156.53	\$68.87



Pushbuttons and Pilot Lights Accessories (1)

Item number	Description	SAP number	Trade Price	Contractor Price
BC10F-CSW	Contact Block single (1NO)	12891184	\$21.64	\$9.52
BC01F-CSW	Contact Block single (1NC)	12891186	\$21.64	\$9.52
BCA10F-CSW	Contact Block (1NO early make)	13261897	\$36.78	\$16.18
BCR01F-CSW	Contact Block (1NC late break)	13262008	\$36.78	\$16.18
BR-3PF-CSW	Contact Block latch	13270966	\$32.37	\$14.24
BCM01F-CSW	Contact Block (1NC self monitoring)	13262011	\$58.11	\$25.57
CBCSW	Contact Blocks Tie	13275381	\$9.39	\$4.13
CSW-BIDLF-0D66	Integrated LED block white 220-240Vac	12640053	\$35.05	\$15.42
CSW-BIDLF-1D66	Integrated LED block red 220-240Vac	12640054	\$35.05	\$15.42
CSW-BIDLF-2D66	Integrated LED block green 220-240Vac	12640055	\$35.05	\$15.42
CSW-BIDLF-3D66	Integrated LED block yellow 220-240Vac	12640056	\$35.05	\$15.42
CSW-BIDLF-4D66	Integrated LED block blue 220-240Vac	12640057	\$35.05	\$15.42
CSW-BIDLF-0E26	Integrated LED block white 24Vac/dc	12640017	\$35.05	\$15.42
CSW-BIDLF-1E26	Integrated LED block red 24Vac/dc	12640038	\$35.05	\$15.42
CSW-BIDLF-2E26	Integrated LED block green 24Vac/dc	12640039	\$35.05	\$15.42
CSW-BIDLF-3E26	Integrated LED block yellow 24Vac/dc	12640040	\$35.05	\$15.42
CSW-BIDLF-4E26	Integrated LED block blue 24Vac/dc	12640041	\$35.05	\$15.42
CSW-BIDF	Light Bulb Block ac/dc (Ba9s)	13262009	\$10.76	\$4.73
L6VI-E48-0,6W	6 V ac/dc (Ba9s) Incandescent light bulb for CSW-BIDF	10045241	\$21.88	\$9.63
L12VI-E25-1.8W	12 V ac/dc (Ba9s) Incandescent light bulb for CSW-BIDF	10046387	\$21.88	\$9.63
L24VI-E26-2W	24 V ac/dc (Ba9s) Incandescent light bulb for CSW-BIDF	10045243	\$21.88	\$9.63
L48VI-E27-2W	48 V ac/dc (Ba9s) Incandescent light bulb for CSW-BIDF	10046462	\$21.88	\$9.63
L60VI-E28-1,2W	60 V ac/dc (Ba9s) Incandescent light bulb for CSW-BIDF	10045244	\$21.88	\$9.63
L130VI-E30-2W	130 V ac/dc (Ba9s) Incandescent light bulb for CSW-BIDF	10409537	\$23.00	\$10.12
L220VI-E31-2W	220 V ac/dc - Neon (Ba9s) light bulb for CSW-BIDF	10409538	\$21.88	\$9.63
CSW-BRT4F	Transformer block (380-460 Vac/220-240 Vac)	13275625	\$21.02	\$9.25
AF3F	Flange (3 Pos) for CSW	12670264	\$10.26	\$4.51
AF5F	Flange (5 Pos) for CSW	13268324	\$16.99	\$7.48
ATR	Blank CSW Plug 22mm	10185878	\$7.05	\$3.10
AR30	Reduction ring 30mm to 22mm	10187807	\$9.40	\$4.14
CAF22	Locknut Fixing / Extraction Tool	13218642	\$18.40	\$8.10
CSW-AF22.5	Locknut for 22mm head	10186452	\$6.52	\$2.87
GBES	E-stop pushb protection	13263711	\$52.29	\$23.01
APE-02-ENG	Emergency stop text plate	11315980	\$19.48	\$8.57
SH250	Reset button shaft (Min: 22.5 mm Max: 250 mm)	12470467	\$16.12	\$7.09
APBF	Pushbutton protection for Flush Pushbutton CSW-BF	16374343	\$16.99	\$7.48
APBI	Pushbutton protection for Illum. and Ext. Pushbuttons CSW - BFI, BSI, BS	10075605	\$19.78	\$8.70
APBD	Pushbutton protection for Double Pushbutton IP40 CSW-BD	10046217	\$31.95	\$14.06
AP2BD	Pushbutton protection for Double Pushbutton IP66 CSW2-BD	13253639	\$31.95	\$14.06
AP2BT	Pushbutton protection for Extended Double Pushbutton IP66 CSW2-BDS	13253640	\$31.95	\$14.06
DRCSWACSW	DIN rail adaptor	12846896	\$24.84	\$10.93
ACB0-30	Engraved Cap for Pushbutton Stop function (O) black on white	13694194	\$4.70	\$2.07
ACB0-31	Engraved Cap for Pushbutton Start function (I) black on white	13694195	\$4.70	\$2.07
ACB2-40	Engraved Cap for Pushbutton Stop function (START) black on green	13694253	\$4.70	\$2.07
ACB1-39	Engraved Cap for Pushbutton Start function (STOP) black on red	13694251	\$4.70	\$2.07
ACB0-32	Engraved Cap for Pushbutton direction (→) black on white	10667274	\$4.70	\$2.07
ACB0-33	Engraved Cap for Pushbutton rotation right black on white	13694196	\$4.70	\$2.07
ACB0-34	Engraved Cap for Pushbutton rotation left black on white	13694197	\$4.70	\$2.07
ACB4-37	Engraved Cap for Pushbutton RESET black on blue	13526353	\$4.70	\$2.07
ALBI30	Engraved Cap for Illuminated Pushbutton Stop function (O)	10211962	\$5.24	\$2.31
ALBI31	Engraved Cap for Illuminated Pushbutton Start function (I)	10211963	\$5.24	\$2.31
ALBI32	Engraved Cap for Illuminated Pushbutton direction (→)	10211964	\$5.24	\$2.31
ALBI33	Engraved Cap for Illuminated Pushbutton rotation right	10211965	\$5.24	\$2.31
ALBI34	Engraved Cap for Illuminated Pushbutton rotation left	10211966	\$5.24	\$2.31

Contractor

Prices Exclude GST and are subject to change at any time Ref: V24





Pushbuttons and Pilot Lights Accessories (2)

Item number	Description	SAP number	Trade Price	Contractor Price
PP30	Plate Holder without Inscription Plate (30x50) + gasket	11427388	\$8.33	\$3.67
CAP30	Plate (cream) without text (10x)	12439346	\$26.95	\$11.86
AP30	Plate (red/black) without text (10x)	10045237	\$22.16	\$9.75
AP30-TR1-1	Pre engraved plate black on white (Start) for PP30 plate holder	APP30-TR1-1	\$9.53	\$4.19
AP30-TR1-2	Pre engraved plate black on white (Run) for PP30 plate holder	APP30-TR1-2	\$9.53	\$4.19
AP30-TR1-3	Pre engraved plate black on white (Stop) for PP30 plate holder	APP30-TR1-3	\$9.53	\$4.19
AP30-TR1-4	Pre engraved plate black on white (On) for PP30 plate holder	APP30-TR1-4	\$9.53	\$4.19
AP30-TR1-5	Pre engraved plate black on white (Off) for PP30 plate holder	APP30-TR1-5	\$9.53	\$4.19
AP30-TR1-6	Pre engraved plate black on white (Fault) for PP30 plate holder	APP30-TR1-6	\$9.53	\$4.19
AP30-TR1-7	Pre engraved plate black on white (Manual) for PP30 plate holder	APP30-TR1-7	\$9.53	\$4.19
AP30-TR1-8	Pre engraved plate black on white (Automatic) for PP30 plate holder	APP30-TR1-8	\$9.53	\$4.19
AP30-TR1-9	Pre engraved plate black on white (Up) for PP30 plate holder	APP30-TR1-9	\$9.53	\$4.19
AP30-TR1-10	Pre engraved plate black on white (Down) for PP30 plate holder	APP30-TR1-10	\$9.53	\$4.19
AP30-TR1-11	Pre engraved plate black on white (Fast) for PP30 plate holder	APP30-TR1-11	\$9.53	\$4.19
AP30-TR1-12	Pre engraved plate black on white (Slow) for PP30 plate holder	APP30-TR1-12	\$9.53	\$4.19
AP30-TR1-13	Pre engraved plate black on white (Fwd) for PP30 plate holder	APP30-TR1-13	\$9.53	\$4.19
AP30-TR1-14	Pre engraved plate black on white (Rev) for PP30 plate holder	APP30-TR1-14	\$9.53	\$4.19
AP30-TR1-15	Pre engraved plate black on white (Reset) for PP30 plate holder	APP30-TR1-15	\$9.53	\$4.19
AP30-TR1-16	Pre engraved plate black on white (External Fault) for PP30 plate holder	APP30-TR1-16	\$9.53	\$4.19
AP30-TR1-17	Pre engraved plate black on white (System Fault) for PP30 plate holder	APP30-TR1-17	\$9.53	\$4.19
AP30-TR1-18	Pre engraved plate black on white (VSD Fault) for PP30 plate holder	APP30-TR1-18	\$9.53	\$4.19
AP30-TR1-19	Pre engraved plate black on white (Speed Control) for PP30 plate holder	APP30-TR1-19	\$9.53	\$4.19
AP30-TR1-20	Pre engraved plate black on white (Pump 1 Running) for PP30 plate holder	APP30-TR1-20	\$9.53	\$4.19
AP30-TR1-21	Pre engraved plate black on white (Pump 2 Running) for PP30 plate holder	APP30-TR1-21	\$9.53	\$4.19
AP30-TR1-22	Pre engraved plate black on white (Pump 3 Running) for PP30 plate holder	APP30-TR1-22	\$9.53	\$4.19
AP30-TR1-23	Pre engraved plate black on white (Pump 4 Running) for PP30 plate holder	APP30-TR1-23	\$9.53	\$4.19
AP30-TR1-24	Pre engraved plate black on white (Pump 5 Running) for PP30 plate holder	APP30-TR1-24	\$9.53	\$4.19
AP30-TR1-25	Pre engraved plate black on white (Pump 6 Running) for PP30 plate holder	APP30-TR1-25	\$9.53	\$4.19
AP30-TR1-26	Pre engraved plate black on white (Pump 1 Fault) for PP30 plate holder	APP30-TR1-26	\$9.53	\$4.19
AP30-TR1-27	Pre engraved plate black on white (Pump 2 Fault) for PP30 plate holder	APP30-TR1-27	\$9.53	\$4.19
AP30-TR1-28	Pre engraved plate black on white (Pump 3 Fault) for PP30 plate holder	APP30-TR1-28	\$9.53	\$4.19
AP30-TR1-29	Pre engraved plate black on white (Pump 4 Fault) for PP30 plate holder	APP30-TR1-29	\$9.53	\$4.19
AP30-TR1-30	Pre engraved plate black on white (Pump 5 Fault) for PP30 plate holder	APP30-TR1-30	\$9.53	\$4.19
AP30-TR1-31	Pre engraved plate black on white (Pump 6 Fault) for PP30 plate holder	APP30-TR1-31	\$9.53	\$4.19
AP30-TR1-32	Pre engraved plate black on white (E-Stop Active) for PP30 plate holder	APP30-TR1-32	\$9.53	\$4.19
AP30-TR1-33	Pre engraved plate black on white (Supply Fault) for PP30 plate holder	APP30-TR1-33	\$9.53	\$4.19
AP30-TR1-34	Pre engraved plate black on white (Supply Good) for PP30 plate holder	APP30-TR1-34	\$9.53	\$4.19
AP30-TR1-35	Pre engraved plate black on white (No Earth) for PP30 plate holder	APP30-TR1-35	\$9.53	\$4.19
AP30-TR1-36	Pre engraved plate black on white (Earth Good) for PP30 plate holder	APP30-TR1-36	\$9.53	\$4.19
AP30-TR1-37	Pre engraved plate black on white (Ready) for PP30 plate holder	APP30-TR1-37	\$9.53	\$4.19
AP30-TR1-38	Pre engraved plate black on white (Starting) for PP30 plate holder	APP30-TR1-38	\$9.53	\$4.19
AP30-TR1-39	Pre engraved plate black on white (At Speed) for PP30 plate holder	APP30-TR1-39	\$9.53	\$4.19
AP30-TR1-40	Pre engraved plate black on white (Slowing) for PP30 plate holder	APP30-TR1-40	\$9.53	\$4.19
AP30-TR1-41	Pre engraved plate black on white (Running) for PP30 plate holder	APP30-TR1-41	\$9.53	\$4.19
Contractor AP30-TR1-42	Pre engraved plate black on white (Master) for PP30 plate holder	APP30-TR1-42	\$9.53	\$4.19



Pushbuttons and Pilot Lights Accessories (2)

	Item number	Description	SAP number	Trade Price	Contractor Price
<div style="border: 1px solid black; padding: 2px; text-align: center;"> Off Rem On </div>	AP30-TR2-1	Pre engraved plate black on white (Stop/Start) for PP30 plate holder	APP30-TR2-1	\$9.53	\$4.19
	AP30-TR2-2	Pre engraved plate black on white (Off/On) for PP30 plate holder	APP30-TR2-2	\$9.53	\$4.19
	AP30-TR2-3	Pre engraved plate black on white (Rev/Fwd) for PP30 plate holder	APP30-TR2-3	\$9.53	\$4.19
	AP30-TR2-4	Pre engraved plate black on white (Fault/reset) for PP30 plate holder	APP30-TR2-4	\$9.53	\$4.19
	AP30-TR2-5	Pre engraved plate black on white (Loc/Rem) for PP30 plate holder	APP30-TR2-5	\$9.53	\$4.19
	AP30-TR2-6	Pre engraved plate black on white (Man/Auto) for PP30 plate holder	APP30-TR2-6	\$9.53	\$4.19
	AP30-TR2-7	Pre engraved plate black on white (0-I) for PP30 plate holder	APP30-TR2-7	\$9.53	\$4.19
	AP30-TR2-8	Pre engraved plate black on white (I-II) for PP30 plate holder	APP30-TR2-8	\$9.53	\$4.19
	AP30-TR2-9	Pre engraved plate black on white (Enable Pump genius 0-1) for PP30 plate holder	APP30-TR2-9	\$9.53	\$4.19
	AP30-TR2-10	Pre engraved plate black on white (Enable P1 0-1) for PP30 plate holder	APP30-TR2-10	\$9.53	\$4.19
	AP30-TR2-11	Pre engraved plate black on white (Enable P2 0-1) for PP30 plate holder	APP30-TR2-11	\$9.53	\$4.19
	AP30-TR2-12	Pre engraved plate black on white (Enable P3 0-1) for PP30 plate holder	APP30-TR2-12	\$9.53	\$4.19
	AP30-TR2-13	Pre engraved plate black on white (Enable P4 0-1) for PP30 plate holder	APP30-TR2-13	\$9.53	\$4.19
	AP30-TR2-14	Pre engraved plate black on white (Enable P5 0-1) for PP30 plate holder	APP30-TR2-14	\$9.53	\$4.19
	AP30-TR2-15	Pre engraved plate black on white (Enable P6 0-1) for PP30 plate holder	APP30-TR2-15	\$9.53	\$4.19
	AP30-TR3-1	Pre engraved plate black on white (Loc/Off/Rem) for PP30 plate holder	APP30-TR3-1	\$9.53	\$4.19
	AP30-TR3-2	Pre engraved plate black on white (Rem/Off/On) for PP30 plate holder	APP30-TR3-2	\$9.53	\$4.19
	AP30-TR3-3	Pre engraved plate black on white (Man/Off/Auto) for PP30 plate holder	APP30-TR3-3	\$9.53	\$4.19
	AP30-TR3-4	Pre engraved plate black on white (Rev/Off/Fwd) for PP30 plate holder	APP30-TR3-4	\$9.53	\$4.19
	AP30-TR3-5	Pre engraved plate black on white (I-0-II) for PP30 plate holder	APP30-TR3-5	\$9.53	\$4.19
	AP30-TR3-6	Pre engraved plate black on white (Set point 1 2 3) for PP30 plate holder	APP30-TR3-6	\$9.53	\$4.19
	APP30-129	Pre engraved plate white on black with PP30 plate holder (MANUAL) + gasket	10212528	\$14.16	\$6.23
	APP30-205	Pre engraved plate white on black with PP30 plate holder (AUTO) + gasket	11654292	\$14.16	\$6.23
	APP30-18	Pre engraved plate white on black with PP30 plate holder (STOP) + gasket	10186656	\$14.16	\$6.23
	APP30-17	Pre engraved plate white on black with PP30 plate holder (START) + gasket	10186655	\$14.16	\$6.23
	APP30-16	Pre engraved plate white on black with PP30 plate holder (RUN) + gasket	10211998	\$14.16	\$6.23
	APP30-19	Pre engraved plate white on black with PP30 plate holder (UP) + gasket	10211999	\$14.16	\$6.23
	APP30-02	Pre engraved plate white on black with PP30 plate holder (DOWN) + gasket	10211989	\$14.16	\$6.23
	APP30-10	Pre engraved plate white on black with PP30 plate holder (ON) + gasket	10212532	\$14.16	\$6.23
	APP30-132	Pre engraved plate white on black with PP30 plate holder (OFF) + gasket	10212531	\$14.16	\$6.23
	APP30-14	Pre engraved plate white on black with PP30 plate holder (RESET) + gasket	10212533	\$14.16	\$6.23
	APP30-23	Pre engraved plate white on black with PP30 plate holder (MAN/AUTO) + gasket	10212003	\$14.16	\$6.23
	APP30-27	Pre engraved plate white on black with PP30 plate holder (START/STOP) + gasket	10186658	\$14.16	\$6.23
	APP30-20	Pre engraved plate white on black with PP30 plate holder (FOR/REV) + gasket	10212000	\$14.16	\$6.23
	APP30-24	Pre engraved plate white on black with PP30 plate holder (OFF/ON) + gasket	10212004	\$14.16	\$6.23
	APP30-32	Pre engraved plate white on black with PP30 plate holder (MAN/OFF/AUTO) + gasket	10212007	\$14.16	\$6.23
APP30-269	Pre engraved plate white on black with PP30 plate holder (RES/OFF/RUN) + gasket	13267038	\$14.16	\$6.23	
Contractor	APP30-30	Pre engraved plate white on black with PP30 plate holder (FOR/OFF/REV) + gasket	10186660	\$14.16	\$6.23

Note: other pre engraved plates available on request.



Special items

Ø 22mm, designed for use in severe environments with





IP54 for industrial applications (totally insulated).

Connectors and transducers

	Item number	Description	SAP number	Trade Price	Contractor Price
	TRPT010-420-2	0-10bar Pressure Transducer 4-20mA (two wire)	TRPT010-420-2	\$704.82	\$310.12
	CSW-MCNUSBM-P65	USB 3.0 Port Female-Female Connector 22mm IP54	15987776	\$97.35	\$42.83
	CSW-MCNUSBM-C1.5-P65	USB 2.0 Port Female-Male Connector with 1.5m Cable 22mm IP54	15987777	\$97.35	\$42.83
	CSW-MCNRJ45M-P65	RJ45 Port Female-Female Connector	15987808	\$97.35	\$42.83
	CSW-MPK-M5K	5 kΩ Panel Mount Potentiometer 22mm IP54	15987773	\$208.61	\$91.79
	CSW-MPK-M10K	10 kΩ Panel Mount Potentiometer 22mm IP54	15987774	\$208.61	\$91.79

Switched-Mode Power Supplies 24 V dc

Mounting on DIN rail in the vertical position.

	PSS24-W/0,65	Switched-Mode Power Supplies 24Vdc/15W/0.65A dc (100-240Vac input)	13108240	\$545.83	\$240.17
	PSS24-W/1,3	Switched-Mode Power Supplies 24Vdc/30W/1.3A dc (100-240Vac input)	13108202	\$581.61	\$255.91
	PSS24-W/2,2	Switched-Mode Power Supplies 24Vdc/50W/2.2A dc (100-240Vac input)	13108203	\$727.10	\$319.92
	PSS24-W/3	Switched-Mode Power Supplies 24Vdc/70W/3A dc (100-240Vac input)	13108241	\$930.55	\$409.44
	PSS24-W/5	Switched-Mode Power Supplies 24Vdc/120W/5A dc (100-240Vac input)	13108206	\$1,134.23	\$499.06
	PSS24-W/7,5	Switched-Mode Power Supplies 24Vdc/180W/7.5A dc (100-240Vac input)	13108242	\$1,395.83	\$614.17
	PSS24-W/10	Switched-Mode Power Supplies 24Vdc/240W/10A dc (100-240Vac input)	13108244	\$1,744.83	\$767.73
	Communication Modules				
	USB-RS485-N	RS485/USB, Modbus RTU Converter	14389292	\$413.50	\$330.80
	RS485-ETH-N	RS485/Ethernet, Modbus RTU Converter	14389293	\$1,323.21	\$1,058.57
	Test Switch				
	KEY-E073	Current Transformer (CT) and Potential Transformer (PT) test switch	12392816	\$1,050.19	\$462.08
	Auxiliary Transformer				
	EW34	100VA TSL Control transformer (400Vac/230Vac 0.44A)	EW34	\$387.00	\$309.60
	PX58	400VA TSL Control transformer (400Vac/12Vac 33.3Aac or 24Vac 16.7Aac)	PX58	\$1,024.10	\$819.28
Contractor					



CSW Assembly Configurations

Maximum Recommended Configuration of Contact Blocks for Each Type of Head and Flange

Type of head	Illuminated Selector Switch	Selector Switch	Illuminated Pushbuttons	
Reference	CSW-CKI	CSW-CK, CSW-CA, CSW-CY	CSW2-BDFI, CSW2-BDSI	CSW-BCI, CSW-BD, CSW-BFI, CSW-BSI
Maximum number of contacts	4	6	4	6
AF3F flange (3 pos)				
Maximum number of contacts	4	8	4	6
AF5F flange (5 pos) ¹				

Type of head	Non Illuminated						
Reference	CSW-BESGM, CSW-BESPM, CSW-BESYM	CSW-BESG, CSW-BESP, CSW-BESY	CSW2-BDF, CSW2-BDS	CSW-BF, CSW-BGA	CSW-BC, CSW-BS	CSW-BEG, CSW-BEY, CSW-BCT, CSW-BCY	CSW2-BT
Maximum number of contacts	3	4	4	6	6	6	7
AF3F flange (3 pos)							
Maximum number of contacts	-	-	4	6	6	6	-
AF5F flange (5 pos) ²	-	-					-

Contact Blocks BC10F-CSW
Contact Blocks BC01F-CSW

Self Monitoring contact Blocks BCM01-CSW

X Location Not Permitted

Illumination Blocks BIDLF

CBCSW Contact Blocks Tie

Notes: 1) Only use illumination blocks in the central position of an AF5F flange;
2) Do not use self-monitoring contact blocks on an AF5F flange;
Do not use emergency pushbuttons on an AF5F flange.

Prices Exclude GST and are subject to change at any time Ref: V24



PBW Control Stations

WEG control stations and emergency stop stations, PBW line, are available for a wide range of applications meeting the most demanding requirements of quality, robustness and modular design.

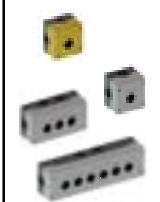
	Item number	Description	SAP number	Trade Price	Contractor Price
	PBW-1Y	Control station Enclosure Yellow (1 hole)	12204334	\$73.84	\$32.49
PBW-1	Control station Enclosure Grey (1 hole)	12204335	\$70.50	\$31.02	
PBW-2	Control station Enclosure Grey (2 hole)	12204336	\$87.27	\$38.40	
PBW-3	Control station Enclosure Grey (3 hole)	12204337	\$104.87	\$46.14	
PBW-4	Control station Enclosure Grey (4 hole)	12204388	\$147.70	\$64.99	
PBW-6	Control station Enclosure Grey (6 hole)	12204389	\$212.13	\$93.34	

Accessories

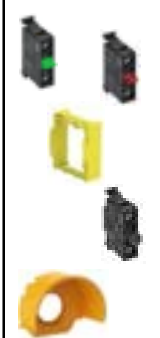
	Item number	Description	SAP number	Trade Price	Contractor Price
	BC10B-CSW	Contact Block single (1NO) for PBW	12174856	\$32.37	\$14.24
BC01B-CSW	Contact Block single (1NC) for PBW	12174857	\$32.37	\$14.24	
CBCSW	Contact Blocks Tie	13275381	\$9.39	\$4.13	
CSW-BIDLB-0E26	Integrated LED block 24Vac/dc white for PBW	12195847	\$48.63	\$21.40	
CSW-BIDLB-1E26	Integrated LED block 24Vac/dc red for PBW	12195918	\$48.63	\$21.40	
CSW-BIDLB-2E26	Integrated LED block 24Vac/dc green for PBW	12195919	\$48.63	\$21.40	
CSW-BIDLB-4E26	Integrated LED block 24Vac/dc blue for PBW	12195921	\$48.63	\$21.40	
CSW-BIDLB-0D66	Integrated LED block 220-240Vac white for PBW	12196008	\$69.41	\$30.54	
CSW-BIDLB-1D66	Integrated LED block 220-240Vac red for PBW	12196009	\$69.41	\$30.54	
CSW-BIDLB-2D66	Integrated LED block 220-240Vac green for PBW	12196010	\$69.41	\$30.54	
CSW-BIDLB-4D66	Integrated LED block 220-240Vac blue for PBW	12196012	\$69.41	\$30.54	

MINIATURE AND RESIDUAL CURRENT CIRCUIT BREAKERS



Safe and Reliable



Easy Installation



Many Optional accessories



B, C and D curve



10kA Circuit Breaker



Applications in several segments:
housing, building and industrial



High Capacity Miniature 10kA Circuit Breakers

Conform IEC 60898

Item number	Description	SAP number	Trade Price	Contractor Price
Single Pole - Curve B, Im = 3 to 5xIn				
MDWH-B6	6A 1pole B 10kA Circuit Breaker	11422529	\$55.22	\$24.30
MDWH-B10	10A 1pole B 10kA Circuit Breaker	11422579	\$55.22	\$24.30
MDWH-B16	16A 1pole B 10kA Circuit Breaker	11422583	\$55.22	\$24.30
MDWH-B20	20A 1pole B 10kA Circuit Breaker	11422587	\$55.22	\$24.30
MDWH-B25	25A 1pole B 10kA Circuit Breaker	11422631	\$55.22	\$24.30
MDWH-B32	32A 1pole B 10kA Circuit Breaker	11422636	\$55.22	\$24.30
MDWH-B40	40A 1pole B 10kA Circuit Breaker	11422640	\$61.34	\$26.99
MDWH-B50	50A 1pole B 10kA Circuit Breaker	11422644	\$118.85	\$52.29
MDWH-B63	63A 1pole B 10kA Circuit Breaker	11422658	\$118.85	\$52.29
MDWH-B80	80A 1pole B 10kA Circuit Breaker	14848969	\$362.46	\$159.48
MDWH-B100	100A 1pole B 10kA Circuit Breaker	14848970	\$362.46	\$159.48
MDWH-B125	125A 1pole B 10kA Circuit Breaker	14848971	\$362.46	\$159.48
Two Pole - Curve B, Im = 3 to 5xIn				
MDWH-B6-2	6A 2pole B 10kA Circuit Breaker	11422543	\$199.71	\$87.87
MDWH-B10-2	10A 2pole B 10kA Circuit Breaker	11422580	\$199.71	\$87.87
MDWH-B16-2	16A 2pole B 10kA Circuit Breaker	11422584	\$199.71	\$87.87
MDWH-B20-2	20A 2pole B 10kA Circuit Breaker	11422628	\$199.71	\$87.87
MDWH-B25-2	25A 2pole B 10kA Circuit Breaker	11422632	\$199.71	\$87.87
MDWH-B32-2	32A 2pole B 10kA Circuit Breaker	11422637	\$199.71	\$87.87
MDWH-B40-2	40A 2pole B 10kA Circuit Breaker	11422641	\$222.01	\$97.68
MDWH-B50-2	50A 2pole B 10kA Circuit Breaker	11422645	\$276.75	\$121.77
MDWH-B63-2	63A 2pole B 10kA Circuit Breaker	11422659	\$276.75	\$121.77
MDWH-B80-2	80A 2pole B 10kA Circuit Breaker	14848972	\$738.46	\$324.92
MDWH-B100-2	100A 2pole B 10kA Circuit Breaker	14848973	\$738.46	\$324.92
MDWH-B125-2	125A 2pole B 10kA Circuit Breaker	14848974	\$738.46	\$324.92
Three Pole - Curve B, Im = 3 to 5xIn				
MDWH-B6-3	6A 3pole B 10kA Circuit Breaker	11422546	\$202.70	\$89.19
MDWH-B10-3	10A 3pole B 10kA Circuit Breaker	11422581	\$202.70	\$89.19
MDWH-B16-3	16A 3pole B 10kA Circuit Breaker	11422585	\$202.70	\$89.19
MDWH-B20-3	20A 3pole B 10kA Circuit Breaker	11422629	\$202.70	\$89.19
MDWH-B25-3	25A 3pole B 10kA Circuit Breaker	11422634	\$202.70	\$89.19
MDWH-B32-3	32A 3pole B 10kA Circuit Breaker	11422638	\$202.70	\$89.19
MDWH-B40-3	40A 3pole B 10kA Circuit Breaker	11422642	\$225.01	\$99.00
MDWH-B50-3	50A 3pole B 10kA Circuit Breaker	11422646	\$344.12	\$151.41
MDWH-B63-3	63A 3pole B 10kA Circuit Breaker	11422660	\$344.12	\$151.41
MDWH-B80-3	80A 3pole B 10kA Circuit Breaker	14848975	\$1,136.92	\$500.24
MDWH-B100-3	100A 3pole B 10kA Circuit Breaker	14848977	\$1,136.92	\$500.24
MDWH-B125-3	125A 3pole B 10kA Circuit Breaker	14849018	\$1,136.92	\$500.24

Contractor



High Capacity Miniature 10kA Circuit Breakers

Conform IEC 60898

Item number	Description	SAP number	Trade Price	Contractor Price
Single Pole - Curve C, Im = 5 to 10xIn				
MDWH-C2	2A 1pole C 10kA Circuit Breaker	13441571	\$59.70	\$26.27
MDWH-C4	4A 1pole C 10kA Circuit Breaker	13441573	\$59.70	\$26.27
MDWH-C6	6A 1pole C 10kA Circuit Breaker	11422662	\$44.89	\$19.75
MDWH-C10	10A 1pole C 10kA Circuit Breaker	11422666	\$44.89	\$19.75
MDWH-C16	16A 1pole C 10kA Circuit Breaker	11422690	\$44.89	\$19.75
MDWH-C20	20A 1pole C 10kA Circuit Breaker	11422694	\$44.89	\$19.75
MDWH-C25	25A 1pole C 10kA Circuit Breaker	11422708	\$44.89	\$19.75
MDWH-C32	32A 1pole C 10kA Circuit Breaker	11422713	\$44.89	\$19.75
MDWH-C40	40A 1pole C 10kA Circuit Breaker	11422717	\$49.88	\$21.95
MDWH-C50	50A 1pole C 10kA Circuit Breaker	11422722	\$71.79	\$31.59
MDWH-C63	63A 1pole C 10kA Circuit Breaker	11422727	\$71.79	\$31.59
MDWH-C80	80A 1pole C 10kA Circuit Breaker	14849019	\$362.46	\$159.48
MDWH-C100	100A 1pole C 10kA Circuit Breaker	14849020	\$362.46	\$159.48
MDWH-C125	125A 1pole C 10kA Circuit Breaker	14849021	\$362.46	\$159.48
Two Pole - Curve C, Im = 5 to 10xIn				
MDWH-C2-2	2A 2pole C 10kA Circuit Breaker	13441574	\$133.64	\$58.80
MDWH-C4-2	4A 2pole C 10kA Circuit Breaker	13441575	\$133.64	\$58.80
MDWH-C6-2	6A 2pole C 10kA Circuit Breaker	11422663	\$133.64	\$58.80
MDWH-C10-2	10A 2pole C 10kA Circuit Breaker	11422667	\$133.64	\$58.80
MDWH-C16-2	16A 2pole C 10kA Circuit Breaker	11422691	\$133.64	\$58.80
MDWH-C20-2	20A 2pole C 10kA Circuit Breaker	11422695	\$133.64	\$58.80
MDWH-C25-2	25A 2pole C 10kA Circuit Breaker	11422709	\$133.64	\$58.80
MDWH-C32-2	32A 2pole C 10kA Circuit Breaker	11422714	\$133.64	\$58.80
MDWH-C40-2	40A 2pole C 10kA Circuit Breaker	11422719	\$214.22	\$94.26
MDWH-C50-2	50A 2pole C 10kA Circuit Breaker	11422723	\$214.22	\$94.26
MDWH-C63-2	63A 2pole C 10kA Circuit Breaker	11422728	\$214.22	\$94.26
MDWH-C80-2	80A 2pole C 10kA Circuit Breaker	14849022	\$753.18	\$331.40
MDWH-C100-2	100A 2pole C 10kA Circuit Breaker	14849023	\$753.18	\$331.40
MDWH-C125-2	125A 2pole C 10kA Circuit Breaker	14849024	\$753.18	\$331.40
Three Pole - Curve C, Im = 5 to 10xIn				
MDWH-C2-3	2A 3pole C 10kA Circuit Breaker	13441576	\$183.88	\$80.91
MDWH-C4-3	4A 3pole C 10kA Circuit Breaker	13441577	\$183.88	\$80.91
MDWH-C6-3	6A 3pole C 10kA Circuit Breaker	11422664	\$168.01	\$73.92
MDWH-C10-3	10A 3pole C 10kA Circuit Breaker	11422688	\$168.01	\$73.92
MDWH-C16-3	16A 3pole C 10kA Circuit Breaker	11422692	\$168.01	\$73.92
MDWH-C20-3	20A 3pole C 10kA Circuit Breaker	11422696	\$168.01	\$73.92
MDWH-C25-3	25A 3pole C 10kA Circuit Breaker	11422710	\$168.01	\$73.92
MDWH-C32-3	32A 3pole C 10kA Circuit Breaker	11422715	\$168.01	\$73.92
MDWH-C40-3	40A 3pole C 10kA Circuit Breaker	11422720	\$186.49	\$82.06
MDWH-C50-3	50A 3pole C 10kA Circuit Breaker	11422725	\$259.47	\$114.17
MDWH-C63-3	63A 3pole C 10kA Circuit Breaker	11422729	\$259.47	\$114.17
MDWH-C80-3	80A 3pole C 10kA Circuit Breaker	14849025	\$1,136.92	\$500.24
MDWH-C100-3	100A 3pole C 10kA Circuit Breaker	14849026	\$1,136.92	\$500.24
MDWH-C125-3	125A 3pole C 10kA Circuit Breaker	14849027	\$1,136.92	\$500.24

Contractor



High Capacity Miniature 10kA Circuit Breakers

Conform IEC 60898



Item number	Description	SAP number	Trade Price	Contractor Price
Single Pole - Curve D, Im = 3 to 5xIn				
MDWH-D2	2A 1pole D 10kA Circuit Breaker	14110145	\$92.00	\$40.48
MDWH-D4	4A 1pole D 10kA Circuit Breaker	14110146	\$92.00	\$40.48
MDWH-D6	6A 1pole D 10kA Circuit Breaker	14110022	\$92.00	\$40.48
MDWH-D10	10A 1pole D 10kA Circuit Breaker	14110082	\$92.00	\$40.48
MDWH-D16	16A 1pole D 10kA Circuit Breaker	14110086	\$92.00	\$40.48
MDWH-D20	20A 1pole D 10kA Circuit Breaker	14110102	\$92.00	\$40.48
MDWH-D25	25A 1pole D 10kA Circuit Breaker	14110107	\$92.00	\$40.48
MDWH-D32	32A 1pole D 10kA Circuit Breaker	14110114	\$92.00	\$40.48
MDWH-D40	40A 1pole D 10kA Circuit Breaker	14110122	\$92.00	\$40.48
MDWH-D50	50A 1pole D 10kA Circuit Breaker	14110127	\$118.85	\$52.29
MDWH-D63	63A 1pole D 10kA Circuit Breaker	14110141	\$118.85	\$52.29
MDWH-D80	80A 1pole D 10kA Circuit Breaker	14849032	\$362.46	\$159.48
MDWH-D100	100A 1pole D 10kA Circuit Breaker	14849033	\$362.46	\$159.48
MDWH-D125	125A 1pole D 10kA Circuit Breaker	14849034	\$362.46	\$159.48
Two Pole - Curve D, Im = 3 to 5xIn				
MDWH-D2-2	2A 2pole D 10kA Circuit Breaker	14110147	\$199.71	\$87.87
MDWH-D4-2	4A 2pole D 10kA Circuit Breaker	14110168	\$199.71	\$87.87
MDWH-D6-2	6A 2pole D 10kA Circuit Breaker	14110023	\$199.71	\$87.87
MDWH-D10-2	10A 2pole D 10kA Circuit Breaker	14110083	\$199.71	\$87.87
MDWH-D16-2	16A 2pole D 10kA Circuit Breaker	14110098	\$199.71	\$87.87
MDWH-D20-2	20A 2pole D 10kA Circuit Breaker	14110103	\$199.71	\$87.87
MDWH-D25-2	25A 2pole D 10kA Circuit Breaker	14110108	\$199.71	\$87.87
MDWH-D32-2	32A 2pole D 10kA Circuit Breaker	14110116	\$199.71	\$87.87
MDWH-D40-2	40A 2pole D 10kA Circuit Breaker	14110124	\$222.01	\$97.68
MDWH-D50-2	50A 2pole D 10kA Circuit Breaker	14110138	\$276.75	\$121.77
MDWH-D63-2	63A 2pole D 10kA Circuit Breaker	14110142	\$276.75	\$121.77
MDWH-D80-2	80A 2pole D 10kA Circuit Breaker	14849036	\$477.91	\$210.28
MDWH-D100-2	100A 2pole D 10kA Circuit Breaker	14849037	\$477.91	\$210.28
MDWH-D125-2	125A 2pole D 10kA Circuit Breaker	14849118	\$477.91	\$210.28
Three Pole - Curve D, Im = 3 to 5xIn				
MDWH-D2-3	2A 3pole D 10kA Circuit Breaker	14110169	\$230.00	\$101.20
MDWH-D4-3	4A 3pole D 10kA Circuit Breaker	14110170	\$230.00	\$101.20
MDWH-D6-3	6A 3pole D 10kA Circuit Breaker	14110079	\$230.00	\$101.20
MDWH-D10-3	10A 3pole D 10kA Circuit Breaker	14110084	\$230.00	\$101.20
MDWH-D16-3	16A 3pole D 10kA Circuit Breaker	14110099	\$230.00	\$101.20
MDWH-D20-3	20A 3pole D 10kA Circuit Breaker	14110104	\$230.00	\$101.20
MDWH-D25-3	25A 3pole D 10kA Circuit Breaker	14110110	\$230.00	\$101.20
MDWH-D32-3	32A 3pole D 10kA Circuit Breaker	14110118	\$230.00	\$101.20
MDWH-D40-3	40A 3pole D 10kA Circuit Breaker	14110125	\$283.41	\$124.70
MDWH-D50-3	50A 3pole D 10kA Circuit Breaker	14110139	\$283.41	\$124.70
MDWH-D63-3	63A 3pole D 10kA Circuit Breaker	14110143	\$283.41	\$124.70
MDWH-D80-3	80A 3pole D 10kA Circuit Breaker	14849121	\$722.10	\$317.72
MDWH-D100-3	100A 3pole D 10kA Circuit Breaker	14849122	\$722.10	\$317.72
MDWH-D125-3	125A 3pole D 10kA Circuit Breaker	14849123	\$722.10	\$317.72

Contractor



Residual Current Circuit Breakers

Conform IEC 61008-1

	Item number	Description	SAP number	Trade Price	Contractor Price		
	Two Pole - Class A, Im = 500A or 10x In (whichever is greater) Idm 30mA or 300mA						
		RDWH-A-30-25-2-D24	Residual Current CB Class A 25A/30mA 2pole 230V	14763945	\$255.07	\$112.23	
		RDWH-A-30-40-2-D24	Residual Current CB Class A 40A/30mA 2pole 230V	14763946	\$255.07	\$112.23	
		RDWH-A-30-63-2-D24	Residual Current CB Class A 63A/30mA 2pole 230V	14763947	\$256.49	\$112.86	
		RDWH-A-300-25-2-D24	Residual Current CB Class A 25A/300mA 2pole 230V	14763972	\$255.07	\$112.23	
		RDWH-A-300-40-2-D24	Residual Current CB Class A 40A/300mA 2pole 230V	14763973	\$255.07	\$112.23	
		RDWH-A-300-63-2-D24	Residual Current CB Class A 63A/300mA 2pole 230V	14763974	\$256.49	\$112.86	
		Four Pole - Class A, Im = 500A or 10x In (whichever is greater) Idm 30mA or 300mA					
			RDWH-A-30-25-4-D34	Residual Current CB Class A 25A/30mA 4pole 400V	14763996	\$394.14	\$173.42
			RDWH-A-30-40-4-D34	Residual Current CB Class A 40A/30mA 4pole 400V	14763997	\$394.14	\$173.42
		RDWH-A-30-63-4-D34	Residual Current CB Class A 63A/30mA 4pole 400V	14764009	\$412.58	\$181.54	
		RDWH-A-300-25-4-D34	Residual Current CB Class A 25A/300mA 4pole 400V	14764043	\$394.14	\$173.42	
		RDWH-A-300-40-4-D34	Residual Current CB Class A 40A/300mA 4pole 400V	14764044	\$394.14	\$173.42	
	RDWH-A-300-63-4-D34	Residual Current CB Class A 63A/300mA 4pole 400V	14764045	\$412.58	\$181.54		
	Accessory (the AD-1 is mandatory when using any accessory)						
	BC-1 MDA	RDWx Auxiliary contact block SPDT (NO-C-NC) (add AD-1)	14641021	\$45.13	\$19.86		
	AL-1 MDA	RDWx Alarm contact block SPDT (NO-C-NC) (add AD-1)	14641022	\$51.59	\$22.70		
	BD E03 MDA	RDWx Shunt Trip 24-48V AC/DC (add AD-1)	14641027	\$128.96	\$56.74		
	BD E69 MDA	RDWx Shunt Trip 100-415V AC/DC (add AD-1)	14641118	\$128.96	\$56.74		
	BS E26 MDA	RDWx Undervoltage release coil 24V AC/DC (add AD-1)	14641119	\$238.56	\$104.97		
	BS E27 MDA	RDWx Undervoltage release coil 48V AC/DC (add AD-1)	14641120	\$238.56	\$104.97		
	BS E68 MDA	RDWx Undervoltage release coil 125V AC/DC (add AD-1)	14641121	\$238.56	\$104.97		
	BS D13 MDA	RDWx Undervoltage release coil 110V AC (add AD-1)	14641122	\$238.56	\$104.97		
	BS D24 MDA	RDWx Undervoltage release coil 230V AC (add AD-1)	14641123	\$238.56	\$104.97		
Contractor	AD-1	RDWx Accessory adapter. Required for any accessory.	14845987	\$51.59	\$22.70		



Miniature Disconnecter Switch

Conform IEC 60898

	Item number	Description	SAP number	Trade Price	Contractor Price
	SIW-40-2	40A 2pole Disconnecter Switch	10075767	\$52.30	\$23.01
	SIW-63-2	63A 2pole Disconnecter Switch	10075770	\$62.27	\$27.40
	SIW-80-2	80A 2pole Disconnecter Switch	10075773	\$87.62	\$38.55
	SIW-100-2	100A 2pole Disconnecter Switch	10075776	\$112.96	\$49.70
	SIW-40-3	40A 3pole Disconnecter Switch	10075768	\$81.20	\$35.73
	SIW-63-3	63A 3pole Disconnecter Switch	10075771	\$97.39	\$42.85
	SIW-80-3	80A 3pole Disconnecter Switch	10075774	\$128.82	\$56.68
	SIW-100-3	100A 3pole Disconnecter Switch	10075777	\$150.69	\$66.30
	SIW-40-4	40A 4pole Disconnecter Switch	10075769	\$153.82	\$67.68
	SIW-63-4	63A 4pole Disconnecter Switch	10075772	\$163.79	\$72.07
	SIW-80-4	80A 4pole Disconnecter Switch	10075775	\$192.43	\$84.67
	SIW-100-4	100A 4pole Disconnecter Switch	10075778	\$221.08	\$97.28



High Capacity Miniature 10kA Circuit Breakers

Conform IEC 60898

Item number	Description	SAP number	Trade Price	Contractor Price
MDWH-BC1	Auxiliary Contact for MDWH 6 - 63A	11882693	\$63.00	\$27.72
MDWHAL-1	Alarm Contact for MDWH 6 - 63 A	11894565	\$63.54	\$27.96
MDWHAX-1	Auxiliary Contact + Alarm Contact for MDWH 6 - 63 A	11894566	\$97.28	\$42.80
BSE25MDWH6-63A	Undervoltage Release 12Vac/dc for MDWH 6 - 63A	11894563	\$201.65	\$88.73
BSE31MDWH6-63A	Undervoltage Release 220Vac/dc for MDWH 6 - 63A	11894564	\$201.65	\$88.73
MDW-PLW63	Padlock Device for MDW 2 - 63A	11373980	\$13.21	\$5.81
BR112	Bus bar for 12x1pole MDW 2 - 63 A	11402519	\$16.05	\$7.06
BR154	Bus bar for 54x1pole MDW 2 - 63 A	11156854	\$66.30	\$29.17
BR34	Bus bar for 4x3pole MDW 2 - 63 A	11402457	\$49.26	\$21.67
BR318	Bus bar for 18x3pole MDW 2 - 63 A	11156857	\$193.75	\$85.25
AL-BR	Connector for MDW 2 - 63 A	11156853	\$10.17	\$4.47
IS1	Insulation Side of single-pole bus bar BR1	11402911	\$385.07	\$169.43
IS3	Insulation Side of three-pole bus bar BR3	11402909	\$405.89	\$178.59
IPB	Bus bar pin isolator for BR1 - 3	11863723	\$134.43	\$59.15

FNH FUSES



- aR Class High Speed Fuses,
NH Blade Contact Type 100 kA / 690 V ac
Available in models:

- FNH00 - size 00
- FNH000 - size 000
- FNH1 - size 1
- FNH2 - size 2
- FNH3 - size 3



- NH Flush-End 200 kA / 690 V ac
Available in models:

- FNH3FEM
- FNH23FEA (2 fuses in parallel)



Short-Circuit Protection in AC Circuits



Current Limiter



Accessories available on request







High Speed Fuses NH

Item number	Description	SAP number	Trade Price	Contractor Price	
FNH000-20K-A	20A Semiconductor Fuse NH000	13735555	\$89.53	\$39.39	
FNH000-25K-A	25A Semiconductor Fuse NH000	13735656	\$89.53	\$39.39	
FNH000-35K-A	35A Semiconductor Fuse NH000	13737105	\$89.53	\$39.39	
FNH000-40K-A	40A Semiconductor Fuse NH000	13737107	\$89.53	\$39.39	
FNH00-20K-A	20A Semiconductor Fuse NH00	10687494	\$89.53	\$39.39	
FNH00-25K-A	25A Semiconductor Fuse NH00	10701722	\$89.53	\$39.39	
FNH00-35K-A	35A Semiconductor Fuse NH00	10701721	\$89.53	\$39.39	
FNH00-40K-A	40A Semiconductor Fuse NH00	10702117	\$89.53	\$39.39	
FNH00-50K-A	50A Semiconductor Fuse NH00	10701718	\$89.53	\$39.39	
FNH00-63K-A	63A Semiconductor Fuse NH00	10705764	\$119.19	\$52.44	
FNH00-80K-A	80A Semiconductor Fuse NH00	10705995	\$119.19	\$52.44	
FNH00-100K-A	100A Semiconductor Fuse NH00	10707110	\$119.19	\$52.44	
FNH00-125K-A	125A Semiconductor Fuse NH00	10707231	\$119.19	\$52.44	
FNH00-160K-A	160A Semiconductor Fuse NH00	10701724	\$136.64	\$60.12	
FNH00-200K-A	200A Semiconductor Fuse NH00	10710732	\$136.64	\$60.12	
FNH00-250K-A	250A Semiconductor Fuse NH00	10711445	\$136.64	\$60.12	
FNH1-63K-A	63A Semiconductor Fuse NH1	10806688	\$240.47	\$105.81	
FNH1-80K-A	80A Semiconductor Fuse NH1	10807549	\$240.47	\$105.81	
FNH1-100K-A	100A Semiconductor Fuse NH1	10807553	\$240.47	\$105.81	
FNH1-125K-A	125A Semiconductor Fuse NH1	10807554	\$240.47	\$105.81	
FNH1-160K-A	160A Semiconductor Fuse NH1	10808545	\$269.56	\$118.61	
FNH1-200K-A	200A Semiconductor Fuse NH1	10809133	\$269.56	\$118.61	
FNH1-250K-A	250A Semiconductor Fuse NH1	10809489	\$269.56	\$118.61	
FNH1-315K-A	315A Semiconductor Fuse NH1	10809575	\$269.56	\$118.61	
FNH1-350K-A	350A Semiconductor Fuse NH1	10814896	\$321.78	\$141.58	
FNH1-400K-A	400A Semiconductor Fuse NH1	10815073	\$321.78	\$141.58	
FNH2-250K-A	250A Semiconductor Fuse NH2	10823581	\$403.27	\$177.44	
FNH2-315K-A	315A Semiconductor Fuse NH2	10823936	\$403.27	\$177.44	
FNH2-350K-A	350A Semiconductor Fuse NH2	10823996	\$524.47	\$230.77	
FNH2-400K-A	400A Semiconductor Fuse NH2	10824053	\$524.47	\$230.77	
FNH2-450K-A	450A Semiconductor Fuse NH2	10824055	\$524.47	\$230.77	
FNH2-500K-A	500A Semiconductor Fuse NH2	10824109	\$559.69	\$246.26	
FNH2-630K-A	630A Semiconductor Fuse NH2	10824110	\$559.69	\$246.26	
FNH2-710K-A	710A Semiconductor Fuse NH2	11393547	\$559.69	\$246.26	
FNH3-400K-A	400A Semiconductor Fuse NH3	10831217	\$583.32	\$256.66	
FNH3-450K-A	450A Semiconductor Fuse NH3	10832962	\$583.32	\$256.66	
FNH3-500K-A	500A Semiconductor Fuse NH3	10833056	\$583.32	\$256.66	
FNH3-630K-A	630A Semiconductor Fuse NH3	10833101	\$638.90	\$281.12	
FNH3-710K-A	710A Semiconductor Fuse NH3	10833591	\$638.90	\$281.12	
FNH3-800K-A	800A Semiconductor Fuse NH3	10833726	\$776.17	\$341.51	
FNH3-900K-A	900A Semiconductor Fuse NH3	11393564	\$776.17	\$341.51	
FNH3-1000K-A	1000A Semiconductor Fuse NH3	11393565	\$776.17	\$341.51	
Contractor	FNH3-1000K-A	1000A Semiconductor Fuse NH3	11393565	\$776.17	\$341.51







Electrical Circuit Protection Fuse - gL/gG NH

	Item number	Description	SAP number	Trade Price	Contractor Price
	FNH000-4U	4A gL/gG Fuse NH000	10891504	\$85.93	\$37.81
	FNH000-6U	6A gL/gG Fuse NH000	10891107	\$85.93	\$37.81
	FNH000-10U	10A gL/gG Fuse NH000	10890978	\$85.93	\$37.81
	FNH000-16U	16A gL/gG Fuse NH000	10890945	\$85.93	\$37.81
	FNH000-20U	20A gL/gG Fuse NH000	10889723	\$85.93	\$37.81
	FNH000-25U	25A gL/gG Fuse NH000	10889565	\$85.93	\$37.81
	FNH000-35U	35A gL/gG Fuse NH000	10889349	\$85.93	\$37.81
	FNH000-50U	50A gL/gG Fuse NH000	10888901	\$85.93	\$37.81
	FNH000-63U	63A gL/gG Fuse NH000	10888698	\$85.93	\$37.81
	FNH000-80U	80A gL/gG Fuse NH000	10887824	\$100.71	\$44.31
	FNH00-4U	4A gL/gG Fuse NH00	10185934	\$91.29	\$40.17
	FNH00-6U	6A gL/gG Fuse NH00	10045369	\$91.29	\$40.17
	FNH00-10U	10A gL/gG Fuse NH00	10409880	\$91.29	\$40.17
	FNH00-16U	16A gL/gG Fuse NH00	10409881	\$91.29	\$40.17
	FNH00-20U	20A gL/gG Fuse NH00	10409882	\$91.29	\$40.17
	FNH00-25U	25A gL/gG Fuse NH00	10409883	\$91.29	\$40.17
	FNH00-35U	35A gL/gG Fuse NH00	10409884	\$91.29	\$40.17
	FNH00-50U	50A gL/gG Fuse NH00	10409885	\$91.29	\$40.17
	FNH00-63U	63A gL/gG Fuse NH00	10409886	\$91.29	\$40.17
	FNH00-80U	80A gL/gG Fuse NH00	10409887	\$100.71	\$44.31
	FNH00-100U	100A gL/gG Fuse NH00	10409888	\$100.71	\$44.31
	FNH00-125U	125A gL/gG Fuse NH00	10409889	\$100.71	\$44.31
	FNH00-160U	160A gL/gG Fuse NH00	10045370	\$110.10	\$48.44
	FNH1-50U	50A gL/gG Fuse NH1	10045371	\$204.08	\$89.80
	FNH1-63U	63A gL/gG Fuse NH1	10185935	\$204.08	\$89.80
	FNH1-80U	80A gL/gG Fuse NH1	10409890	\$204.08	\$89.80
	FNH1-100U	100A gL/gG Fuse NH1	10409891	\$204.08	\$89.80
	FNH1-125U	125A gL/gG Fuse NH1	10185936	\$216.16	\$95.11
	FNH1-160U	160A gL/gG Fuse NH1	10409892	\$216.16	\$95.11
	FNH1-200U	200A gL/gG Fuse NH1	10409893	\$256.43	\$112.83
	FNH1-224U	224A gL/gG Fuse NH1	10409894	\$256.43	\$112.83
	FNH1-250U	250A gL/gG Fuse NH1	10045372	\$256.43	\$112.83
	FNH2-125U	125A gL/gG Fuse NH2	10045373	\$299.39	\$131.73
	FNH2-160U	160A gL/gG Fuse NH2	10409895	\$299.39	\$131.73
	FNH2-200U	200A gL/gG Fuse NH2	10045374	\$299.39	\$131.73
	FNH2-224U	224A gL/gG Fuse NH2	10045375	\$299.39	\$131.73
	FNH2-250U	250A gL/gG Fuse NH2	10409896	\$299.39	\$131.73
	FNH2-300U	300A gL/gG Fuse NH2	10409897	\$362.50	\$159.50
	FNH2-315U	315A gL/gG Fuse NH2	10185937	\$362.50	\$159.50
	FNH2-355U	355A gL/gG Fuse NH2	10409898	\$362.50	\$159.50
	FNH2-400U	400A gL/gG Fuse NH2	10045376	\$451.11	\$198.49
Contractor	FNH3-315U	315A gL/gG Fuse NH3	10409899	\$451.11	\$198.49
	FNH3-355U	355A gL/gG Fuse NH3	10409900	\$451.11	\$198.49
	FNH3-400U	400A gL/gG Fuse NH3	10409901	\$451.11	\$198.49
	FNH3-425U	325A gL/gG Fuse NH3	10409902	\$451.11	\$198.49
	FNH3-500U	500A gL/gG Fuse NH3	10409903	\$451.11	\$198.49
	FNH3-630U	630A gL/gG Fuse NH3	10045377	\$551.82	\$242.80



High Speed Fuses NH Accessories

	Item number	Description	SAP number	Trade Price	Contractor Price
	PSFNH	Fuse Extractor Handle "NH" Blade Contact	10185944	\$350.76	\$154.33
	BNH00-160	3 units of Fuse Base "NH" Blade Contact 00 (4-160A)	10409904	\$54.81	\$24.12
	BNH1-250	3 units of Fuse Base "NH" Blade Contact 1 (50-250A)	10409905	\$205.50	\$90.42
	BNH2-400	3 units of Fuse Base "NH" Blade Contact 2 (125-400A)	10185938	\$319.66	\$140.65
	BNH3-630	3 units of Fuse Base "NH" Blade Contact 3 (315-630A)	10185939	\$456.65	\$200.93
	PDNH00	2 units of Partition Walls for "NH" Blade Contact Fuses 00	10185940	\$32.06	\$14.11
	PDNH1	4 units of Partition Walls for "NH" Blade Contact Fuses 1	10185941	\$119.01	\$52.36
	PDNH2	4 units of Partition Walls for "NH" Blade Contact Fuses 2	10185942	\$129.83	\$57.13
	PDNH3	4 units of Partition Walls for "NH" Blade Contact Fuses 3	10185943	\$151.61	\$66.71
	FSW 100-3 H	Fuse-Switch-Disconnectors FSW 000	11884107	\$330.16	\$145.27
	FSW 160-3 H	Fuse-Switch-Disconnectors FSW 00	11884182	\$363.26	\$159.83
	FSW 250-3 H	Fuse-Switch-Disconnectors FSW 1	11884179	\$1,053.49	\$463.54
	FSW 400-3 H	Fuse-Switch-Disconnectors FSW 2	11884180	\$1,580.00	\$695.20
	FSW 630-3 H	Fuse-Switch-Disconnectors FSW 3	11884181	\$1,896.22	\$834.34
Contractor	FSW TS-100	Terminal Cover FSW100	11884546	\$14.16	\$6.23
	FSW TS-160	Terminal Cover FSW160	11884568	\$19.41	\$8.54
	FSW TS-250	Terminal Cover FSW250	11997752	\$41.10	\$18.08
	FSW TS-400	Terminal Cover FSW400	11884547	\$64.85	\$28.53



High Speed Fuses NH Flush-End Contact

	Item number	Description	SAP number	Trade Price	Contractor Price
	FNH3FEM-450Y-A	450A Semiconductor Fuse FNH3FEM Flush End Type	12644962	\$677.99	\$298.32
	FNH3FEM-500Y-A	500A Semiconductor Fuse FNH3FEM Flush End Type	12645317	\$677.99	\$298.32
	FNH3FEM-550Y-A	550A Semiconductor Fuse FNH3FEM Flush End Type	12660187	\$677.99	\$298.32
	FNH3FEM-630Y-A	630A Semiconductor Fuse FNH3FEM Flush End Type	12660583	\$708.81	\$311.88
	FNH3FEM-700Y-A	700A Semiconductor Fuse FNH3FEM Flush End Type	12660657	\$708.81	\$311.88
	FNH3FEM-800Y-A	800A Semiconductor Fuse FNH3FEM Flush End Type	12661660	\$708.81	\$311.88
	FNH3FEM-900Y-A	900A Semiconductor Fuse FNH3FEM Flush End Type	12661662	\$850.62	\$374.27
	FNH3FEM-1000Y-A	1000A Semiconductor Fuse FNH3FEM Flush End Type	12661663	\$850.62	\$374.27
	FNH3FEM-1100Y-A	1100A Semiconductor Fuse FNH3FEM Flush End Type	12661664	\$850.62	\$374.27
	FNH3FEM-1250Y-A	1250A Semiconductor Fuse FNH3FEM Flush End Type	12661665	\$1,201.95	\$528.86
	FNH3FEM-1400Y-A	1400A Semiconductor Fuse FNH3FEM Flush End Type	12661666	\$1,201.95	\$528.86
	FNH23FEA-1000Y-A*	1000A Semiconductor Fuse FNH3FEM Flush End Type	12644745	\$1,966.09	\$865.08
	FNH23FEA-1250Y-A*	1250A Semiconductor Fuse FNH3FEM Flush End Type	12661667	\$2,095.84	\$922.17
	FNH23FEA-1400Y-A*	1400A Semiconductor Fuse FNH3FEM Flush End Type	12661688	\$1,940.27	\$853.72
	FNH23FEA-1600Y-A*	1600A Semiconductor Fuse FNH3FEM Flush End Type	12661689	\$2,042.21	\$898.57
	FNH23FEA-1800Y-A*	1800A Semiconductor Fuse FNH3FEM Flush End Type	12661690	\$2,140.83	\$941.97
	FNH23FEA-2000Y-A*	2000A Semiconductor Fuse FNH3FEM Flush End Type	12661692	\$2,211.73	\$973.16
	Accessories				
Contractor	MS11FE	Actuation Switch for FNH3FEM/FNH23FEA (1NO+NC)	12626734	\$136.43	\$60.03

(*) Two flush end fuses, size 3, assembled in parallel

MSW ISOLATOR SWITCHES



Modern and compact design, demanding little installation space



Complete accessory line



Terminals with IP20 degree of protection



IP65 protection rating handles that allow the use of up to three padlocks and door interlocking





ON/OFF indication on the handle









Two mounting options for the switch-disconnectors meeting the need of different applications



MSW Isolator Switch

	Item number	Description	SAP number	Trade Price	Contractor Price	
	MSW12P-3	3 pole Door Mount isolator switch 16A (excl.handle)	12258305	\$102.03	\$72.44	
	MSW16P-3	3 pole Door Mount isolator switch 20A (excl.handle)	12258306	\$112.79	\$80.08	
	MSW20P-3	3 pole Door Mount isolator switch 25A (excl.handle)	12258307	\$118.15	\$83.89	
	MSW25P-3	3 pole Door Mount isolator switch 32A (excl.handle)	11898714	\$126.50	\$89.82	
	MSW40P-3	3 pole Door Mount isolator switch 40A (excl.handle)	11898883	\$145.97	\$103.64	
	MSW63P-3	3 pole Door Mount isolator switch 63A (excl.handle)	11898884	\$194.90	\$138.38	
	MSW80P-3	3 pole Door Mount isolator switch 80A (excl.handle)	11898885	\$235.25	\$167.03	
	MSW100P-3	3 pole Door Mount isolator switch 100A (excl.handle)	11898887	\$503.47	\$357.46	
		MSW12B-3	3 pole Base Mount isolator switch 16A (excl.handle)	12258440	\$93.98	\$66.73
		MSW16B-3	3 pole Base Mount isolator switch 20A (excl.handle)	12258441	\$98.01	\$69.59
MSW20B-3		3 pole Base Mount isolator switch 25A (excl.handle)	12258442	\$103.37	\$73.39	
MSW25B-3		3 pole Base Mount isolator switch 32A (excl.handle)	11898940	\$107.94	\$76.64	
MSW40B-3		3 pole Base Mount isolator switch 40A (excl.handle)	11898946	\$127.42	\$90.47	
MSW63B-3		3 pole Base Mount isolator switch 63A (excl.handle)	11898924	\$194.90	\$138.38	
MSW80B-3		3 pole Base Mount isolator switch 80A (excl.handle)	11898926	\$216.70	\$153.86	
MSW125B-3		3 pole Base Mount isolator switch 125A (excl.handle)	11898939	\$495.96	\$352.13	
MSW160B-3		3 pole Base Mount isolator switch 160A (excl.handle)	11898927	\$670.93	\$476.36	

Accessories

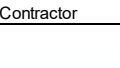
	MSWH20P	Rotary handle red/yellow for MSW 12-20 P	12258462	\$50.72	\$36.01
	MSWH40P	Rotary handle red/yellow for MSW 25/40 P (being gradually superseded)	11899507	\$50.72	\$36.01
	MSWH40P-N-R	Rotary handle red/yellow for MSW 25/40 P	15481531	\$69.77	\$49.54
	MSWH100P	Rotary handle red/yellow for MSW 63/80/100 P	11899509	\$50.72	\$36.01
	MSWH40P-B	Rotary handle black/grey for MSW 25/40 P (being gradually superseded)	12746822	\$50.72	\$36.01
	MSWH40P-N-B	Rotary handle black/grey for MSW 25/40 P	15481530	\$69.77	\$49.54
	MSWH100P-B	Rotary handle black/grey for MSW 63/80/100 P	12746825	\$50.72	\$36.01
	MSWAP25-P-1NA	Neutral Pole contact for MSW25 P (NO early make)	12727286	\$57.96	\$41.15
	MSWAP40-P-1NA	Neutral Pole contact for MSW40 P (NO early make)	12727287	\$100.97	\$71.69
	MSWAP63-P-1NA	Neutral Pole contact for MSW63 P (NO early make)	12727300	\$100.97	\$71.69
MSWAP80-P-1NA	Neutral Pole contact for MSW80 P (NO early make)	12727301	\$204.74	\$145.37	
	MSWAC-40P1NC	Auxiliary Contact NC for MSW25/40 P	11899468	\$52.53	\$37.30
	MSWAC-40P1NO	Auxiliary Contact NO for MSW25/40 P	11899469	\$52.53	\$37.30
	MSWAC-80P1NC	Auxiliary Contact NC for MSW63/80 P	11899472	\$52.53	\$37.30
	MSWAC-80P1NO	Auxiliary Contact NO for MSW63/80 P	11899476	\$52.53	\$37.30
	MSWTS-40P	Terminal Cover for MSW25/40	11899502	\$21.01	\$14.92
	MSWTS-100P	Terminal Cover for MSW100	11899505	\$42.03	\$29.84
	MSWH20B	Rotary handle red/yellow for MSW 12-20 B	12258463	\$53.44	\$37.94
	MSWH40B	Rotary handle red/yellow for MSW 25/40 B	11899512	\$67.39	\$47.85
	MSWH80B	Rotary handle red/yellow for MSW 63/80 B	11966588	\$67.39	\$47.85
	MSWH160B	Rotary handle red/yellow for MSW 125/160 B	11899515	\$85.29	\$60.56
	MSWH40B-B	Rotary handle black/grey for MSW 25/40 B	12746823	\$67.39	\$47.85
	MSWH80B-B	Rotary handle black/grey for MSW 63/80 B	12746824	\$67.39	\$47.85
MSWH160B-B	Rotary handle black/grey for MSW 125/160 B	12746826	\$85.29	\$60.56	
	MSWHS185-40	Shaft 185mm for MSW25/40 B	12030688	\$51.69	\$36.70
	MSWHS300-40	Shaft 300mm for MSW25/40 B	12030689	\$57.07	\$40.52
	MSWHS185-160	Shaft 185mm for MSW63/80/125 B	12030690	\$64.05	\$45.48
	MSWHS300-160	Shaft 300mm for MSW63/80/125 B	12030691	\$69.41	\$49.28
	MSWAP25-B-1NA	Neutral Pole contact for MSW25 B (NO early make)	12727284	\$57.96	\$41.15
	MSWAP40-B-1NA	Neutral Pole contact for MSW40 B (NO early make)	12727285	\$100.97	\$71.69
	MSWAP63-B-1NA	Neutral Pole contact for MSW63 B (NO early make)	12727298	\$100.97	\$71.69
	MSWAP80-B-1NA	Neutral Pole contact for MSW80 B (NO early make)	12727299	\$204.74	\$145.37
	MSWAP160-B-1NA	Neutral Pole contact for MSW125/MSW160 B (NO early make)	13052847	\$231.60	\$164.44
		MSWAC-40B1NC	Auxiliary Contact NC for MSW25/40 B	11899456	\$56.38
MSWAC-40B1NO		Auxiliary Contact NO for MSW25/40 B	11899457	\$56.38	\$40.03
MSWAC-80B1NC		Auxiliary Contact NC for MSW63/80 B	11899470	\$56.38	\$40.03
MSWAC-80B1NO		Auxiliary Contact NO for MSW63/80 B	11899471	\$56.38	\$40.03
MSWAC160-B-1NC		Auxiliary Contact NC for MSW125 B	13233894	\$134.60	\$95.57
MSWAC160-B-1NO		Auxiliary Contact NO for MSW125 B	13233893	\$134.60	\$95.57
	MSWTS-40B	Terminal Cover for MSW25/40 B	11899501	\$22.52	\$15.99
	MSWTS-80B/P	Terminal Cover for MSW63/80 P/B	11899504	\$42.03	\$29.84
	MSWTS-160B	Terminal Cover for MSW125 B	13164789	\$114.41	\$81.23

Prices Exclude GST and are subject to change at any time Ref: V24

ACW MOULDED CASE CIRCUIT BREAKERS



Robustness and reliability



Guarantee of safety of the installation



Wide range of accessories to reduce downtime and to make installation easy



Suitable for different applications



Several types of tripping devices



High breaking capacity



Conceived with a modern and compact design, and available in five frames with currents ranging from 20 to 1,600 A, the ACW circuit breakers are divided into two lines with different short-circuit interrupting capacities



ACW H Line - Medium short-circuit interrupting capacity, also including $I_{cs} = 100\%$ in the entire line



Electrical Circuit Protection up to 1600A



ACW Moulded Case Circuit Breakers

	Item number	Description	SAP number	Trade Price	Contractor Price
	ACW100H-FMU20-3	20A ACW100 Circuit Breaker FMU	11111144	\$1,199.02	\$851.30
	ACW100H-FMU25-3	25A ACW100 Circuit Breaker FMU	11111170	\$1,199.02	\$851.30
	ACW100H-FMU32-3	32A ACW100 Circuit Breaker FMU	11111172	\$1,199.02	\$851.30
	ACW100H-FMU50-3	50A ACW100 Circuit Breaker FMU	11111174	\$1,199.02	\$851.30
	ACW100H-FMU63-3	63A ACW100 Circuit Breaker FMU	11111175	\$1,199.02	\$851.30
	ACW100H-FMU100-3	100A ACW100 Circuit Breaker FMU	11111177	\$1,199.02	\$851.30
	ACW160H-FMU125-3	125A ACW160 Circuit Breaker FMU	11111219	\$1,895.37	\$1,345.71
	ACW160H-FMU160-3	160A ACW160 Circuit Breaker FMU	11111221	\$2,043.21	\$1,450.68
	ACW250H-ATU200-3	200A ACW250 Circuit Breaker ATU	11111344	\$3,119.12	\$2,214.58
	ACW250H-ATU250-3	250A ACW250 Circuit Breaker ATU	11111342	\$3,660.21	\$2,598.75
	ACW400H-ETS400-3	400A ACW400 Circuit Breaker ETS	11111394	POA	POA
	ACW630H-ETS630-3	630A ACW630 Circuit Breaker ETS	11111408	POA	POA
	ACW800U-ETS800-3	800A ACW800 Circuit Breaker ETS	10583696	POA	POA
	ACW1600H-AG11000-3	1100A ACW1600 Circuit Breaker AG1	12733276	POA	POA
	ACW1600H-AG11250-3	1250A ACW1600 Circuit Breaker AG1	12733277	POA	POA
	Contractor	ACW1600H-AG11600-3	1600A ACW1600 Circuit Breaker AG1	12733328	POA

FMU – Adjustable Thermal and Fixed Magnetic
 ATU – Both Thermal and Magnetic Adjustable
 ETS – Electronic Adjustment
 AG1 – Adjustment via keypad



ACW Moulded Case Circuit Breakers Accessories

	Item number	Description	SAP number	Trade Price	Contractor Price
	PIACW100-160	Plug-In Kit for ACW100-160	11111776	\$1,501.06	\$1,065.75
	PIACW250	Plug-In Kit for ACW250	11111777	\$1,762.08	\$1,251.08
	PIACW400-630	Plug-In Kit for ACW400-630	11111841	\$3,230.51	\$2,293.66
	PIACW800	Plug-In Kit for ACW800	11111843	\$8,679.99	\$6,162.79
	BC-1 ACW100-800	Auxiliary Contact for ACW100-800 NO-C-NC (up to 3)	10583677	\$136.78	\$97.11
	BC-1 ACW1600	Auxiliary Contact for ACW1600 NO-C-NC (up to 3)	12733489	\$136.78	\$97.11
	AL-1 ACW100-800	Alarm Contact for ACW100-800 NO-C-NC (up to 3)	10583678	\$136.78	\$97.11
	AL-1 ACW1600	Alarm Contact for ACW1600 NO-C-NC	12733490	\$136.78	\$97.11
	BD E44 ACW100-800	Shunt Release for ACW100-800	10583680	\$311.55	\$221.20
	BD ACW1600 E12	Shunt Release for ACW1600	12733496	\$311.55	\$221.20
	BS ACW100-800 E44	Undervoltage Release for ACW100-800	10583660	\$439.32	\$311.92
	BS ACW1600 E12	Undervoltage Release for ACW1600	12733531	\$439.32	\$311.92
	AM ACW100-160 E36	Motor Operator for ACW100-160 100-240Vac/100-220Vdc	10583656	\$1,905.03	\$1,352.57
	AM ACW250 E46	Motor Operator for ACW160-250 230Vac/220Vdc	10583658	\$2,040.85	\$1,449.00
	AM ACW400-630 E46	Motor Operator for ACW400-630 230Vac/220Vdc	10583661	\$3,637.24	\$2,582.44
	AM ACW800 E46	Motor Operator for ACW800 230Vac/220Vdc	10583663	\$3,979.05	\$2,825.13
	BE-ACW100-160	Extension Bars or Terminal Tags for ACW100-160	10583665	\$56.33	\$39.99
	BE-ACW250	Extension Bars or Terminal Tags for ACW160-250	10583666	\$64.38	\$45.71
	BE-ACW400-630	Extension Bars or Terminal Tags for ACW400-630	10583667	\$245.57	\$174.35
	BE-ACW800	Extension Bars or Terminal Tags for ACW800	10583664	\$412.29	\$292.73
BE ACW1600	Extension Bars or Terminal Tags for ACW1600	12733549	\$535.50	\$380.21	
PC2 ACW100-160	Round Cable Terminal for ACW100-160	10583668	\$189.89	\$134.82	
PC2 ACW250	Round Cable Terminal for ACW160-250	10583669	\$228.19	\$162.01	
PC2 ACW400-630	Round Cable Terminal for ACW400-630	10583671	\$578.06	\$410.42	
PC2 ACW800	Round Cable Terminal for ACW800	10583672	\$1,076.47	\$764.29	
PC2 ACW1600	Round Cable Terminal for ACW1600	12733552	\$1,076.47	\$764.29	
CP ACW100-160	Terminal Cover ACW100-160	10583673	\$35.85	\$25.45	
CP ACW250	Terminal Cover ACW160-250	10583674	\$35.97	\$25.54	
CP ACW400-630	Terminal Cover ACW400-630	10583675	\$66.49	\$47.21	
CP ACW800	Terminal Cover ACW800	10583676	\$104.91	\$74.49	
CP ACW1600	Terminal Cover ACW1600	10583676	\$124.78	\$88.59	
TR ACW100-160	Padlocking Device for ACW100-160	11799916	\$343.57	\$243.93	
TR ACW250	Padlocking Device for ACW160-250	11799917	\$343.57	\$243.93	
TR ACW400-630	Padlocking Device for ACW400-630	11800018	\$375.78	\$266.80	
TR ACW800	Padlocking Device for ACW800	11800019	\$375.78	\$266.80	
TR ACW1600	Padlocking Device for ACW1600	12733548	\$375.78	\$266.80	
MRI ACW100-160	Internal Rotary Handle for ACW100-160	10583652	\$225.28	\$159.95	
MRI ACW250	Internal Rotary Handle for ACW160-250	10583653	\$249.55	\$177.18	
MRI ACW400-630	Internal Rotary Handle for ACW400-630	10583903	\$479.89	\$340.72	
MRI ACW800	Internal Rotary Handle for ACW800	10583904	\$566.01	\$401.87	
MRI ACW1600	Internal Rotary Handle for ACW1600	12733533	\$2,123.83	\$1,507.92	
TTF ACW100-160	Rear Connection Flat for ACW100-160	11591643	\$2,062.98	\$1,464.72	
TTR ACW100-160	Rear Connection Round for ACW100-160	11591644	\$1,625.84	\$1,154.35	
TTF ACW250	Rear Connection Flat for ACW160-250	11591645	\$2,254.70	\$1,600.84	
TTR ACW250	Rear Connection Round for ACW160-250	11591646	\$1,664.18	\$1,181.57	
TTF ACW400-630	Rear Connection Flat for ACW400-630	11591647	\$4,026.25	\$2,858.64	
TTF ACW800	Rear Connection Flat for ACW800	11591658	\$9,337.08	\$6,629.33	
FT ACW101-161 D88	Earth Leakage Protection Module for ACW100-160 50/60Hz 220-460Vac	11424574	\$2,446.42	\$1,736.96	
FT ACW250 D88	Earth Leakage Protection Module for ACW250 50/60Hz 220-460Vac	11424575	\$2,446.42	\$1,736.96	
FT ACW630 D88	Earth Leakage Protection Module for ACW630 50/60Hz 220-460Vac	11424598	\$3,830.69	\$2,719.79	
FT ACW800 D88	Earth Leakage Protection Module for ACW800 50/60Hz 220-460Vac	11424567	\$4,881.36	\$3,465.77	
MRXL-A-ACW160-R	Panel Door Operating 105mm Red Handle for ACW100-160 (490mm shaft)	13993849	\$506.15	\$359.37	
MRXL-A-ACW250-R	Panel Door Operating 105mm Red Handle for ACW250 (490mm shaft)	13993870	\$529.17	\$375.71	
MRXL-A-ACW630-R	Panel Door Operating 158mm Red Handle for ACW400-630 (490mm shaft)	13993928	\$747.73	\$530.89	
MRXL-A-ACW800-R	Panel Door Operating 158mm Red Handle for ACW800 (490mm shaft)	13993930	\$874.27	\$620.73	
MR469 ACW1600	Panel Door Operating Double 158mm Red Handle for ACW1600 (490mm shaft)	12733535	\$2,285.14	\$1,622.45	

Prices Exclude GST and are subject to change at any time Ref: V24

POWER FACTOR CORRECTION CAPACITORS



UCWT Power Factor Correction Capacitors

- Polypropylene Film with Self-Healing Effect
- Over Pressure self-disconnect system
- Flexible installation and connection
- “Box” type terminals for connection of power cables
- Discharge resistor included
- Allows connection of power cables separately from discharge resistors
- Grounding is assured by connection of capacitive unit fixing bolt with assembly plate
- PCB free



Power Factor Capacitors

UCWT - Three Phase Capacitor Unit 415V

Item number	Description	SAP number	Trade Price	Contractor Price
UCWT0.5V49L10	0.37kVAr 415V (0.42kVAr 440V) 3ph 3 x 2.3uF D Ø60xH156 PFC Cap.	10046013	\$173.21	\$91.80
UCWT0.5V48L10	0.44kVAr 415V (0.50kVAr 440V) 3ph 3 x 2.7uF D Ø60xH156 PFC Cap.	10072545	\$176.41	\$93.50
UCWT0.75V49L10	0.56kVAr 415V (0.63kVAr 440V) 3ph 3 x 3.4uF D Ø60xH156 PFC Cap.	10046014	\$180.18	\$95.50
UCWT0.75V48L10	0.67kVAr 415V (0.57kVAr 440V) 3ph 3 x 4.1uF D Ø60xH156 PFC Cap.	10072546	\$184.24	\$97.65
UCWT1V49L10	0.74kVAr 415V (0.83kVAr 440V) 3ph 3 x 4.6uF D Ø60xH156 PFC Cap.	10046015	\$187.58	\$99.42
UCWT1V48L10	0.89kVAr 415V (1kVAr 440V) 3ph 3 x 5.5uF D Ø60xH156 PFC Cap.	10072547	\$192.07	\$101.80
UCWT1.5V49L10	1.11kVAr 415V (1.25kVAr 440V) 3ph 3 x 6.9uF D Ø60xH156 PFC Cap.	10046016	\$201.38	\$106.73
UCWT1.5V48L10	1.33kVAr 415V (1.5kVAr 440V) 3ph 3 x 8.2uF D Ø60xH156 PFC Cap.	10046254	\$207.80	\$110.13
UCWT2V49L10	1.48kVAr 415V (1.67kVAr 440V) 3ph 3 x 9.1uF D Ø60xH156 PFC Cap.	10046017	\$216.26	\$114.62
UCWT2V48L10	1.78kVAr 415V (2kVAr 440V) 3ph 3 x 11uF D Ø60xH156 PFC Cap.	10072548	\$222.45	\$117.90
UCWT2.5V49L10	1.85kVAr 415V (2.08kVAr 440V) 3ph 3 x 11.4uF D Ø60xH156 PFC Cap.	10046018	\$230.50	\$122.17
UCWT3V49L10	2.22kVAr 415V (2.5kVAr 440V) 3ph 3 x 13.7uF D Ø60xH156 PFC Cap.	10046019	\$241.73	\$128.12
UCWT3V48L16	2.67kVAr 415V (3kVAr 440V) 3ph 3 x 16.4uF D Ø60xH211 PFC Cap.	10072549	\$250.93	\$132.99
UCWT5V49L16	3.71kVAr 415V (4.17kVAr 440V) 3ph 3 x 22.8uF D Ø60xH211 PFC Cap.	10046020	\$298.60	\$158.26
UCWT5V48L16	4.45kVAr 415V (5kVAr 440V) 3ph 3 x 27.4uF D Ø60xH211 PFC Cap.	10046258	\$320.32	\$169.77
UCWT7.5V49N20	5.56kVAr 415V (6.25kVAr 440V) 3ph 3 x 34.3uF E Ø75xH225 PFC Cap.	11314663	\$410.66	\$217.65
UCWT7.5V48N20	6.67kVAr 415V (7.5kVAr 440V) 3ph 3 x 41.1uF E Ø75xH225 PFC Cap.	11758619	\$511.30	\$270.99
UCWT10V49N20	7.41kVAr 415V (8.33kVAr 440V) 3ph 3 x 45.7uF E Ø75xH225 PFC Cap.	11758279	\$538.71	\$285.52
UCWT10V48N22	8.90kVAr 415V (10kVAr 440V) 3ph 3 x 54.8uF E Ø75xH285 PFC Cap.	11758624	\$552.14	\$292.63
UCWT12.5V49N22	9.27kVAr 415V (10.42kVAr 440V) 3ph 3 x 57.1uF E Ø75xH285 PFC Cap.	11314665	\$611.78	\$324.24
UCWT12.5V48N22	11.12kVAr 415V (12.5kVAr 440V) 3ph 3 x 68.5uF E Ø75xH285 PFC Cap.	11758675	\$627.00	\$332.31
UCWT15V49Q26	11.12kVAr 415V (12.5kVAr 440V) 3ph 3 x 68.5uF F Ø100xH230 PFC Cap.	11917005	\$741.36	\$392.92
UCWT17.5V49Q26	12.97kVAr 415V (14.58kVAr 440V) 3ph 3 x 79.9uF F Ø100xH230 PFC Cap.	11917006	\$909.03	\$481.79
UCWT15V48Q26	13.34kVAr 415V (15kVAr 440V) 3ph 3 x 82.2uF F Ø100xH230 PFC Cap.	11917040	\$745.07	\$394.89
UCWT20V49Q26	14.83kVAr 415V (16.67kVAr 440V) 3ph 3 x 91.3uF F Ø100xH230 PFC Cap.	11917007	\$860.44	\$456.03
UCWT17.5V48Q26	15.57kVAr 415V (17.5kVAr 440V) 3ph 3 x 95.9uF F Ø100xH230 PFC Cap.	11917041	\$913.52	\$484.17
UCWT22.5V49S26	16.68kVAr 415V (18.75kVAr 440V) 3ph 3 x 102.8uF F Ø116xH230 PFC Cap.	11917018	\$915.36	\$485.14
UCWT20V48S26	17.79kVAr 415V (20kVAr 440V) 3ph 3 x 109.6uF F Ø116xH230 PFC Cap.	11917043	\$970.08	\$514.14
UCWT25V49S26	18.53kVAr 415V (20.83kVAr 440V) 3ph 3 x 114.2uF F Ø116xH230 PFC Cap.	11917021	\$960.20	\$508.91
UCWT22.5V48S26	20.02kVAr 415V (22.5kVAr 440V) 3ph 3 x 123.3uF F Ø116xH230 PFC Cap.	11917045	\$1,026.02	\$543.79
UCWT25V48S26	22.24kVAr 415V (25kVAr 440V) 3ph 3 x 137uF F Ø116xH230 PFC Cap.	11917058	\$1,044.23	\$553.44
UCWT35V49S28	25.95kVAr 415V (29.17kVAr 440V) 3ph 3 x 159.8uF F Ø116xH290 PFC Cap.	12272780	\$1,097.50	\$581.68

CWBC AND CWMC CONTACTORS

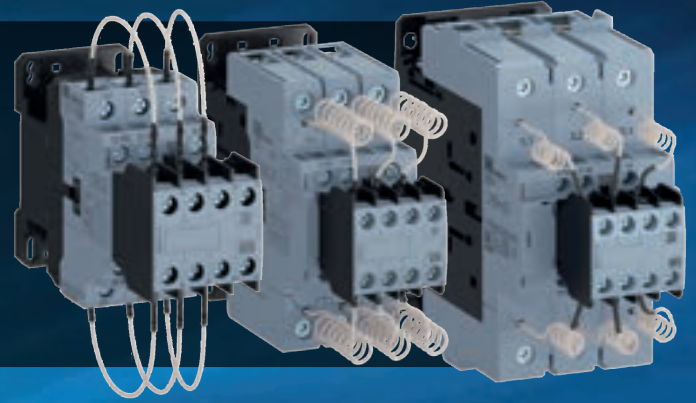

Easy Switching of Power Factor Correction Capacitors



Manages In-Rush Currents via Damping Resistors and Early Make Contact Block



Modular Design



Spare Coils and Accessories



Power Factor Correction Capacitors Switching Contactors

- Modular Design
For 35mm DIN rail or screw fixing
- Damping Resistors
Avoids high in-rush current
- Early Make Contact Block
Connects damping resistors and switches off after 5ms
- Auxiliary Contact
CWBC and CWMC allow the use of standard contact blocks,
the same used in CWB and CWM lines, being either NO or NC



Power Factor Capacitors Switching Contactors CWMC and CWBC lines

CWMC Contactors

Item number	Description	SAP number	Trade Price	Contractor Price
Contactors				
CWMC9-10-30X37	10kVAr 9A 3 pole Capacitor Switching Contactor CWMC (230-240V coil)	12713065	\$341.01	\$150.04
CWMC18-10-30X37	15kVAr 18A 3 pole Capacitor Switching Contactor CWMC (230-240V coil)	12615599	\$444.39	\$195.53
CWMC25-10-30X37	15kVAr 25A 3 pole Capacitor Switching Contactor CWMC (230-240V coil)	11486209	\$487.36	\$214.44
CWMC32-10-30X37	25kVAr 32A 3 pole Capacitor Switching Contactor CWMC (230-240V coil)	11486225	\$588.32	\$258.86
CWMC50-10-30X37	40kVAr 50A 3 pole Capacitor Switching Contactor CWMC (230-240V coil)	11486242	\$1,280.85	\$563.57
CWMC65-10-30X37	50kVAr 65A 3 pole Capacitor Switching Contactor CWMC (230-240V coil)	11486269	\$1,470.14	\$646.86
CWMC80-10-30X37	61kVAr 80A 3 pole Capacitor Switching Contactor CWMC (230-240V coil)	12380355	\$1,604.41	\$705.94
CWMC9-10-30X47	10kVAr 9A 3 pole Capacitor Switching Contactor CWMC (400-415V coil)	12713088	\$341.01	\$150.04
CWMC18-10-30X47	15kVAr 18A 3 pole Capacitor Switching Contactor CWMC (400-415V coil)	12615602	\$444.39	\$195.53
CWMC25-10-30X47	15kVAr 25A 3 pole Capacitor Switching Contactor CWMC (400-415V coil)	11486212	\$487.36	\$214.44
CWMC32-10-30X47	25kVAr 32A 3 pole Capacitor Switching Contactor CWMC (400-415V coil)	11486228	\$588.32	\$258.86
CWMC50-10-30X47	40kVAr 50A 3 pole Capacitor Switching Contactor CWMC (400-415V coil)	11486246	\$1,280.85	\$563.57
CWMC65-10-30X47	50kVAr 65A 3 pole Capacitor Switching Contactor CWMC (400-415V coil)	11486271	\$1,470.14	\$646.86
CWMC80-10-30X47	61kVAr 80A 3 pole Capacitor Switching Contactor CWMC (400-415V coil)	12615610	\$1,604.41	\$705.94



Contractor

Other Coil Voltages available on request.

Other Capacitor Voltages available on request

CWBC Contactors (Use if there is no CWMC available)

Item number	Description	SAP number	Trade Price	Contractor Price
Contactors				
CWBC9-21-30D25	10kVAr 9A 3 pole Capacitor Switching Contactor CWBC (230-240V coil)	15765765	\$341.01	\$150.04
CWBC18-21-30D25	16kVAr 18A 3 pole Capacitor Switching Contactor CWBC (230-240V coil)	15765767	\$444.39	\$195.53
CWBC25-21-30D25	20kVAr 25A 3 pole Capacitor Switching Contactor CWBC (230-240V coil)	15765821	\$487.36	\$214.44
CWBC32-21-30D25	25kVAr 32A 3 pole Capacitor Switching Contactor CWBC (230-240V coil)	15765919	\$545.09	\$239.84
CWBC50-21-30D25	40kVAr 50A 3 pole Capacitor Switching Contactor CWBC (230-240V coil)	15765922	\$1,280.85	\$563.57
CWBC65-21-30D25	50kVAr 65A 3 pole Capacitor Switching Contactor CWBC (230-240V coil)	15765924	\$1,470.14	\$646.86
CWBC95-21-30D25	75kVAr 80A 3 pole Capacitor Switching Contactor CWBC (230-240V coil)	16546436	\$1,604.41	\$705.94
CWBC125-21-30E65	100kVAr 103A 3 pole Capacitor Switching Contactor CWBC (230-240V coil)	16995543	\$2,412.65	\$1,061.57
CWBC9-21-30D35	10kVAr 9A 3 pole Capacitor Switching Contactor CWBC (400-415V coil)	15765766	\$341.01	\$150.04
CWBC18-21-30D35	16kVAr 18A 3 pole Capacitor Switching Contactor CWBC (400-415V coil)	15765818	\$444.39	\$195.53
CWBC25-21-30D35	20kVAr 25A 3 pole Capacitor Switching Contactor CWBC (400-415V coil)	15765822	\$487.36	\$214.44
CWBC32-21-30D35	25kVAr 32A 3 pole Capacitor Switching Contactor CWBC (400-415V coil)	15765921	\$545.09	\$239.84
CWBC50-21-30D35	40kVAr 50A 3 pole Capacitor Switching Contactor CWBC (400-415V coil)	15765923	\$1,280.85	\$563.57
CWBC65-21-30D35	50kVAr 65A 3 pole Capacitor Switching Contactor CWBC (400-415V coil)	15765925	\$1,470.14	\$646.86
CWBC95-21-30D35	75kVAr 80A 3 pole Capacitor Switching Contactor CWBC (400-415V coil)	16546437	\$1,604.41	\$705.94
CWBC125-21-30E66	100kVAr 103A 3 pole Capacitor Switching Contactor CWBC (400-415V coil)	16995579	\$2,412.65	\$1,061.57



Contractor

Other Coil Voltages available on request.

Other Capacitor Voltages available on request

INTERFACE RELAYS



Available in voltages of 24/230 V ac/dc
Other voltages available on order



Quick installation



6.2 mm thickness



1 reversible contact



LED indicator



Easy relay connection



Anti-vibration system



BTWR Series

- Terminal Blocks Relays

	Item number	Description	SAP number	Trade Price	Contractor Price
	BTWRP16E26	Interface Relay BTWR 24Vac/dc 1 rev. contact + Ind. LED	12604116	\$59.16	\$58.57
	BTWRP16E31	Interface Relay BTWR 230Vac/dc 1 rev. contact + Ind. LED	12604258	\$90.30	\$89.40

Accessories

	Item number	Description	SAP number	Trade Price	Contractor Price
	PC-BTWR2.5/16R	Cross-connection for BTWR (fits 2 - 16 BTWR)	12635099	\$24.29	\$24.05
	RE-BTWR2.5RC03	Relay Module for BTWR P16E26	12653916	\$24.98	\$24.73
	RE-BTWR2.5RC09	Relay Module for BTWR P16E31	12653915	\$24.98	\$24.73
	BR-BTWR2.5/1RE26	Relay base 24Vac/dc	12635101	\$54.55	\$54.00
Contractor	BR-BTWR2.5/1RE31	Relay base 230Vac/dc	12635106	\$84.68	\$83.83

TERMINAL BLOCKS

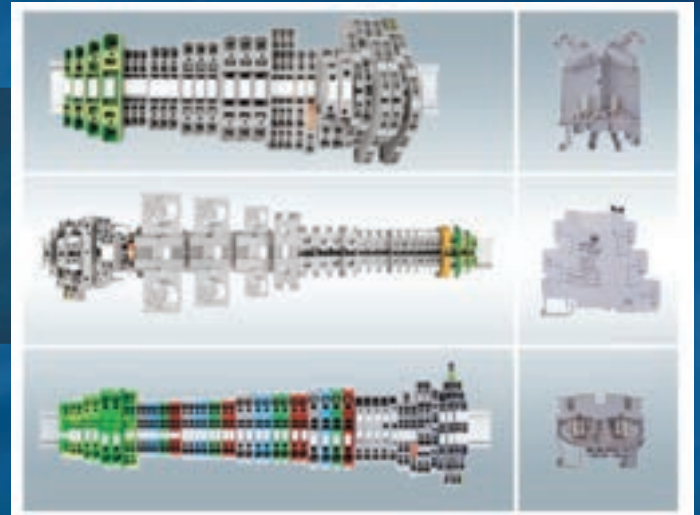

Modularity



Easy Installation



























Versions:

- Screw
- Spring clamp (push-in)
- Spring Clamp
- Screw for cable with ring connector
- Screw for cable with fork connector
- Earth Terminals
- Wide Range of Accessories





Screw Terminal Blocks

Item number	Description	SAP number	Trade Price	Contractor Price	
 BTWP2.5-Cz750V	Screw Terminal 2.5 mm ²	10261734	\$2.50	\$2.00	
BTWP2.5-Az750V	Screw Terminal 2.5 mm ² (blue)	10289144	\$2.50	\$2.00	
BTWP2.5-VD750V	Screw Terminal 2.5 mm ² (green)	10289145	\$2.50	\$2.00	
BTWP2.5-VM750V	Screw Terminal 2.5 mm ² (red)	11458086	\$2.50	\$2.00	
 BTWP4-Cz750V	Screw Terminal 4 mm ²	10261735	\$3.12	\$2.50	
BTWP4-Az750V	Screw Terminal 4 mm ² (blue)	10289146	\$3.12	\$2.50	
BTWP4-VD750V	Screw Terminal 4 mm ² (green)	10289147	\$3.12	\$2.50	
BTWP4-VM750V	Screw Terminal 4 mm ² (red)	11458178	\$3.12	\$2.50	
 BTWP6-Cz630V	Screw Terminal 6 mm ²	10261736	\$3.86	\$3.09	
BTWP6-Az630V	Screw Terminal 6 mm ² (blue)	10289148	\$3.86	\$3.09	
BTWP6-VD630V	Screw Terminal 6 mm ² (green)	10289149	\$3.86	\$3.09	
BTWP6-VM630V	Screw Terminal 6 mm ² (red)	11458179	\$3.86	\$3.09	
 BTWP10-Cz630V	Screw Terminal 10 mm ²	10261737	\$4.92	\$3.94	
BTWP10-Az630V	Screw Terminal 10 mm ² (blue)	10289150	\$4.92	\$3.94	
BTWP10-VD630V	Screw Terminal 10 mm ² (green)	10289151	\$4.92	\$3.94	
BTWP10-VM630V	Screw Terminal 10 mm ² (red)	11458180	\$4.92	\$3.94	
 BTWP16-Cz750V	Screw Terminal 16 mm ²	10261738	\$7.85	\$6.28	
BTWP16-Az750V	Screw Terminal 16 mm ² (blue)	10289152	\$7.85	\$6.28	
BTWP16-VD750V	Screw Terminal 16 mm ² (green)	10289461	\$7.85	\$6.28	
BTWP16-VM750V	Screw Terminal 16 mm ² (red)	11458181	\$7.85	\$6.28	
 BTWP35-Cz750V	Screw Terminal 35 mm ²	10261739	\$15.57	\$12.46	
BTWP35-Az750V	Screw Terminal 35 mm ² (blue)	10289462	\$15.57	\$12.46	
BTWP35-VD750V	Screw Terminal 35 mm ² (green)	10289463	\$15.57	\$12.46	
BTWP35-VM750V	Screw Terminal 35 mm ² (red)	11458182	\$15.57	\$12.46	
 BTWP70-Cz750V	Screw Terminal 70 mm ²	10261740	\$47.33	\$37.86	
BTWP70-AZ750V	Screw Terminal 70 mm ² (blue)	10289464	\$47.33	\$37.86	
BTWP70-VD750V	Screw Terminal 70 mm ² (green)	10289465	\$47.33	\$37.86	
BTWP70-VM750V	Screw Terminal 70 mm ² (red)	11458184	\$47.33	\$37.86	
 BTWP95B-Cz1000V	Screw Terminal 95 mm ²	10261741	\$82.83	\$66.26	
 BTWP150B-CZ1000V	Screw Terminal 150 mm ²	10261742	\$104.86	\$83.89	
 BTWP240B-CZ1000V	Screw Terminal 240 mm ²	10261743	\$143.48	\$114.78	
 BTWP2.5/4T-Vd/Am	Earth Screw Terminal 2.5 - 4 mm ²	10261744	\$11.59	\$9.27	
 BTWP6/10T-Vd/Am	Earth Screw Terminal 6 - 10 mm ²	10261745	\$14.09	\$11.27	
 BTWP16T-Vd/Am	Earth Screw Terminal 16 mm ²	11716372	\$15.45	\$12.36	
 BTWP35T-Vd/Am	Earth Screw Terminal 35 mm ²	11716376	\$24.79	\$19.83	
 BTWD2.5N-Cz500V	Double Screw Terminal 2.5 mm ²	10261747	\$6.60	\$5.28	
 BTWD4N-Cz500V	Double Screw Terminal 4 mm ²	10261748	\$7.97	\$6.38	
 BTWD4NK	Double Screw Terminal 4 mm ² with jumper	11031838	\$18.68	\$14.94	
 BTWT3-CzD36	Triple Screw Terminal 2.5 mm ²	10261749	\$15.33	\$12.26	
 BTWT2T-CzD36	Screw Terminal 2P + earth 2.5 mm ²	10261750	\$17.07	\$13.66	
 BTWT3T-CzD36	Screw Terminal 3P + earth 2.5 mm ²	10261751	\$23.17	\$18.54	
 BTWT3S-Cz500V	Sensor Screw Terminal 2.5 mm ²	10261752	\$14.44	\$11.55	
 BTWS3A-CZ500V	Disconnect Screw Terminal 4 mm ²	10261753	\$11.21	\$8.97	
 BTWS2S-Cz500V	Fuse Screw Terminal 6 mm ² 500V (fuse 5x20 or 5x25mm)	10261754	\$14.95	\$11.96	
 BTWS4S-CZ750V	Fuse Screw Terminal 6 mm ² 750V (fuse 6,35x31,75mm)	10261760	\$18.44	\$14.75	
 BTWS2LD-CZC03	Fuse Screw Terminal 6 mm ² w/ 24 V dc LED (fuse 5x20 or 5x25mm)	10261755	\$27.41	\$21.93	
BTWS2LD-CZD13	Fuse Screw Terminal 6 mm ² w/ 110 V ac LED (fuse 5x20 or 5x25mm)	10847567	\$27.41	\$21.93	
BTWS2LD-CzD23	Fuse Screw Terminal 6 mm ² w/ 220 V ac LED (fuse 5x20 or 5x25mm)	10847581	\$27.41	\$21.93	
Contractor	BTWP4C-CZ750V	Screw Terminal 1IN 2OUT 4 mm ²	10261762	\$8.95	\$7.16

Prices Exclude GST and are subject to change at any time Ref: V24



Screw Terminal Blocks Accessories

Item number	Description	SAP number	Trade Price	Contractor Price
TF-BTWP2.5-10C	End Plate for screw term. block 2.5-10	10261763	\$1.24	\$0.99
TF-BTWP2.5-10(AZ)	End Plate for screw term. block 2.5-10 (blue)	10289466	\$1.24	\$0.99
TF-BTWP2.5-10(VD)	End Plate for screw term. block 2.5-10 (green)	10289467	\$1.24	\$0.99
TF-BTWP2.5-10R	End Plate for screw term. block 2.5-10 (red)	11461173	\$1.24	\$0.99
TF-BTWP2.5-10Y	End Plate for screw term. block 2.5-10 (yellow)	11742898	\$1.24	\$0.99
TF-BTWP16C	End Plate for screw term. block 16	10261764	\$1.76	\$1.41
TF-BTWP16(AZ)	End Plate for screw term. block 16 (blue)	10289468	\$1.76	\$1.41
TF-BTWP16(VD)	End Plate for screw term. block 16 (green)	10261777	\$1.76	\$1.41
TF-BTWP16R	End Plate for screw term. block 16 (red)	11461174	\$1.76	\$1.41
TF-BTWD2.5-4NC	End plate for double screw terminal block BTWD 2.5N. 4N. 4NK	10261765	\$2.87	\$2.30
TF-BTWT3C	End plate for triple screw terminal block BTWT 3	10261766	\$2.92	\$2.34
TF-BTWT2TC	End plate for screw Terminal 2P + earth 2.5	10261767	\$1.81	\$1.45
TF-BTWT3TC	End plate for screw Terminal 3P + earth 2.5	10261768	\$2.34	\$1.87
TF-BTWT3SC	End plate for Sensor Screw Terminal 2.5	10261769	\$2.20	\$1.76
TF-BTWS3C	End plate for disconnect screw terminal 4	10261770	\$1.53	\$1.22
TF-BTWS2C	End plate for fuse screw terminal BTWS 2S. 2LD	10261771	\$2.20	\$1.76
TF-BTWP4C	End plate for screw terminal 1IN 2OUT 4	10261772	\$1.81	\$1.45
TI-BTWP95C	Insulation cover 95 for screw terminal BTW 95B	10261775	\$19.27	\$15.42
TI-BTWP150C	Insulation cover 150 for screw terminal BTW 150B	10261776	\$22.57	\$18.06
TI-BTWP240C	Insulation cover 240 for screw terminal BTW 240B	10288979	\$33.34	\$26.67
PD-BTWP2.5-10C	Partition for screw terminal block BTWP 2.5. 4. 6. 10	10261773	\$1.57	\$1.26
PD-BTWP16C	Partition for screw terminal block BTWP 16	10261774	\$2.02	\$1.62
PS1-BTWPC	Separating Plate for screw terminals	10288980	\$2.40	\$1.92
PC-BTWP2.5/2	Cross-connection (2P) for screw terminal 2.5	10288981	\$3.98	\$3.18
PC-BTWP2.5/3	Cross-connection (3P) for screw terminal 2.5	10288982	\$5.54	\$4.43
PC-BTWP2.5/4	Cross-connection (4P) for screw terminal 2.5	10288983	\$7.22	\$5.78
PC-BTWP2.5/10	Cross-connection (10P) for screw terminal 2.5	10288984	\$17.37	\$13.90
PC-BTWP4/2	Cross-connection (2P) for screw terminal 4	10288985	\$4.63	\$3.70
PC-BTWP4/3	Cross-connection (3P) for screw terminal 4	10288986	\$6.70	\$5.36
PC-BTWP4/4	Cross-connection (4P) for screw terminal 4	10288987	\$8.72	\$6.98
PC-BTWP4/10	Cross-connection (10P) for screw terminal 4	10288988	\$21.16	\$16.93
PC-BTWP6/2	Cross-connection (2P) for screw terminal 6	10288989	\$4.57	\$3.66
PC-BTWP6/3	Cross-connection (3P) for screw terminal 6	10288990	\$6.42	\$5.14
PC-BTWP6/4	Cross-connection (4P) for screw terminal 6	10288991	\$8.42	\$6.74
PC-BTWP6/10	Cross-connection (10P) for screw terminal 6	10288992	\$19.31	\$15.45
PC-BTWP10/2	Cross-connection (2P) for screw terminal 10	10288993	\$6.30	\$5.04
PC-BTWP10/3	Cross-connection (3P) for screw terminal 10	10288994	\$8.74	\$6.99
PC-BTWP10/4	Cross-connection (4P) for screw terminal 10	10288995	\$12.02	\$9.62
PC-BTWP10/10	Cross-connection (10P) for screw terminal 10	10288996	\$26.63	\$21.30
PC-BTWP16/2	Cross-connection (2P) for screw terminal 16	10288997	\$6.25	\$5.00
PC-BTWP16/3	Cross-connection (3P) for screw terminal 16	10288998	\$9.16	\$7.33
PC-BTWP16/4	Cross-connection (4P) for screw terminal 16	10288999	\$12.15	\$9.72
PC-BTWP16/10	Cross-connection (10P) for screw terminal 16	10289000	\$30.05	\$24.04
PC-BTWP35/2	Cross-connection (2P) for screw terminal 35	10289001	\$23.68	\$18.94
PC-BTWP35/3	Cross-connection (3P) for screw terminal 35	10289002	\$28.73	\$22.98
PC-BTWP35/4	Cross-connection (4P) for screw terminal 35	10289003	\$34.92	\$27.94
PC-BTWP35/10	Cross-connection (10P) for screw terminal 35	10289004	\$50.75	\$40.60
PC-BTWT2.5/2	Cross-connection 2.5 (2P) for screw terminal BTWT 2T. 3T. 3S. 3	10289005	\$3.79	\$3.03
PC-BTWT2.5/3	Cross-connection 2.5 (3P) for screw terminal BTWT 2T. 3T. 3S. 3	10289006	\$5.97	\$4.78
PC-BTWT2.5/4	Cross-connection 2.5 (4P) for screw terminal BTWT 2T. 3T. 3S. 3	10289007	\$8.08	\$6.46
PC-BTWT2.5/10	Cross-connection 2.5 (10P) for screw terminal BTWT 2T. 3T. 3S. 3	10289008	\$18.75	\$15.00

Contractor

Prices Exclude GST and are subject to change at any time Ref: V24



Push-In Spring Terminal Blocks

	Item number	Description	SAP number	Trade Price	Contractor Price
	BTW12.5	Push-In Spring Terminal 2.5 mm ²	11992035	\$2.70	\$2.62
	BTW12.5-AZ	Push-In Spring Terminal 2.5 mm ² (blue)	11992332	\$2.70	\$2.62
	BTW12.5-VD	Push-In Spring Terminal 2.5 mm ² (green)	11992333	\$2.70	\$2.62
	BTW12.5-VM	Push-In Spring Terminal 2.5 mm ² (red)	11992334	\$2.70	\$2.62
	BTW4	Push-In Spring Terminal 4 mm ²	11992036	\$3.88	\$3.76
	BTW4-AZ	Push-In Spring Terminal 4 mm ² (blue)	11992335	\$3.88	\$3.76
	BTW4-VD	Push-In Spring Terminal 4 mm ² (green)	11992336	\$3.88	\$3.76
	BTW4-VM	Push-In Spring Terminal 4 mm ² (red)	11992337	\$3.88	\$3.76
	BTW6	Push-In Spring Terminal 6 mm ²	11992037	\$5.83	\$5.66
	BTW6-AZ	Push-In Spring Terminal 6 mm ² (blue)	11992358	\$5.83	\$5.66
	BTW6-VD	Push-In Spring Terminal 6 mm ² (green)	11992362	\$5.83	\$5.66
	BTW6-VM	Push-In Spring Terminal 6 mm ² (red)	11992374	\$5.83	\$5.66
	BTW10	Push-In Spring Terminal 10 mm ²	11992178	\$8.19	\$7.94
	BTW10-AZ	Push-In Spring Terminal 10 mm ² (blue)	11992375	\$8.19	\$7.94
	BTW10-VD	Push-In Spring Terminal 10 mm ² (green)	11992377	\$8.19	\$7.94
	BTW10-VM	Push-In Spring Terminal 10 mm ² (red)	11992408	\$8.19	\$7.94
	BTW12.5T-VD/AM	Push-In Earth Spring Terminal 2.5 mm ²	11992179	\$8.19	\$7.94
	BTW4T-VD/AM	Push-In Earth Spring Terminal 4 mm ²	11992181	\$11.31	\$10.97
	BTW6T-VD/AM	Push-In Earth Spring Terminal 6 mm ²	11992182	\$11.46	\$11.12
	BTW10T-VD/AM	Push-In Earth Spring Terminal 10 mm ²	11992185	\$16.69	\$16.19
	BTW12.5CT-VD/AM	Push-In Double Earth Spring Terminal 2.5 mm ²	11992331	\$13.05	\$12.66
	BTW12.5-2F	Double Push-In Spring Terminal 2.5 mm ²	11992186	\$7.23	\$7.01
	BTW4-2F	Double Push-In Spring Terminal 4 mm ²	11992187	\$7.95	\$7.71
	BTW4-2FK	Double Push-In Spring Terminal 4 mm ²	11992220	\$19.74	\$19.15
	BTW12.5-3F	Triple Push-In Spring Terminal 2.5 mm ²	11992222	\$14.87	\$14.42
	BTW12.5-2FT	Push-In Spring Terminal 2P+T 2.5 mm ²	11992224	\$19.27	\$18.69
	BTW12.5-3FT	Push-In Spring Terminal 3P+T 2.5 mm ²	11992225	\$23.00	\$22.31
	BTW13S	Sensor Push-In Spring Terminal 2.5 mm ²	11992227	\$7.70	\$7.47
	BTW12.5A	Disconnect Push-In Spring Terminal 2.5 mm ²	11992238	\$12.04	\$11.68
	BTWIS	Fuse Push-In Spring Terminal 4 mm ² (fuse 5x20 or 5x25mm)	11992246	\$14.66	\$14.22
	BTWII	Fuse Push-In Spring Terminal 4 mm ² (fuse 6,35x31,75mm)	11992328	\$16.33	\$15.84
	BTWISLDC03	Fuse Push-In Spring Terminal 4 mm ² w/ 24 V dc/cc LED	11992409	\$26.42	\$25.63
	BTWISLDD13	Fuse Push-In Spring Terminal 4 mm ² w/ 110 V ac/ca LED	11992412	\$26.42	\$25.63
	BTWISLDD23	Fuse Push-In Spring Terminal 4 mm ² w/ 220 V ac/ca LED	11992247	\$26.42	\$25.63
	BTW12.5E	Spring Push-In Terminal 1IN 2OUT 2.5 mm ²	11992329	\$4.70	\$4.56
	BTW12.5C	Spring Push-In Terminal 2IN 2OUT 2.5 mm ²	11992330	\$6.25	\$6.06

Contractor



Push -In Spring Terminal Blocks Accessories













Item number	Description	SAP number	Trade Price	Contractor Price
TF-BTWI2.5	End plate for Push-In spring terminal block 2.5	11991377	\$1.05	\$0.84
TF-BTWI2.5-AZ	End plate for Push-In spring terminal block 2.5 (blue)	11991492	\$1.05	\$0.84
TF-BTWI2.5-VD	End plate for Push-In spring terminal block 2.5 (green)	11991494	\$1.05	\$0.84
TF-BTWI2.5-VM	End plate for Push-In spring terminal block 2.5 (red)	11991493	\$1.05	\$0.84
TF-BTWI4	End plate for Push-In spring terminal block 4	11991459	\$1.48	\$1.18
TF-BTWI4-AZ	End plate for Push-In spring terminal block 4 (blue)	11991495	\$1.48	\$1.18
TF-BTWI4-VD	End plate for Push-In spring terminal block 4 (green)	11991496	\$1.48	\$1.18
TF-BTWI4-VM	End plate for Push-In spring terminal block 4 (red)	11991498	\$1.48	\$1.18
TF-BTWI6	End plate for Push-In spring terminal block 6	11991460	\$1.65	\$1.32
TF-BTWI6-AZ	End plate for Push-In spring terminal block 6 (blue)	11991499	\$1.65	\$1.32
TF-BTWI6-VD	End plate for Push-In spring terminal block 6 (green)	11991501	\$1.65	\$1.32
TF-BTWI6-VM	End plate for Push-In spring terminal block 6 (red)	11991502	\$1.65	\$1.32
TF-BTWI10	End plate for Push-In spring terminal block 10	11991462	\$1.81	\$1.45
TF-BTWI10-AZ	End plate for Push-In spring terminal block 10 (blue)	11991503	\$1.81	\$1.45
TF-BTWI10-VD	End plate for Push-In spring terminal block 10 (green)	11991504	\$1.81	\$1.45
TF-BTWI10-VM	End plate for Push-In spring terminal block 10 (red)	11991505	\$1.81	\$1.45
TF-BTWI2.5T	End plate for earth Push-In spring terminal 2.5	12165379	\$1.05	\$0.84
TF-BTWI4T	End plate for earth Push-In spring terminal 4	12165380	\$1.48	\$1.18
TF-BTWI6T	End plate for earth Push-In spring terminal 6	12165383	\$1.65	\$1.32
TF-BTWI10T	End plate for earth Push-In spring terminal 10	12165384	\$1.81	\$1.45
TF-BTWI2.5CT	End plate for double Push-In spring terminal BTWI 2,5 CT	11991491	\$2.03	\$1.62
TF-BTWI2.5-2F	End plate for double Push-In spring terminal BTWI 2,5 -2F	11991463	\$1.57	\$1.26
TF-BTWI4-2F	End plate for triple Push-In spring terminal BTWI 4 -2F	11991464	\$2.06	\$1.65
TF-BTWI2.5-3F	End plate for Push-In spring terminal BTWI 2,5 -3F	11991465	\$3.46	\$2.77
TF-BTWI2.5-3FT	End plate for sensor Push-In spring terminal BTWI 2,5 -3FT	11991466	\$3.46	\$2.77
TF-BTWI3S	End plate for disconnect Push-In spring terminal BTWI 3S	11991467	\$3.49	\$2.79
TF-BTWI2.5A	End plate for fuse Push-In spring terminal BTWI 2,5 A	11991488	\$6.98	\$5.58
TF-BTWI2.5E	End plate for Push-In spring terminal BTWI 2,5 E	11991489	\$2.12	\$1.70
TF-BTWI2.5C	End plate for Push-In spring terminal BTWI 2,5 C	11991490	\$3.69	\$2.95
PC-BTWM2.5/2	Cross-connection (2P) for spring terminal 2.5	10289044	\$2.12	\$1.70
PC-BTWM2.5/3	Cross-connection (3P) for spring terminal 2.5	10289045	\$3.49	\$2.79
PC-BTWM2.5/4	Cross-connection (4P) for spring terminal 2.5	10289046	\$3.98	\$3.18
PC-BTWM2.5/10	Cross-connection (10P) for spring terminal 2.5	10289047	\$8.97	\$7.18
PC-BTWM4/2	Cross-connection (2P) for spring terminal 4	10289048	\$2.87	\$2.30
PC-BTWM4/3	Cross-connection (3P) for spring terminal 4	10289049	\$3.98	\$3.18
PC-BTWM4/4	Cross-connection (4P) for spring terminal 4	10289050	\$4.62	\$3.70
PC-BTWM4/10	Cross-connection (10P) for spring terminal 4	10289051	\$9.47	\$7.58
PC-BTWM6/2	Cross-connection (2P) for spring terminal 6	10289052	\$3.24	\$2.59
PC-BTWM6/3	Cross-connection (3P) for spring terminal 6	10289053	\$4.48	\$3.58
PC-BTWM6/4	Cross-connection (4P) for spring terminal 6	10289054	\$5.98	\$4.78
PC-BTWM6/10	Cross-connection (10P) for spring terminal 6	10289055	\$12.70	\$10.16
PC-BTWM10/2	Cross-connection (2P) for spring terminal 10	10289056	\$5.48	\$4.38
PC-BTWM10/3	Cross-connection (3P) for spring terminal 10	10289057	\$8.47	\$6.78
PC-BTWM10/4	Cross-connection (4P) for spring terminal 10	10289058	\$10.60	\$8.48
PC-BTWM10/10	Cross-connection (10P) for spring terminal 10	10289059	\$23.55	\$18.84

Contractor

Prices Exclude GST and are subject to change at any time Ref: V24



Spring Terminal Blocks

	Item number	Description	SAP number	Trade Price	Contractor Price
	BTWM2.5-CZ750V	Spring Terminal 2.5 mm ²	10289013	\$2.80	\$2.72
	BTWM2.5-AZ750V	Spring Terminal 2.5 mm ² (blue)	10289583	\$2.80	\$2.72
	BTWM2.5-VD750V	Spring Terminal 2.5 mm ² (green)	10289584	\$2.80	\$2.72
	BTWM2.5-VM750V	Spring Terminal 2.5 mm ² (red)	11458186	\$2.80	\$2.72
	BTWM4-Cz750V	Spring Terminal 4 mm ²	10289014	\$3.98	\$3.86
	BTWM4-Az750V	Spring Terminal 4 mm ² (blue)	10289585	\$3.98	\$3.86
	BTWM4-VD750V	Spring Terminal 4 mm ² (green)	10289586	\$3.98	\$3.86
	BTWM4-VM750V	Spring Terminal 4 mm ² (red)	11458187	\$3.98	\$3.86
	BTWM6-Cz750V	Spring Terminal 6 mm ²	10289015	\$6.19	\$6.00
	BTWM6-AZ750V	Spring Terminal 6 mm ² (blue)	10289587	\$6.19	\$6.00
	BTWM6-VD750V	Spring Terminal 6 mm ² (green)	10289588	\$6.19	\$6.00
	BTWM6-VM750V	Spring Terminal 6 mm ² (red)	11458198	\$6.19	\$6.00
	BTWM10-CZ750V	Spring Terminal 10 mm ²	10289016	\$8.50	\$8.25
	BTWM10-Az750V	Spring Terminal 10 mm ² (blue)	10289589	\$8.50	\$8.25
	BTWM10-VD750V	Spring Terminal 10 mm ² (green)	10289590	\$8.50	\$8.25
	BTWM10-VM750V	Spring Terminal 10 mm ² (red)	11458199	\$8.50	\$8.25
	BTWM2.5T-VD/AM	Earth Spring Terminal 2.5 mm ²	10289017	\$8.97	\$8.70
	BTWM4T-VD/AM	Earth Spring Terminal 4 mm ²	10289018	\$11.59	\$11.24
	BTWM6T-VD/AM	Earth Spring Terminal 6 mm ²	10289019	\$11.83	\$11.48
	BTWM10T-Vd/Am	Earth Spring Terminal 10 mm ²	10289020	\$17.43	\$16.91
	BTWM2.5CT-Vd/Am	Double earth Spring Terminal 2.5 mm ²	10289960	\$14.33	\$13.90
	BTWM2.5-2F-Cz500V	Double Spring Terminal 2.5 mm ²	10289021	\$7.47	\$7.25
	BTWM4-2F-Cz750V	Double Spring Terminal 4 mm ²	10289022	\$8.10	\$7.86
	BTWM4-2FK	Double Spring Terminal 4 mm ²	11031843	\$20.07	\$19.47
	BTWM2.5-3F-CZ500V	Triple Spring Terminal 2.5 mm ²	10289023	\$15.33	\$14.87
	BTWM2.5-2FT-CZ500V	Spring Terminal 2P+T 2.5 mm ²	10289024	\$20.18	\$19.57
	BTWM2.5-3FT-Cz500V	Spring Terminal 3P+T 2.5 mm ²	10289025	\$25.65	\$24.88
	BTWM3S-CZ500V	Sensor Spring Terminal 2.5 mm ²	10289026	\$7.97	\$7.73
	BTWM2.5A-CZ750V	Disconnect Spring Terminal 2.5 mm ²	10289027	\$12.34	\$11.97
	BTWMS-Cz500V	Fuse Spring Terminal 4 mm ² (fuse 5x20 or 5x25mm)	10289028	\$16.19	\$15.70
	BTWMI-Cz500V	Fuse Spring Terminal 4 mm ² (fuse 6,35x31,75mm)	10289030	\$18.94	\$18.37
	BTWMSLD-CZC03	Fuse Spring Terminal 6 mm ² w/ 24 V dc/cc LED	10289029	\$43.59	\$42.28
	BTWMSLD-CZD13	Fuse Spring Terminal 6 mm ² w/ 110 V ac/ca LED	10847582	\$43.59	\$42.28
	BTWMSLD-CzD23	Fuse Spring Terminal 6 mm ² w/ 220 V ac/ca LED	10847583	\$43.59	\$42.28
Contractor	BTWM2.5E-CZ750V	Spring Terminal 1IN 2OUT 2.5 mm ²	10289958	\$5.23	\$5.07
	BTWM2.5C-Cz750V	Spring Terminal 2IN 2OUT 2.5 mm ²	10289959	\$6.47	\$6.28



Spring Terminal Blocks Accessories

Item number	Description	SAP number	Trade Price	Contractor Price
TF-BTWM2.5C	End plate for spring terminal block 2.5	10289963	\$1.11	\$0.89
TF-BTWM2.5(AZ)	End plate for spring terminal block 2.5 (blue)	10289591	\$1.11	\$0.89
TF-BTWM2.5(VD)	End plate for spring terminal block 2.5 (green)	10289592	\$1.11	\$0.89
TF-BTWM2.5R	End plate for spring terminal block 2.5 (red)	11461175	\$1.11	\$0.89
TF-BTWM4C	End plate for spring terminal block 4	10289964	\$1.49	\$1.19
TF-BTWM4(AZ)	End plate for spring terminal block 4 (blue)	10289593	\$1.49	\$1.19
TF-BTWM4(VD)	End plate for spring terminal block 4 (green)	10289594	\$1.49	\$1.19
TF-BTWM4R	End plate for spring terminal block 4 (red)	11461177	\$1.49	\$1.19
TF-BTWM6C	End plate for spring terminal block 6	10289965	\$1.74	\$1.39
TF-BTWM6(AZ)	End plate for spring terminal block 6 (blue)	10289595	\$1.74	\$1.39
TF-BTWM6(VD)	End plate for spring terminal block 6 (green)	10289596	\$1.74	\$1.39
TF-BTWM6R	End plate for spring terminal block 6 (red)	11461208	\$1.74	\$1.39
TF-BTWM10C	End plate for spring terminal block 10	10289966	\$1.90	\$1.52
TF-BTWM10(AZ)	End plate for spring terminal block 10 (blue)	10289597	\$1.90	\$1.52
TF-BTWM10(VD)	End plate for spring terminal block 10 (green)	10261778	\$1.90	\$1.52
TF-BTWM10R	End plate for spring terminal block 10 (red)	11461210	\$1.90	\$1.52
TF-BTWM2.5T	End plate for earth spring terminal 2.5	10289042	\$2.12	\$1.70
TF-BTWM4T	End plate for earth spring terminal 4	12165387	\$1.86	\$1.49
TF-BTWM6T	End plate for earth spring terminal 6	12165389	\$2.14	\$1.71
TF-BTWM10T	End plate for earth spring terminal 10	12165390	\$2.19	\$1.75
TF-BTWM2.5-2F	End plate for double spring terminal 2.5 BTWM 2.5-2F	10289032	\$2.62	\$2.10
TF-BTWM4-2FC	End plate for double spring terminal 6 BTWM4-2FK	10289033	\$2.62	\$2.10
TF-BTWM2.5-3FC	End plate for triple spring terminal 2.5 BTWM2.5-3F	10289034	\$3.12	\$2.50
TF-BTWM2.5-3FT	End plate for spring terminal 2P+T 2.5 BTWM2.5-2FT, 3FT	10289036	\$3.12	\$2.50
TF-BTWM3SC	End plate for sensor spring terminal 2.5 BTWM3S	10289037	\$3.05	\$2.44
TF-BTWM2.5AC	End plate for disconnect spring terminal 2.5 BTWM2.5A	10289038	\$1.49	\$1.19
TF-BTWM5-IC	End plate for fuse spring terminal BTWM S, SLD, I	10289039	\$2.12	\$1.70
TF-BTWM2.5EC	End plate for spring terminal 1IN 2OUT 2.5 BTWM2.5E	10289040	\$1.63	\$1.30
TF-BTWM2.5CC	End plate for spring terminal 2IN 2OUT 2.5 BTWM2.5C	10289041	\$1.65	\$1.32
PC-BTWM2.5/2	Cross-connection (2P) for spring terminal 2.5	10289044	\$2.12	\$1.70
PC-BTWM2.5/3	Cross-connection (3P) for spring terminal 2.5	10289045	\$3.49	\$2.79
PC-BTWM2.5/4	Cross-connection (4P) for spring terminal 2.5	10289046	\$3.98	\$3.18
PC-BTWM2.5/10	Cross-connection (10P) for spring terminal 2.5	10289047	\$8.97	\$7.18
PC-BTWM4/2	Cross-connection (2P) for spring terminal 4	10289048	\$2.87	\$2.30
PC-BTWM4/3	Cross-connection (3P) for spring terminal 4	10289049	\$3.98	\$3.18
PC-BTWM4/4	Cross-connection (4P) for spring terminal 4	10289050	\$4.62	\$3.70
PC-BTWM4/10	Cross-connection (10P) for spring terminal 4	10289051	\$9.47	\$7.58
PC-BTWM6/2	Cross-connection (2P) for spring terminal 6	10289052	\$3.24	\$2.59
PC-BTWM6/3	Cross-connection (3P) for spring terminal 6	10289053	\$4.48	\$3.58
PC-BTWM6/4	Cross-connection (4P) for spring terminal 6	10289054	\$5.98	\$4.78
PC-BTWM6/10	Cross-connection (10P) for spring terminal 6	10289055	\$12.70	\$10.16
PC-BTWM10/2	Cross-connection (2P) for spring terminal 10	10289056	\$5.48	\$4.38
PC-BTWM10/3	Cross-connection (3P) for spring terminal 10	10289057	\$8.47	\$6.78
PC-BTWM10/4	Cross-connection (4P) for spring terminal 10	10289058	\$10.60	\$8.48
PC-BTWM10/10	Cross-connection (10P) for spring terminal 10	10289059	\$23.55	\$18.84

Prices Exclude GST and are subject to change at any time Ref: V24



Terminal Blocks Accessories

Item number	Description	SAP number	Trade Price	Contractor Price
IDB5-BTWH0	Printed Tags IDB5 (0 x 50) horizontal print for terminal block	10792234	\$10.78	\$8.62
IDB5-BTWH1	Printed Tags IDB5 (1 x 50) horizontal print for terminal block	10795114	\$10.78	\$8.62
IDB5-BTWH2	Printed Tags IDB5 (2 x 50) horizontal print for terminal block	10795183	\$10.78	\$8.62
IDB5-BTWH3	Printed Tags IDB5 (3 x 50) horizontal print for terminal block	10795196	\$10.78	\$8.62
IDB5-BTWH4	Printed Tags IDB5 (4 x 50) horizontal print for terminal block	10795212	\$10.78	\$8.62
IDB5-BTWH5	Printed Tags IDB5 (5 x 50) horizontal print for terminal block	10795219	\$10.78	\$8.62
IDB5-BTWH6	Printed Tags IDB5 (6 x 50) horizontal print for terminal block	10795250	\$10.78	\$8.62
IDB5-BTWH7	Printed Tags IDB5 (7 x 50) horizontal print for terminal block	10795255	\$10.78	\$8.62
IDB5-BTWH8	Printed Tags IDB5 (8 x 50) horizontal print for terminal block	10795258	\$10.78	\$8.62
IDB5-BTWH9	Printed Tags IDB5 (9 x 50) horizontal print for terminal block	10795267	\$10.78	\$8.62
IDB5-BTWH10	Printed Tags IDB5 (10 x 50) horizontal print for terminal block	10795284	\$10.78	\$8.62
IDB5-BTWH1-10	Printed Tags IDB5 (1-10 x 5) horizontal print for terminal block	10795289	\$10.78	\$8.62
IDB5-BTWH11-20	Printed Tags IDB5 (11-20 x 5) horizontal print for terminal block	10795291	\$10.78	\$8.62
IDB5-BTWH21-30	Printed Tags IDB5 (21-30 x 5) horizontal print for terminal block	10795303	\$10.78	\$8.62
IDB5-BTWH31-40	Printed Tags IDB5 (31-40 x 5) horizontal print for terminal block	10795373	\$10.78	\$8.62
IDB5-BTWH41-50	Printed Tags IDB5 (41-50 x 5) horizontal print for terminal block	10795411	\$10.78	\$8.62
IDB5-BTWH1-50	Printed Tags IDB5 (1-50 x 1) horizontal print for terminal block	10795444	\$10.78	\$8.62
IDB5-BTWH51-100	Printed Tags IDB5 (51-100 x 1) horizontal print for terminal block	10795446	\$10.78	\$8.62
IDB5-BTWH-101-150	Printed Tags IDB5 (101-150 x 1) horizontal print for terminal block	11070272	\$10.78	\$8.62
IDB5-BTWH-151-200	Printed Tags IDB5 (151-200 x 1) horizontal print for terminal block	11070512	\$10.78	\$8.62
IDB5-BTWH-201-250	Printed Tags IDB5 (201-250 x 1) horizontal print for terminal block	11070562	\$10.78	\$8.62
IDB5-BTWH-251-300	Printed Tags IDB5 (251-300 x 1) horizontal print for terminal block	11070514	\$10.78	\$8.62
IDB5-BTWH-301-350	Printed Tags IDB5 (301-350 x 1) horizontal print for terminal block	11070515	\$10.78	\$8.62
IDB5-BTWH-351-400	Printed Tags IDB5 (351-400 x 1) horizontal print for terminal block	11070516	\$10.78	\$8.62
IDB5-BTWH-401-450	Printed Tags IDB5 (401-450 x 1) horizontal print for terminal block	11070559	\$10.78	\$8.62
IDB5-BTWH-451-500	Printed Tags IDB5 (451-500 x 1) horizontal print for terminal block	11070560	\$10.78	\$8.62
IDB5-BTWHR	Printed Tags IDB5 (R x 50) horizontal print for terminal block	10795481	\$10.78	\$8.62
IDB5-BTWH S	Printed Tags IDB5 (S x 50) horizontal print for terminal block	10795483	\$10.78	\$8.62
IDB5-BTWH T	Printed Tags IDB5 (T x 50) horizontal print for terminal block	10795512	\$10.78	\$8.62
IDB5-BTWH U	Printed Tags IDB5 (U x 50) horizontal print for terminal block	10795614	\$10.78	\$8.62
IDB5-BTWH V	Printed Tags IDB5 (V x 50) horizontal print for terminal block	10795616	\$10.78	\$8.62
IDB5-BTWH W	Printed Tags IDB5 (W x 50) horizontal print for terminal block	10795620	\$10.78	\$8.62
IDB5-BTWH	Blank Tags IDB5 (x 50) for terminal block	10290300	\$0.24	\$0.19
IDB5-BTWH+	Printed Tags IDB5 (+ x 50) horizontal print for terminal block	10795622	\$10.78	\$8.62
IDB5-BTWH-	Printed Tags IDB5 (- x 50) horizontal print for terminal block	10795624	\$10.78	\$8.62
PF3-BTWC	End Bracket PF3 for terminal block	10289060	\$2.57	\$2.06
PF4-BTWC	End Bracket PF4 for terminal block	10289061	\$3.45	\$2.76
IG22-BTWH	Group Identifier for end bracket PF4-BTW	10290296	\$5.43	\$4.34
IG-BTWG	Group Identifier	10289062	\$3.64	\$2.91
MR7.5x30x2000	Mounting rail DIN 35 mm (2 m)	11476763	\$43.77	\$35.02
ST-BTW	Rail support DIN	10290297	\$9.50	\$7.60

Contractor



CB Series Busbar Connectors

	Item number	Description	SAP number	Trade Price	Contractor Price	
	CB4-BTW-Cz	Bus Bar Connector cross-section 4 mm ²	10289075	\$4.24	\$1.48	
	CB4N-BTW-AZ	Bus Bar Connector cross-section 4 mm ² (blue)	10289078	\$5.98	\$2.09	
	CB4PE-BTW-VD/AM	Bus Bar Connector cross-section 4 mm ² (green-yellow)	10289081	\$5.98	\$2.09	
	CB10-BTW-Cz	Bus Bar Connector cross-section 10 mm ²	10289076	\$6.23	\$2.18	
	CB10N-BTW-AZ	Bus Bar Connector cross-section 10 mm ² (blue)	10289079	\$8.47	\$2.96	
	CB10PE-BTW-VD/AM	Bus Bar Connector cross-section 10 mm ² (green-yellow)	10289082	\$8.47	\$2.96	
	CB35-BTW-CZ	Bus Bar Connector cross-section 35 mm ²	10289077	\$14.95	\$5.23	
	CB35N-BTW-AZ	Bus Bar Connector cross-section 35 mm ² (blue)	10289080	\$17.43	\$6.10	
	CB35PE-BTW-VD/AM	Bus Bar Connector cross-section 35 mm ² (green-yellow)	10289083	\$17.43	\$6.10	
	BR3x10x1000	Busbar copper 3x10 (1 m)	10667823	\$386.09	\$135.13	
	Contractor	SB-BTWBG	Busbar support block	10289084	\$5.98	\$2.09